

OPTONICA

LED Lighting for everyone



Showroom und Verkauf Frankfurt

www.optonicaled.shop

Hausener Weg 61

60489 Frankfurt

Mail: sales@optonicaled.shop

Who we are:

OPTONICA is a rapidly evolving trade company, established in 2011 in Bulgaria, and recognized as a leader in the technologies of tomorrow: LED LIGHTING and SOLAR ENERGY. Over the years, we have built a strong reputation as a trusted importer, supplier, and partner by delivering innovative, reliable, and sustainable solutions. Our team is composed of highly qualified experts who are passionate about technology and continuously strive to improve their knowledge and skills. By combining experience with innovation, we aim to remain at the forefront of the global energy and lighting revolution.

Mission:

Our mission is to meet the growing demand for efficient, environmentally responsible, and cost-effective energy solutions. We are committed to serving the needs of our customers and partners with a wide variety of LED lighting products and solar panel systems that offer long-term value and measurable benefits. Precision, quality, and customer satisfaction are our guiding principles, and we consider every project an opportunity to demonstrate our dedication to excellence.

Scope of work:

As one of the main importers and distributors on the Bulgarian market, OPTONICA offers one of the richest and most versatile assortments of LED lighting products and solar panels. We work closely with internationally renowned manufacturers and technology leaders, ensuring that our customers have access to the latest and most advanced solutions available. Our product portfolio covers residential, commercial, industrial, and public applications, helping individuals, businesses, and communities transition toward sustainable and energy-efficient living.

What we offer:

- A new generation of LED lighting with a wide range of applications: homes, offices, retail spaces, hotels, public and administrative buildings, schools, hospitals, industrial sites, parks, sports facilities, garages, parking lots, billboards, and much more.
- High-quality solar panel systems designed to deliver reliable and sustainable energy for residential rooftops, commercial buildings, industrial projects, and off-grid installations.
- Consistently uncompromising product quality with warranties of up to 5 years, ensuring peace of mind and long-term performance.
- Ecological and environmentally friendly solutions that support 100% recyclability and contribute to a greener planet.
- A broad and carefully maintained stock of products for fast and reliable delivery.
- Attractive, stable, and mutually beneficial terms for our partners and distributors.
- Full technical support, professional consultations, and after-sales service tailored to the needs of every client.
- A professional, responsible, and customer-oriented approach that guarantees trust, reliability, and successful long-term cooperation.

Our vision for the future:

We believe that the future belongs to sustainable technologies. By combining our expertise in LED lighting and solar energy, OPTONICA is dedicated to offering solutions that reduce energy consumption, lower costs, and protect the environment. Our goal is to continue growing as a trusted leader and to inspire individuals, businesses, and communities to embrace a brighter, cleaner, and more sustainable future.

LED Lighting for everyone !

www.optonicaled.shop
Tel: 01637512845



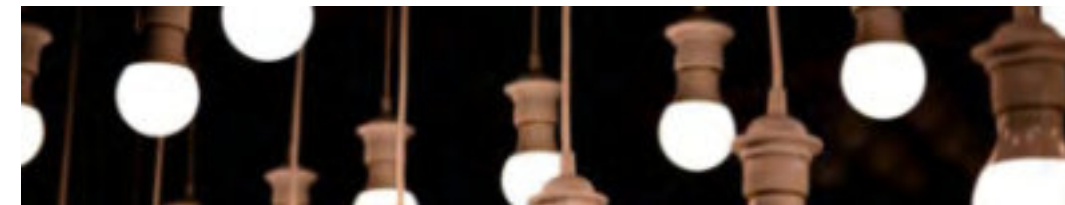

Solar Systems

04 -25

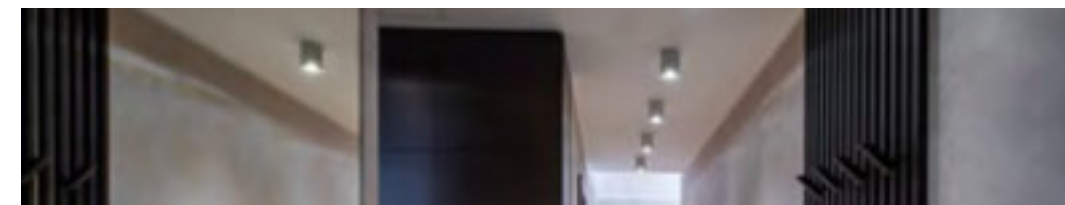

LED Bulbs & Spotlights

26 -55



Spotlight Fixtures

56 -69



LED Pendants & Fans

70 -97

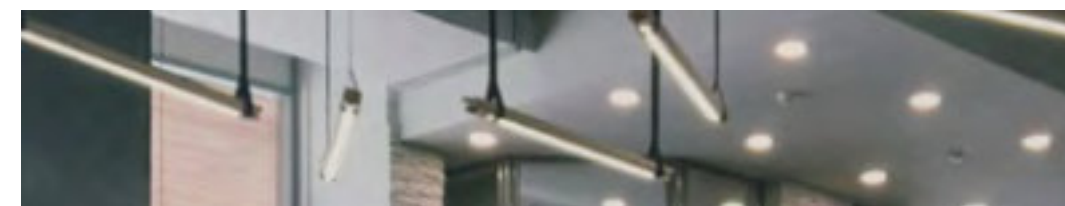

LED Tubes & Fixtures

98 -111



LED Emergency Lighting

112 -117

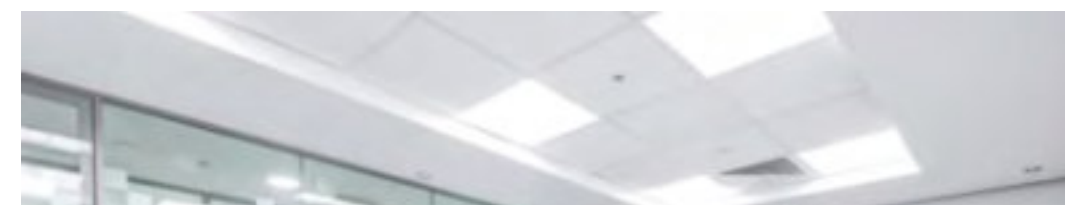

LED Panels

118 -129

	LED Surface & Mini Panels 130 -143
--	---------------------------------------

	LED Ceiling Lights 144 -167
--	--------------------------------

	LED Downlights 168 -175
--	----------------------------

	LED Strips & Flex Neon 176 -203
---	------------------------------------

	Strip Accessories and Profiles 204 -211
--	--

	LED Power Supplies 212 -221
--	--------------------------------

	LED Controllers 222 -243
--	-----------------------------

	LED Linear & Track Lights 244 -269
---	---------------------------------------

	LED Floodlights 270 -285
---	-----------------------------

	LED Street & Industrial Lights 286 -301
---	--

	LED Wall & Step Lights 203 -301
--	------------------------------------

	LED Outdoor & Garden Lights 316 -335
---	---

	Sensors 336 -341
---	---------------------

	Miscellaneous and Comfort Products 342 -356
---	--



What components make up a solar panel system?

Solar panel installations are very straightforward systems. There are only four main components to any solar panel system, and no moving parts, making them very efficient to install and maintain. The four components of a solar panel system are:

Solar photovoltaic panels –to convert solar energy into electricity

Battery –to store DC electricity

Inverters –to convert DC electricity into AC electricity

Racking and mounting systems –to affix your solar panels to your roof (or to the ground, depending upon your installation type)

Performance monitoring systems –to track and monitor the output and health of your solar panels and inverters

DESIGN AND CONSTRUCTION OF SOLAR POWER SYSTEMS

The photovoltaic panels we offer are designed to be highly efficient and with long service life, which makes them a great choice for those who want yet to invest in renewable energy for homes or your business.

Green energy solutions



How does solar power work?

Solar power works by converting energy from the sun into power. There are two forms of energy generated from the sun for our use – electricity and heat. Both are generated through the use of solar panels, which range in size from residential rooftops to ‘solar farms’ stretching over acres of rural land.

Is solar power a clean energy source?

Yes, solar power is a renewable and infinite energy source that creates no harmful greenhouse gas emissions – as long as the sun continues to shine, energy will be released. The carbon footprint of solar panels is already quite small, as they last for 25 years plus with no loss in efficiency. And the materials used in the panels are increasingly recycled, so the carbon footprint will continue to shrink.

When was solar power discovered?

Solar energy was used by humans as early as the 7th century B.C., when humans used sunlight to light fires by reflecting the sun’s rays onto shiny objects. Later, in 3rd century B.C., the Greeks and Romans harnessed solar power with mirrors to light torches for religious ceremonies. In 1839 and at the age of just 19, French physicist Edmond Becquerel discovered the photovoltaic (PV) effect while experimenting with a cell made of metal electrodes in a conducting solution. He noted that the cell produced more electricity when it was exposed to light – it was a photovoltaic cell. In 1954 PV technology was born when Daryl Chapin, Calvin Fuller and Gerald Pearson developed the silicon PV cell at Bell Labs in 1954 – the first solar cell capable of absorbing and converting enough of the sun’s energy into power to run everyday electrical equipment. Today satellites, spacecraft orbiting Earth, are powered by solar energy.

How exactly is electricity from solar energy produced?

Solar panels are usually made from silicon installed in a metal panel frame with a glass casing. When photons, or particles of light, hit the thin layer of silicon on the top of a solar panel, they knock electrons off the silicon atoms. This PV charge creates an electric current (specifically, direct current or DC), which is captured by the wiring in solar panels. This DC electricity is then converted to alternating current (AC) by an inverter. AC is the type of electrical current used when you plug appliances into normal wall sockets.



PORTABLE POWER STATION

PURE SINE WAVE AC OUTPUT

Cell Capacity	400W/320Wh	600W/512Wh	1000W/1036.8Wh	2000W/2096Wh
DC Input	12V-24V/0-10A(120WMax)	12V-24V/0-10A(120WMax)	12V-24V/0-10A(200WMax)	12V-65V/30A(650WMax)
AC Output	230Vac 400W	230Vac 600W	230Vac 1000W	230Vac 2000W
DC Output	12V/0-10A	12V/0-10A	12V/0-10A	12V/0-10A
Cigar Socket Output	13.3V/10A	13.3V/10A	13.3V/10A	13V/10A
USB-A Output	5V/2.4A	5V/2.4A	5V/2.4A	5V/2.4A
USB-C Output	20V/3AMax	20V/5AMax	20V/5AMax	20V/5AMax
LED Flashlight	3W	3W	3W	3W
Wireless Charge	No	No	No	Yes (20W Max)
SKU	9418	9419	9420	9421
Power	400W	600W	1000W	2000W

BAGS FOR PORTABLE STATION

Ideal for quick transportation

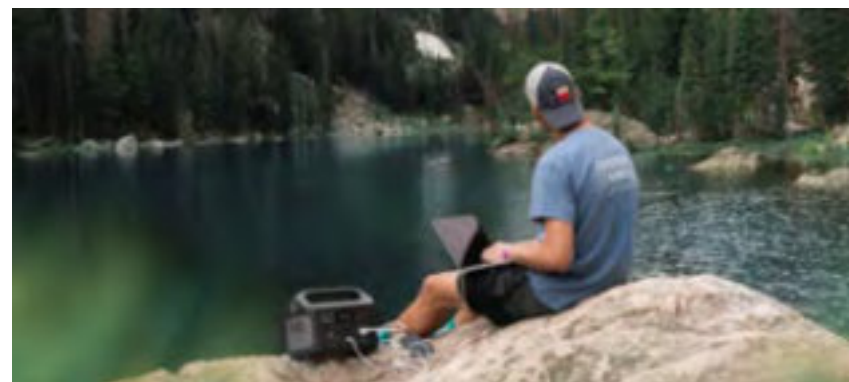

SKU	9429	9428	9422	9423
For Station	400W	600W	1000W	2000W



PORTABLE SOLAR PANEL

Monocrystalline -Foldable

Power	120Wp	200Wp	400Wp
Output 1	MC4 18V/6.6AMax	MC4 18V/11.1AMax	MC4 36V/6.6AMax
Output 2	USB-A QC 3.0 24W Max	USB-A QC 3.0 24W Max	-
Output 3	Type-CPD45W Max	Type-CPD45W Max	-
Material	ETFE-Film	ETFE-Film	ETFE-Film

SKU	9400	9401	9402
Power	120Wp	200Wp	400Wp



SKU	9424	SKU	9425	SKU	9426	SKU	9427
	MC4 Convert to Anderson		MC4 Convert to DC5525		Anderson convert to DC5525		YBranchConnector1to 2MC4Y2



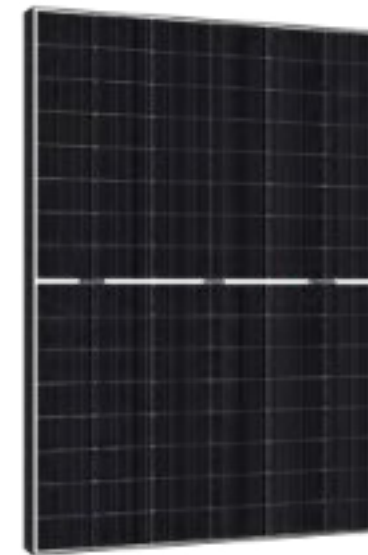
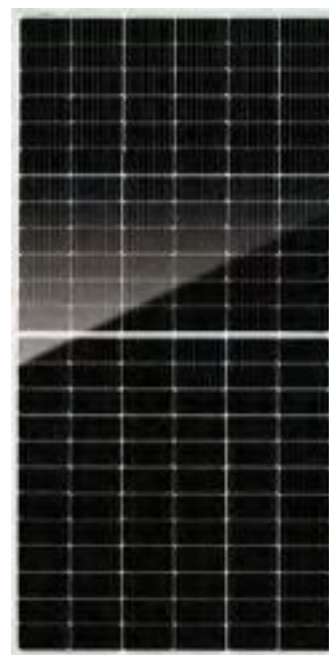

PV SOLAR PANELS -N TYPE

Monocrystalline -MC4 Cables



TIER1 Bloomberg NEW ENERGY FINANCE	MONO HALF-CUT MODULE BLACK FRAME	MONO HALF-CUT MODULE SILVER FRAME	BIFACIAL MONO PERC MODULE	DOUBLE-GLASS BIFACIAL -TOPCON
	MBB 182mmCell	MBB 166mmCell	MBB 182mmCell	MBB 182mmCell
PV Model	UL-405-108HV	UL-455M-144HV	UL-550M-144HV	UL-570M-144DG
Rated Max Power	405Wp	455Wp	550Wp	570Wp
Voltage Pmax Vmp	31.3V	41.1V	41.9V	42.2V
Current Pmax IMP	12.94A	11.07A	13.13A	13.51A
Open-Circuit Current Voc	37.3V	49.9V	50V	50.7V
Short-Circuit Current Isc	13.69A	11.64A	13.75A	14.23A
Maximum Voltage	1500V	1500V	1500V	1500V
Maximum Fuse Rating	25A	25A	30A	30A
Module Efficiency STC	20.74%	20.93%	21.28%	22.07%
Dimensions	2279x1134x35mm	2094x1038x35mm	2279x1134x35mm	2278x1134x35mm
SKU	9411	9410	9412	9413



Lower LCOE
Lower shading and resistive loss
Lower temperature coefficient



Anti-PID (potential induced degradation)
Passed anti-PID test under 85% damp heat,
85% relative humidity for 96 hours

PV SOLAR PANELS P-TYPE

Monocrystalline -MC4 Cables



TIER1 Bloomberg NEW ENERGY FINANCE	BIFACIAL BLACK FRAME N-TYPE TOPCON	BIFACIAL N-TYPE TOPCON	HYPER-ION BIFACIAL N-TYPE TOPCON HDJ HJT
	PV Model	SPDG450-N96R12	ODA-132MHDRz
Rated Max Power	450Wp	620Wp	700Wp
Voltage Pmax Vmp	29.93V	40.74V	49.83V
Current Pmax IMP	15.04A	115.29A	17.82A
Open-Circuit Current Voc	35.8V	49.28V	41.78V
Short-Circuit Current Isc	15.9A	16.08A	16.77A
Maximum Voltage	1500V	1500V	1500V
Maximum Fuse Rating	30A	35A	25A
Module Efficiency STC	22.52%	23%	22.5%
Dimensions	1762x1134x30mm	2382x1134x30mm	2384x1303x33mm
SKU	9416	9408	9415

· Double glass
· Black frame
· Bifacial transparent

· SMBB Technology
· PID Resistance
· Higher Power Output
· Enhanced Mechanical Load

· Ultra-high bifacial factor
· Excellent anti-LID & anti-PID performance
· No B-O caused LID

JinKO Solar

NEW

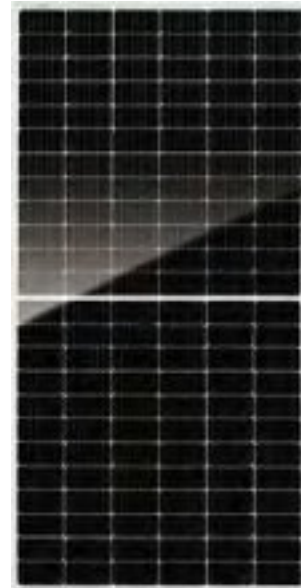
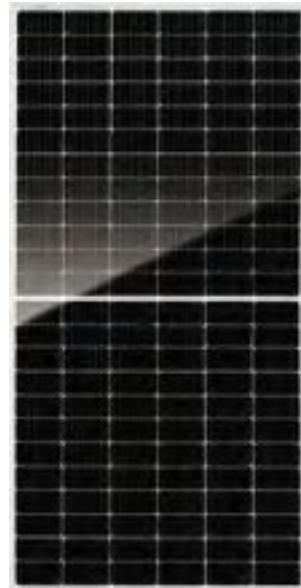

PV SOLAR PANELS

Monocrystalline -MC4 Cables



N-TYPE TIGER NEW
MONO-FACIAL

P-TYPE TIGER NEW
MONO-FACIAL

PV Model	JKM450-54HL4R	JKM550M-72HL4
Rated Max Power	450Wp	550Wp
Voltage Pmax Vmp	33.21V	40.9V
Current Pmax IMP	13.55A	13.45A
Open-Circuit Current Voc	39.78V	49.62V
Short-Circuit Current Isc	14A	14.03A
Maximum Voltage	1000/1500V	1000/1500V
Maximum Fuse Rating	25A	25A
Module Efficiency STC	22.52%	20.93%
Dimensions	1762x1134x30mm	2278x1134x35mm
SKU	9701	9702

MICRO INVERTER

OUTPUT -600W

Input: 2*MC4 /PV 2*210-400W
Output: 230Vac 600W
MPPT: 25-55V2*13A
Unit: 212x230x40mm3.15kg



SKU 9431

SKU 9451
PV Cable -100m -4mm²



SKU 9453
PV Cable -100m -6mm²



SKU 9452
PV Cable -100m -4mm²



SKU 9454
PV Cable -100m -6mm²



SKU 9459
Grounding Cable -100m -4mm²



SKU 9433
1.5M 4MM2 WITH MC4



SKU 9457
Y-BRANCH 1500V, 30A -3Y



SKU 9458
Y-BRANCH 1500V, 30A -4Y



SKU 9455
MC4 1to1 1000v,30A



SKU 9456
MC4 1to1 1500v,30A



SKU 9434
END CAP FOR MALE CONNECTOR



SKU 9432
BC01 ANDSCHUKO PLUG





HYBRID INVERTERS
High Voltage -THREE PHASE



	10KW	15KW	20KW	30KW	50KW	80KW
Model	SUN-10K-SG01 HP3-EU-AM2	SUN-15K-SG01 HP3-EU-AM2	SUN-20K-SG01 HP3-EU-AM2	SUN-30K-SG01 HP3-EU-BM3	SUN-50K-SG01 HP3-EU-BM4	SUN-80K-SG02 HP3-EU-EM8
Battery VoltageRange (V)	160~700	160~700	160~700	160~800	160~800	160~100
Max. Charging Current (A)	37	37	37	50+50	50+50	80+80
Max. DCInputPower (W)	13000	19500	26000	39000	65000	160000
Start-upVoltage (V)	180	180	180	180	180	180
MPPT Range(V)	150-850	150-850	150-850	150-850	150-850	150-850
No.ofMPP Trackers	2	2	2	3	4	6
Full Load DC Voltage (V)	325-850	420-850	500-850	360-850	450-850	650
PV Input Current(A)	20+20	26+20	26+26	36+36+36	36+36+36+36	36+36+36+36+36+36
No.of Strings per MPP Tracker	1+1	2+1	1+2	2+2+2	2+2+2+2	2+2+2+2+2+2
Rated AC OutputPower (W)	10000	15000	20000	30000	50000	80000
AC OutputRated Current (A)	15.2/14.5	22.8/21.8	30.4/29	45.5/43.5	75.8/72.5	121.3/115.9
Max. AC OutputCurrent (A)	16.7/16	25/24	33.4/31.9	50/47.8	83.4/79.7	121.3/115.9
Grid Type	ThreePhase	ThreePhase	ThreePhase	ThreePhase	ThreePhase	ThreePhase
Max. Efficiency	97.6%	97.6%	97.6%	97.6%	97.6%	97.6%
MPPT Efficiency	99.90%	99.90%	99.90%	99.90%	99.90%	>99%
SKU	9448	9449	9442	9443	9444	9450 NEW



HYBRID INVERTERS
Low Voltage -THREE PHASE



	6KW	8KW	10KW	12KW
Model	SUN-6K- SG04LP3-EU	SUN-8K- SG04LP3-EU	SUN-10K- SG04LP3-EU	SUN-12K- SG04LP3-EU
Battery VoltageRange (V)	40-60	40-60	40-60	40-60
Max. Charging Current (A)	150	190	210	240
Max. DCInputPower (W)	7800	10400	13000	15600
Start-upVoltage (V)	160	160	160	160
MPPT Range(V)	200-650	200-650	200-650	200-650
No.ofMPP Trackers	2	2	2	3
Full Load DC Voltage (V)	350-650	350-650	350-650	350-650
PV Input Current(A)	20+20	26+20	26+26	36+36+36
No.of Strings per MPP Tracker	1+1	1+1	2+1	2+1
Rated AC OutputPower (W)	6000	8000	10000	12000
AC OutputRated Current (A)	9.1/8.7	12.1/11.6	15.2/14.5	18.2/17.4
Max. AC OutputCurrent (A)	10/9.6	13.4/12.8	16.7/15.9	20/19.1
Grid Type	ThreePhase	ThreePhase	ThreePhase	ThreePhase
Max. Efficiency	97.6%	97.6%	97.6%	97.6%
MPPT Efficiency	99.90%	99.90%	99.90%	99.90%
SKU	9445	9436	9435	9441



Scan for moreinfo

HYBRID INVERTERS
Low Voltage -SINGLE PHASE

Italian Market



	3.6KW	5KW	6KW	6KW	8KW	10KW	12KW	16KW
Model	SUN-3.6K-SG03LP1-EU	SUN-5K-SG03LP1-EU	SUN-6K-SG05LP1-EU	SUN-6K-SG03LP1-EU	SUN-8K-SG01LP1-EU	SUN-10K-SG02LP1-EU-AM3	SUN-12K-SG02LP1-EU-AM3	SUN-16K-SG01LP1-EU
Battery VoltageRange (V)	40-60	40-60	40-60	40-60	40-60	40-60	40-60	40-60
Max. Charging Current (A)	90	120	135	135	190	220	250	290
Max. DCInputPower (W)	4680	6500	7800	7800	10400	16000	19200	20800
Start-upVoltage (V)	125	125	125	125	125	125	125	125
MPPT Range(V)	150-425	150-425	150-425	125-425	125-425	150-425	150-425	150-425
No.ofMPP Trackers	2	2	2	2	2	3	3	3
Full Load DC Voltage (V)	500	300-425	300-425	300-425	200-425	500	500	500
PV Input Current(A)	13+13	13+13	13+13	13+13	26+26	20+20	20+20	26+26+26
No.of Strings -MPP Tracker	1+1	1	1	1	2+2	3/2+2+2	3/2+2+2	2
Rated AC OutputPower (W)	3600	5000	6000	6000	8000	10000	12000	16000
AC OutputRated Current (A)	16.4/15.7	22.7/21.7	27.3/26.1	27.3/26.1	36.4/34.8	45.5/43.5	54.6/52.2	69.6
Max. AC OutputCurrent (A)	18/17.2	25/23.9	30/28.7	30/28.7	40/38.3	45.5/43.5	54.6/52.2	100
Grid Type	Single Phase	Single Phase	Single Phase	Single Phase	Single Phase	Single Phase	Single Phase	Single Phase
Max. Efficiency	97.6%	97.6%	97.6%	97.6%	97.6%	97.6%	97.6%	97.6%
MPPT Efficiency	>99%	99.90%	99.90%	99.90%	99.90%	99.90%	99.90%	99.90%

SKU	9446	9437	9440	9438	9447	9751	9752	9753
	NEW					NEW	NEW	NEW



Scan for moreinfo

ON GRID INVERTERS 400V
THREEPHASE



	8KW	10KW	30KW	50KW	100KW
Model	XG8KTR	XG10KTR	XG30KTR	XG50KTR	XG100KTR
Max. InputPower	12.8kW	16kW	48kW	80kW	150kW
Max. Input Voltage	1100V	1100V	1100V	1100V	1100V
Start Voltage	160V	160V	250V	250V	250V
Rated Input Voltage	600V	600V	600V	600V	620V
Full-loadMPP Voltage Range	320V-850V	450V-850V	500V-800V	520V-850V	530V-850V
MPPT VoltageRange	180V-1000V	180V-1000V	200V-1000V	200V-1000V	180V-1000V
Numberof MPP Trackers	2	2	3	4	9
Max. Currentper MPPT	14A/14A	14A/14A	26A	39A/26A/39A/26A	26A
Max. Output Current	12.8A	15.9A	48.3A	79.7A	158.8A
Rated OutputPower	8kW	10kW	30kW	50kW	100kW
Max. OutputPower	8.8kVA	11kVA	33.3kVA	55kVA	110kVA
Rated Grid Voltage	230Vac/400Vac	230Vac/400Vac	230Vac/400Vac	230Vac/400Vac	230Vac/400Vac
THDi	<3%	<3%	<3%	<3%	<3%
Max. Efficiency	98.70%	98.70%	98.6%	98.7%	98.6%
MPPT Efficiency	99.90%	99.90%	99.90%	99.90%	99.90%

SKU	9481	9482	9483	9484	9485



Scan for moreinfo



Scan for moreinfo



All-in-One Energy Storage System

5kW Inverter&5.32kWh Battery -SINGLE PHASE

Model	RW-F5.3-1H3
OutputActive Power (W)	5000
AC OutputRated Current (A)	22.8 / 21.8
Max.PV Access Power(W)	10000
Start UpPV Voltage (Vdc)	125
MPPT VoltageRange (Vdc)	150-425
Battery Nominal Voltage (V)	51.2
Battery Energy Configuration(kWh)	5.32
Battery OperatingVoltage (V)	44.8-57.6

SKU 9430

ON GRID INVERTERS
THREEPHASE



SKU 9495
WIFI DONGLE FOR KSTAR INVERTERS

	10KW	30KW	40KW	120KW
Model	BluE-10KT	KSG-30KT	KSG-40KT	KSG-120CL
Max. DC Voltage	1100V	1100V	1100V	1100V
Nominal Voltage	620V	600V	600V	620V
Start Voltage	180V	180V	180V	250V
MPPT VoltageRange	140V-1000V	200V-1000V	200V-1000V	200V-1000V
Numberof MPPT Tracker	2	3	3	10
StringsPer MPPT Tracker	1	2	2	2
Max. InputCurrentPer MPPT	15A	30A	30A	30A
Max. Short-circuitCurrentPer MPPT	20A	50A	50A	50A
Nominal AC OutputPower	10000W	30000W	40000W	120kW
MaximumAC OutputPower	11000VA	33000VA	44000VA	121kVA
Nominal AC Voltage	400V 3L+N	400V 3L+N	400V 3L+N	320-480V 3W+PE
Maximum Output Current	16A	47.7A	63.6A	174.6A
THDi	<3%	<3%	<3%	<3%
Max. Efficiency	98.7%	98.7%	98.7%	98.7%
Euro Efficiency	98.1%	98.4%	98.4%	98.3%
SKU	9491	9492	9493	9494



C&I Battery Cabinet

Without inverter

Model	GE-F60
Module Energy(kWh)	5.12
Module NominalVoltage (V)	51.2
Module Capacity (Ah)	100
System Nominal Voltage (V)	614.4
System OperatingVoltage (V)	480-700
System Energy (kWh)	61.44
Charge/Discharge Current(A)	100
Dimension	735x1045x2235mm

SKU 9791



C&I Battery Cabinet

With 50KW Hybrid Inverter -THREE PHASE

Model	GE-F120-2H2
Nominal OutputPower (W)	40000
Max PV InputPower (W)	52000
Start Up DCVoltage (Vdc)	180
MPPT VoltageRange (Vdc)	150-850
Battery OperatingVoltage (V)	500-700
Battery Nominal Voltage (V)	51.2
Battery Module Energy(kWh)	5.12
Energy Configuration (kWh)	122.8

SKU 9792

1. STANDARD 19 INCH RACK

For 12Pcs Batteries and 1Pcs Controller

SKU 9475

Dimensions: 589x590x2240mm



1



2



3

2. BATTERIES RACK MOUNTING

High Voltage

Operating Voltage	120-750 VDC
Charge/Discharge Current	100A
MAX Charge/Discharge Current	125A
DC Input Rating	12±2%/4.15A
Dimension	440*570*150mm

SKU 9476

3. BATTERY MODULES 5.12KWH

High Voltage LiFePO4 - Rack Mounting

Model	BOS-GM5.1
Nominal Capacity	100 Ah
Nominal Energy	5.12kWh
Nominal Voltage	51.2VDC
Charge/Discharge Current	100A

SKU 9477



BATTERIES

Low Voltage LiFePO4

Cell	EVE	EVE
Nominal Capacity	100 Ah	200 Ah
Nominal Energy	10.2kWh	10.2kWh
Nominal Voltage	51.2VDC	51.2VDC
Charge/Discharge Current	100A	150A

SKU 9473 9472



BATTERIES RACK MOUNTING

Low Voltage LiFePO4

Model	VE48100E-P2
Nominal Capacity	100 Ah
Nominal Energy	5.12kWh
Nominal Voltage	51.2VDC
Charge/Discharge Current	100A
Warranty	10 Years

SKU 9470



BATTERIES

Low Voltage LiFePO4

Model	RW-M6.1-B	RW-F10.2
Nominal Capacity	120 Ah	200 Ah
Nominal Energy	6.14Wh	10.2kWh
Nominal Voltage	51.2VDC	51.2VDC
Charge/Discharge Current	60A	100A

SKU 9439 9488 **NEW**

SKU 9465

SET FOR BATTERY 9471-9473



SKU 9469

SLAVE CABLE KIT FOR SKU:9470



SKU 9468

EXTERNAL RACK FOR SKU:9470



SKU 9468C

EXTERNAL COVER FOR SKU:9470



NEW



BATTERIES

Low Voltage LiFePO4 - Stackable

Model	SE-G5.1-PRO-B
Nominal Capacity	100 Ah
Nominal Energy	5.12kWh
Nominal Voltage	51.2VDC
Charge/Discharge Current	100A

SKU 9474

NEW

Deye



1. BATTERY CLUSTER CONTROLBOX

High Voltage -BOS-G PRO

Model	BOS-G-PDU-2
Operating Voltage	120-1000 VDC
Charge/Discharge Current	100A
MAX Charge/Discharge Current	125A
DC InputRating	12±2%/4.15A
Dimension	440*570*150mm

SKU 9478

2. BATTERY MODULE5.12KWH

High Voltage LiFePO4 -Rack Mounting -BOS-G PRO

Model	BOS-G-Pack5.1
Nominal Capacity	100 Ah
Nominal Energy	5.12kWh
Nominal Voltage	51.2VDC
Charge/Discharge Current	100A

SKU 9479



2



Scan for moreinfo

1. STANDARD19 INCH RACK

For 13Pcs Batteries and 1Pcs Controller

SKU 9775

Dimensions: 589x590x2240mm

NEW

Deye



1



2



3



1. BATTERY CLUSTER CONTROLBOX

High Voltage -BOS-A

Model	BOS-A-PDU-2
Operating Voltage	436.8-569.4 VDC
Charge/Discharge Current	100A
MAX Charge/Discharge Current	160A
Module Capacity (Ah)	200Ah
Dimension	440*570*150mm

SKU 9776

2. BATTERY MODULE5.12KWH

High Voltage LiFePO4 -Rack Mounting -BOS-A

Model	BOS-A
Nominal Capacity	200 Ah
Nominal Energy	7.68kWh
Nominal Voltage	38.4VDC
Charge/Discharge Current	100A

SKU 9777

SKU 9466

CT for Smart Meter 3-Phase



3 Years Warranty



Smart Meters Kits for INVT 3-PhaseInverters

Including wires and CT SDT024TS

Model	STD670V
Voltage	3x5A, 3x16A, 3x32A, 3x63A & 3x100A
Current	2x110V/220V, 3x57.7/100V, 3x127/220V, 3x220V/380V, 3x230V/400V, 3x100V, 3x380V

SKU 9460

3 Years Warranty



Multi-FunctionElectrical Energy Meter

SINGLE PHASE

Nominal Voltage	120V or 230V AC
Basic current	10A
Maximum rated current	100A
Bi-directional measurement	Yes
Operating Voltage	80%-120%

SKU 9461

3 Years Warranty



Multi-FunctionElectrical Energy Meter

THREPHASE

Nominal Voltage	3x230/400V ac
Basic current	10A
Maximum rated current	100A
Bi-directional measurement	Yes
Operating Voltage	80%-120%

SKU 9462

3 Years Warranty



Multi-FunctionElectrical Energy Meter

THREE PHASE -CT & PT operated

Nominal Voltage	3x230/400V ac
Basic current	10A
Maximum rated current	100A
Bi-directional measurement	Yes
Operating Voltage	60%-120%

SKU 9463



PV MODULEOPTIMIZER
SUN-XL02-B

Maximum input power(W)	700
Maximum input voltage(V)	80
MPPT voltagerange(V)	12-80
Maximum inputcurrent (A)	15

SKU 9498

!CANNOTWORK WITHOUT CONCENTRATORSKU:9497!



OPTIMIZER CONCENTRATOR
SUN-XL20-B

Maximum Input Current (A)	20
System (V)	1000/1500
Connected Strings	4
Connector	MC4

SKU 9497

!CANNOTWORK WITHOUTOPTIMIZER SKU:9498!



PV MODULEOPTIMIZER
SUNGO-OPT

Maximum input power(W)	700
Maximum input voltage(V)	80
MPPT voltagerange(V)	16-80
Maximum inputcurrent (A)	15

SKU 9499



Scan for moreinfo

PV MODULEOPTIMIZER
SUNGO-OPT

Maximum input power(W)	600
Maximum input voltage(V)	60
MPPT voltagerange(V)	7-60
Maximum inputcurrent (A)	16

SKU 9464



Scan for moreinfo



SKU 9656 AC220V or 110V

SKU 9657 AC220V or 110V +DC24 Supply(Battery)

DOUBLEHEADEDPV CLEANING BRUSH
5.5m Glass Fiber Handle 220VAC or110VAC

Utilization Voltage	24V
Power	52.8W*2
Speed	128rpm
Torsion	1.2 N.m
Brush Size	280mm

Accessories:
Adapter ,Water pipe and accessories ,Backpack ,Telescopic rod, Brush head assembly set (including 1pcbrushdiscs)



SOLAR PANEL CLEANING ROBOT
Single or DoublePV Panel





































PV Module Range	Up to 2384mmSingle /Double
TravelingSpeed	15-20m/min
GeneratorPower	150W/200W
Water Used Per Hour	330
Solar Panel Power	27W
Battery Capacity (Ah)	24V10Ah / 20Ah
Cleaning Mode	Dry/Watering Cleaning
Other Functions	Speed Adjust/DirectionAdjust



SKU 9658 Single PV Panel 150W 24V10Ah

SKU 9659 DoublePV Panel 200W 24V20Ah



<p>SKU 9601 Rail 27*45mm -2.2m</p> 	<p>SKU 9602 Rail 27*45mm -1.2m</p> 	<p>SKU 9618 300mmMini Rail</p> 	<p>SKU 9619 2400mmLong Rail</p> 	<p>SKU 9603 End Clamp M8x25mm</p> 	<p>SKU 9621 End Clamp M8x25mm for 30mm</p> 	<p>SKU 9623 End Clamp for 30mm</p> 	<p>SKU 9630 Ball Nut 20mm</p> 		
<p>SKU 9610 Rail Joiner 200mm</p> 	<p>SKU 9620 Rail+Rubber+Screws 70x80x18.5mm</p> 	<p>SKU 9613 Adjustable Rear Leg 10-15°</p> 	<p>SKU 9614 Adjustable Rear Leg 15-30°</p> 	<p>SKU 9604 Middle Clamp 35mm</p> 	<p>SKU 9624 Middle Clamp M8x35 for 30mm</p> 	<p>SKU 9622 Middle Clamp 20mmWide</p> 	<p>SKU 9606 TT Nut M8x25mm</p> 		
<p>SKU 9612 Adjustable FrontLeg</p> 	<p>SKU 9616 Adjustable Tilt Mount Bracket</p> 	<p>SKU 9632 Triangle Bracket 3850x1500x547mm</p> 	<p>SKU 9635 Hook with4pcs self DrillingScrews</p> 	<p>SKU 9625 Inner Bolt 40mm</p> 	<p>SKU 9626 Inner Bolt 25mm</p> 	<p>SKU 9627 M8 Hexagonal Nut</p> 	<p>SKU 9628 M8 Square Nut</p> 		
<p>SKU 9609 L-Foot M8*25mm</p> 	<p>SKU 9611 Hanger Bolt with L-Foot</p> 	<p>SKU 9633 Rail Clamp 40mm</p> 	<p>SKU 9605 Rooftop Hook</p> 	<p>SKU 9631 Sel TappingScrew ST5.5*25mm</p> 	<p>SKU 9607 Screw ST6.3*80mm</p> 	<p>SKU 9608 Wood Screw M6.3*80mm</p> 			
<p>SKU 9617 Ballasted Strip 446x80x18.5mm</p> 	<p>SKU 9634 Ballast Pan forSKU:9632</p> 	<p>SKU 9615 GroundingPlate</p> 	<p>SKU 9629 Expansion Bolt 60mm</p> 						

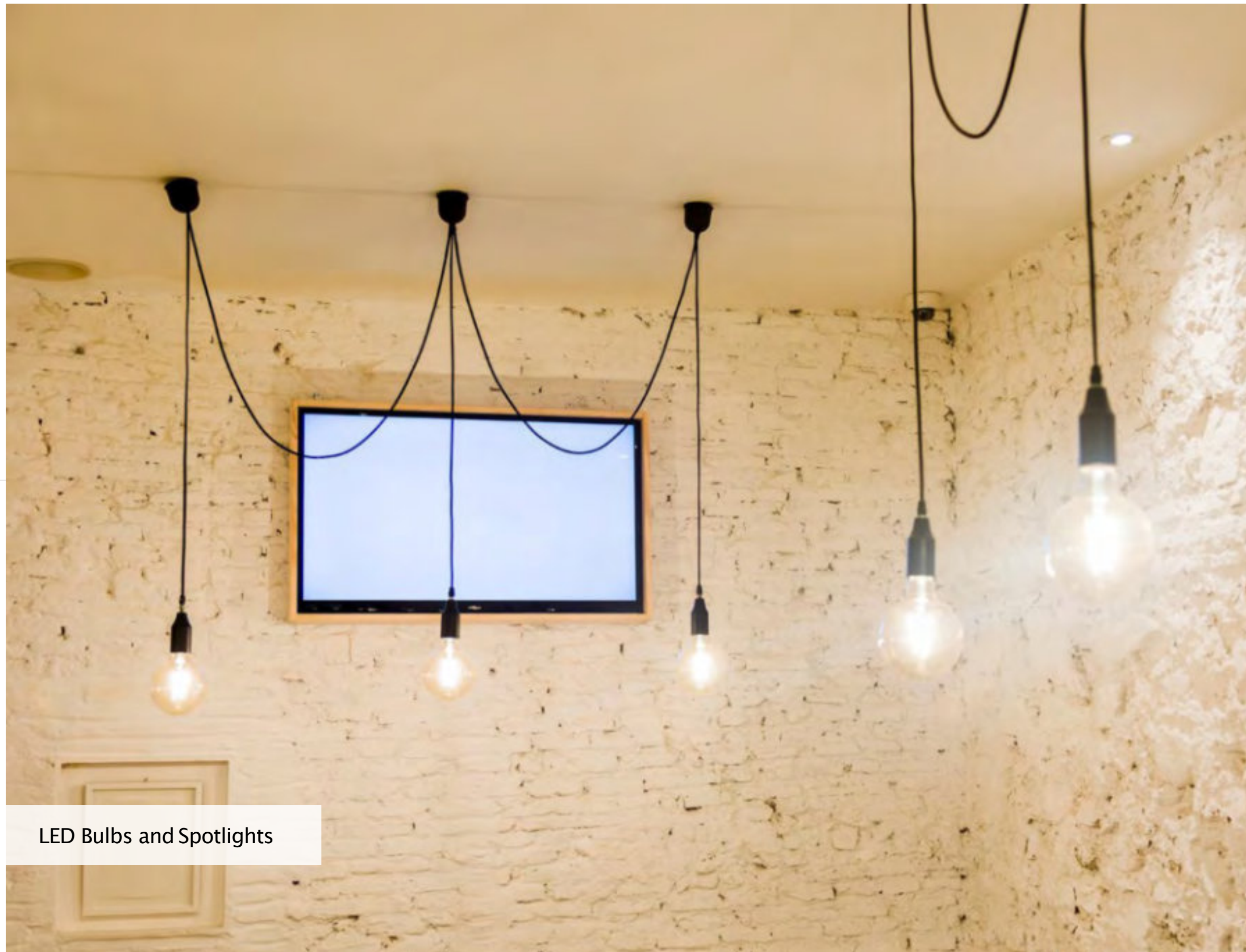

LED Bulbs and Spotlights

Our advanced LED bulbs bring together cutting-edge efficiency, durability, and style. Designed to replace traditional lighting without compromise, they provide a warm and welcoming glow while helping to reduce energy costs and environmental impact. Perfect for modern living, they combine everyday practicality with a timeless aesthetic that complements any space — from cosy homes to elegant restaurants and lively bars.

Features:

- Upto 90% lower energy consumption compared to incandescent bulbs
- Extra-long lifespan for fewer replacements and reduced maintenance
- Consistent, flicker-free light that's gentle on the eyes
- Wider range of colour temperatures from warm to cool white
- Universal E27 socket compatibility
- Available in classic bulb shapes and contemporary designs

Applications:

- General lighting for living rooms, kitchens, and bedrooms
- Stylish accent lighting in cafés, shops, and restaurants
- Decorative use in chandeliers, pendants, or wall fixtures
- Reliable performance in enclosed or covered outdoor fittings



LED SPOTLIGHT G4
2W SMD

Watts	2W	CRI	Ra>80
Input Voltage	AC / DC 12V	IP Rating	IP20
Flux	180lm	Dimension	ø12x29mm
Beam Angle	300°	Material	Platic
Socket	G4	Dimmable	No

SKU	1601	1602	1603
Color	6000K	4500K	2800K



LED SPOTLIGHT G4
2W SMD

Watts	2W	CRI	Ra>80
Input Voltage	AC / DC 12V	IP Rating	IP20
Flux	170lm	Dimension	ø10x30mm
Beam Angle	360°	Material	Platic
Socket	G4	Dimmable	No

SKU	1615	1616	1617
Color	6000K	4500K	2700K



LED SPOTLIGHT G4/MR11
3W SMD

Watts	3W	CRI	Ra>80
Input Voltage	AC DC 12V	IP Rating	IP20
Flux	210lm	Dimension	ø35x45mm
Beam Angle	38°	Material	Platic
Socket	G4	Dimmable	No

SKU	1066	1067	1068
Color	6000K	4500K	2700K



LED SPOTLIGHT G9
3.5W SMD

Watts	3.5W	CRI	Ra>80
Input Voltage	AC220-240V 50Hz	IP Rating	IP20
Flux	400lm	Dimension	ø16x50mm
Beam Angle	360°	Material	Ceramic
Socket	G9	Dimmable	No

SKU	1651	1652	1653
Color	6000K	4500K	2700K



LED SPOTLIGHT G9
Plastic

Socket	G9	CRI	Ra>80
Input Voltage	AC170-265V 50Hz	IP Rating	IP20
Beam Angle	360°	Dimmable	No

SKU	Watt	Lumen	Lumen/W	Color	Dimension
1638	3W	220lm	73lm/W	6000K	ø16x48mm
1639	3W	220lm	73lm/W	4500K	ø16x48mm
1640	3W	220lm	73lm/W	2700K	ø16x48mm
1635	5W	420lm	84lm/W	6000K	456x120x83mm
1636	5W	420lm	84lm/W	4000K	456x120x83mm
1637	5W	400lm	84lm/W	2700K	456x120x83mm



LED SPOTLIGHT G9
Dimmable

Socket	G9	CRI	Ra>80
Input Voltage	AC220-240V 50Hz	IP Rating	IP20
Beam Angle	360°	Dimmable	YES

SKU	Watt	Lumen	Lumen/W	Color	Dimension
1654	4W	400lm	100lm/W	6000K	ø16x50mm
1655	4W	400lm	100lm/W	4500K	ø16x50mm
1656	4W	400lm	100lm/W	2700K	ø16x50mm
1644	6W	550lm	92lm/W	6000K	ø18x64mm
1645	6W	550lm	92lm/W	4000K	ø18x64mm
1646	6W	550lm	92lm/W	2700K	ø18x64mm

NEW



LED SPOTLIGHT G9
Plastic

Socket	G9	CRI	Ra>80
Input Voltage	220-240V 50/60Hz	IP Rating	IP20
Beam Angle	360°	Dimmable	No

SKU	Watt	Lumen	Lumen/W	Color	Dimension
1647	7W	820lm	117lm/W	2800K	ø19x68mm
1648	7W	950lm	135lm/W	2800K	ø19x68mm





5 Years Warranty

LED SPOTLIGHT MR16					
PREMIUM LINE					
SMD					
Socket	GU5.3/MR16	CRI	Ra>80		
Input Voltage	AC / DC12V	IP Rating	IP20		
Beam Angle	110°	Dimmable	No		
SKU	Watt	Lumen	Lumen/W	Color	Dimension
1761	5W	400lm	80lm/W	6000K	ø50x54mm
1762	5W	400lm	80lm/W	4500K	ø50x54mm
1763	5W	400lm	80lm/W	2800K	ø50x54mm
1764	7W	600lm	86lm/W	6000K	ø50x54mm
1765	7W	600lm	86lm/W	4500K	ø50x54mm
1766	7W	600lm	86lm/W	2800K	ø50x54mm



5 Years Warranty

LED SPOTLIGHT GU10					
PREMIUM LINE					
SMD					
Socket	Gu10	CRI	Ra>80		
Input Voltage	AC175-265V 50Hz	IP Rating	IP20		
Beam Angle	110°	Dimmable	No		
SKU	Watt	Lumen	Lumen/W	Color	Dimension
1767	5W	400lm	80lm/W	6000K	ø50x57mm
1768	5W	400lm	80lm/W	4500K	ø50x57mm
1769	5W	400lm	80lm/W	2700K	ø50x57mm
1772	7W	600lm	86lm/W	6000K	ø50x57mm
1770	7W	600lm	86lm/W	4500K	ø50x57mm
1773	7W	600lm	86lm/W	2700K	ø50x57mm



LED SPOTLIGHT MR16					
SMD					
Socket	GU5.3/MR16	CRI	Ra>80		
Input Voltage	AC / DC12V	IP Rating	IP20		
Beam Angle	110°	Dimmable	No		
SKU	Watt	Lumen	Lumen/W	Color	Dimension
1191	5W	400lm	73lm/W	6000K	ø50x47mm
1192	5W	400lm	73lm/W	4500K	ø50x47mm
1193	5W	400lm	73lm/W	2700K	ø50x47mm
1194	7W	600lm	84lm/W	6000K	ø50x47mm
1195	7W	600lm	84lm/W	4000K	ø50x47mm
1196	7W	600lm	84lm/W	2700K	ø50x47mm

NEW



0-100% Dimming

LED SPOTLIGHT GU10					
6W Glass -Vintage -Premium Dimming					
Socket	GU10	CRI	Ra>80		
Input Voltage	220-240V 50/60Hz	IP Rating	IP20		
Beam Angle	360°	Dimmable	YES		
SKU	Watt	Lumen	Lumen/W	Color	Dimension
1925	6W	700lm	117lm/W	6000K	ø50x55mm
1926	6W	700lm	117lm/W	4500K	ø50x55mm
1927	6W	700lm	117lm/W	2800K	ø50x55mm



LED SPOTLIGHT MR16					
COB					
Socket	GU5.3/MR16	CRI	Ra>80		
Input Voltage	AC / DC12V	IP Rating	IP20		
Beam Angle	50°	Dimmable	No		
SKU	Watt	Lumen	Lumen/W	Color	Dimension
1164	4W	320lm	80lm/W	6000K	ø50x50mm
1168	6W	400lm	67lm/W	6000K	ø50x55mm
1169	6W	400lm	67lm/W	4000K	ø50x55mm
1170	6W	400lm	67lm/W	2700K	ø50x55mm

NEW



LED SPOTLIGHT GU11					
2W SMD					
Socket	GU10	CRI	Ra>80		
Input Voltage	220-240V 50/60Hz	IP Rating	IP20		
Beam Angle	110°	Dimmable	No		
SKU	Watt	Lumen	Lumen/W	Color	Dimension
1981	2W	120lm	60lm/W	6000K	ø35x46mm
1982	2W	120lm	60lm/W	4500K	ø35x46mm
1983	2W	120lm	60lm/W	2700K	ø35x46mm



LED SPOTLIGHT GU10

SMD

Input Voltage	AC175-265V 50Hz
Beam Angle	110°
CRI	Ra>80
IP Rating	IP20
Dimmable	No

SKU	Watt	Lumen	Lumen/W	Color	Dimension
1901	4.5W	320lm	71lm/W	6000K	ø50x57mm
1902	4.5W	320lm	71lm/W	4500K	ø50x57mm
1903	4.5W	320lm	71lm/W	2700K	ø50x57mm
1904	6.5W	550lm	71lm/W	6000K	ø50x57mm
1905	6.5W	550lm	71lm/W	4500K	ø50x57mm
1906	6.5W	550lm	71lm/W	2700K	ø50x57mm
1907	9.5W	880lm	93lm/W	6000K	ø50x57mm
1908	9.5W	880lm	93lm/W	4500K	ø50x57mm
1909	9.5W	880lm	93lm/W	2700K	ø50x57mm
1945	7W	500lm	72lm/W	6000K	ø50x57mm
1946	7W	500lm	72lm/W	4500K	ø50x57mm
1947	7W	500lm	72lm/W	2700K	ø50x57mm

Dimmable



LED SPOTLIGHT GU10

COB -WHITE

Input Voltage	AC220-240V 50Hz
Beam Angle	50°
CRI	Ra>80
IP Rating	IP20
Dimmable	No

SKU	Watt	Lumen	Lumen/W	Color	Dimension
1957	4W	320lm	80lm/W	6000K	ø50x55mm
1958	4W	320lm	80lm/W	4500K	ø50x55mm
1959	4W	320lm	80lm/W	2700K	ø50x55mm
1960	6W	480lm	80lm/W	6000K	ø50x55mm
1961	6W	480lm	80lm/W	4500K	ø50x55mm
1962	6W	480lm	80lm/W	2700K	ø50x55mm
1963	6W	500lm	83lm/W	6000K	ø50x55mm
1964	6W	500lm	83lm/W	4500K	ø50x55mm

Dimmable



LED SPOTLIGHT GU10

SMD

Input Voltage	AC175-265V 50Hz
Beam Angle	38°
CRI	Ra>80
IP Rating	IP20
Dimmable	No

SKU	Watt	Lumen	Lumen/W	Color	Dimension
1935	5W	400lm	80lm/W	6000K	ø50x57mm
1936	5W	400lm	80lm/W	4500K	ø50x57mm
1937	5W	400lm	80lm/W	2700K	ø50x57mm
1938	7W	560lm	80lm/W	6000K	ø50x57mm
1939	7W	560lm	80lm/W	4500K	ø50x57mm
1940	7W	560lm	80lm/W	2700K	ø50x57mm
1944	7W	500lm	72lm/W	4500K	ø50x57mm

Dimmable



LED SPOTLIGHT GU10

COB -Silver

Input Voltage	AC220-265V 50Hz
Beam Angle	50°
CRI	Ra>80
IP Rating	IP20
Dimmable	No

SKU	Watt	Lumen	Lumen/W	Color	Dimension
1263	4W	320lm	80lm/W	6000K	ø50x60mm
1265	4W	320lm	80lm/W	2700K	ø50x60mm
1266	4W	320lm	80lm/W	6000K	ø50x60mm
1267	4W	320lm	80lm/W	4500K	ø50x60mm
1269	6W	480lm	80lm/W	6000K	ø50x60mm
1270	6W	480lm	80lm/W	4500K	ø50x60mm
1271	6W	480lm	80lm/W	2700K	ø50x60mm
1272	6W	480lm	80lm/W	6000K	ø50x60mm
1273	6W	480lm	80lm/W	4500K	ø50x60mm

Dimmable

Dimmable



LED SPOTLIGHT GU10					
AR111					
Socket	GU10		CRI	Ra>80	
Input Voltage	AC170-265V 50Hz		IP Rating	IP20	
Beam Angle	30°		Dimmable	No	
SKU	Watt	Lumen	Lumen/W	Color	Dimension
1533	15W	1200lm	80lm/W	4500K	ø111x58mm
1534	15W	1200lm	80lm/W	2700K	ø111x58mm
1535	15W	1100lm	84lm/W	4500K	ø111x58mm
1536	15W	1100lm	84lm/W	2700K	ø111x58mm

Dimmable



EPISTAR
CHIPS

LED SPOTLIGHT AR111					
G53					
Socket	G53		CRI	Ra>80	
Input Voltage	DC 12V		IP Rating	IP20	
Beam Angle	30°		Dimmable	No	
SKU	Watt	Lumen	Lumen/W	Color	Dimension
1527	12W	960lm	80lm/W	4500K	ø111x58mm
1517	15W	1080lm	70lm/W	4500K	ø111x58mm
1516	15W	1080lm	70lm/W	2700K	ø111x58mm



LED SPOTLIGHT GU10					
AR111 -Plastic					
Socket	GU10		CRI	Ra>80	
Input Voltage	AC170-265V 50Hz		IP Rating	IP20	
Beam Angle	120°		Dimmable	No	
SKU	Watt	Lumen	Lumen/W	Color	Dimension
1531	9W	820lm	91lm/W	4500K	ø111x58mm
1532	9W	820lm	91lm/W	2700K	ø111x58mm



EPISTAR
CHIPS

LED SPOTLIGHT AR111					
G53					
Socket	G53		CRI	Ra>80	
Input Voltage	DC 12V		IP Rating	IP20	
Beam Angle	120°		Dimmable	No	
SKU	Watt	Lumen	Lumen/W	Color	Dimension
1519	15W	1050lm	70lm/W	4500K	ø111x58mm
1518	15W	1050lm	70lm/W	2700K	ø111x58mm



LED SPOTLIGHT GX53					
7W Recessed					
Socket	GX53		CRI	Ra>80	
Input Voltage	220-240V 50/60Hz		IP Rating	IP20	
Beam Angle	180°		Dimmable	No	
SKU	Watt	Lumen	Lumen/W	Color	Dimension
1541	7W	560lm	80lm/W	6000K	ø74x25mm
1542	7W	560lm	80lm/W	4500K	ø74x25mm
1543	7W	560lm	80lm/W	2700K	ø74x25mm



LED SPOTLIGHT PAR30					
E27 -Black					
Socket	E27		CRI	Ra>80	
Input Voltage	AC220-240V 50Hz		IP Rating	IP20	
Beam Angle	30°		Dimmable	No	
SKU	Watt	Lumen	Lumen/W	Color	Dimension
1528	25W	2400lm	96lm/W	6000K	ø95x130mm
1529	25W	2400lm	96lm/W	4500K	ø95x130mm
1530	25W	2400lm	96lm/W	2700K	ø95x130mm



LED BULB A60	
PREMIUM LINE	
E27	
Input Voltage	AC175-265V 50Hz
Beam Angle	270°
CRI	Ra>80
IP Rating	IP20
Dimmable	No

SKU	Watt	Lumen	Lumen/W	Color	Dimension
1718	10W	950lm	95lm/W	6000K	ø60x109mm
1719	10W	950lm	95lm/W	4500K	ø60x109mm
1720	10W	950lm	95lm/W	2700K	ø60x109mm
1721	12W	1155lm	96lm/W	6000K	ø60x112mm
1722	12W	1155lm	96lm/W	4500K	ø60x112mm
1723	12W	1155lm	96lm/W	2700K	ø60x112mm
1724	15W	1320lm	88lm/W	6000K	ø60x120mm
1725	15W	1320lm	88lm/W	4500K	ø60x120mm
1726	15W	1320lm	88lm/W	2700K	ø60x120mm
1748	18W	1880lm	104lm/W	6000K	ø70x120mm
1749	18W	1880lm	104lm/W	4500K	ø70x120mm
1750	18W	1880lm	104lm/W	2700K	ø70x120mm

A70



LED BULB A60	
E27 -Dimmable	
Input Voltage	AC220-240V 50Hz
Beam Angle	270°
CRI	Ra>80
IP Rating	IP20
Dimmable	Yes

SKU	Watt	Lumen	Lumen/W	Color	Dimension
1701	9W	806lm	90lm/W	6000K	ø60x108mm
1702	9W	806lm	90lm/W	4500K	ø60x108mm
1703	9W	806lm	90lm/W	2700K	ø60x108mm
1849	10W	1055lm	101lm/W	6000K	ø60x110mm
1704	11W	1055lm	96lm/W	6000K	ø60x118mm
1705	11W	1055lm	96lm/W	4500K	ø60x118mm
1706	11W	1055lm	96lm/W	2700K	ø60x118mm



LED BULB A60	
E27	
Input Voltage	AC220-240V 50Hz
Beam Angle	270°
CRI	Ra>80
IP Rating	IP20
Dimmable	No

SKU	Watt	Lumen	Lumen/W	Color	Dimension
1351	8.5W	806lm	95lm/W	6000K	ø60x108mm
1352	8.5W	806lm	95lm/W	4500K	ø60x108mm
1353	8.5W	806lm	95lm/W	2700K	ø60x108mm
1354	10.5W	1055lm	101lm/W	6000K	ø60x108mm
1355	10.5W	1055lm	101lm/W	4500K	ø60x108mm
1356	10.5W	1055lm	101lm/W	2700K	ø60x108mm
1357	14W	1380lm	99lm/W	6000K	ø60x118mm
1358	14W	1380lm	99lm/W	4500K	ø60x118mm
1359	14W	1320lm	99lm/W	2700K	ø60x118mm
1360	17W	1710lm	101lm/W	6000K	ø65x125mm
1361	17W	1710lm	101lm/W	4500K	ø65x125mm
1362	17W	1710lm	101lm/W	2700K	ø65x125mm
1363	19W	1950lm	115lm/W	4500K	ø65x135mm
1364	19W	1950lm	115lm/W	2700K	ø65x135mm
1365	19W	1950lm	115lm/W	4500K	ø65x135mm

A65



LED BULB G45	
E27	
Input Voltage	AC175-265V 50Hz
Beam Angle	180°
CRI	Ra>80
IP Rating	IP20
Dimmable	No

SKU	Watt	Lumen	Lumen/W	Color	Dimension
1344	3.5W	300lm	86lm/W	6000K	ø45x75mm
1345	3.5W	300lm	86lm/W	4500K	ø45x75mm
1346	3.5W	300lm	86lm/W	2700K	ø45x75mm
1327	5.5W	450lm	82lm/W	6000K	ø45x75mm
1328	5.5W	450lm	82lm/W	4500K	ø45x75mm
1329	5.5W	450lm	82lm/W	2700K	ø45x75mm
1336	8W	710lm	89lm/W	6000K	ø45x80mm
1337	8W	710lm	89lm/W	4500K	ø45x80mm
1338	8W	710lm	89lm/W	2700K	ø45x80mm



LED BULB A60					
E27 -3 pcs Pack					
Socket	E27	CRI	Ra>80		
Input Voltage	AC220-240V 50Hz	IP Rating	IP20		
Beam Angle	270°	Dimmable	No		
SKU	Watt	Lumen	Lumen/W	Color	Dimension
1341	8.5W	806lm	95lm/W	6000K	ø60x108mm
1342	8.5W	806lm	95lm/W	4500K	ø60x108mm
1343	8.5W	806lm	95lm/W	2700K	ø60x108mm

NEW



LED BULB G46					
E27					
Socket	E27	CRI	Ra>80		
Input Voltage	AC220-240V 50Hz	IP Rating	IP20		
Beam Angle	90°	Dimmable	No		
SKU	Watt	Lumen	Lumen/W	Color	Dimension
11301	10W	1000lm	100lm/W	6000K	ø46x86mm
11302	10W	1000lm	100lm/W	4500K	ø46x86mm
11303	10W	1000lm	100lm/W	2700K	ø46x86mm



LED BULB A60					
E27 -Motion Sensor					
Socket	E27	CRI	Ra>80		
Input Voltage	AC220-240V 50Hz	IP Rating	IP20		
Beam Angle	270°	Dimmable	No		
SKU	Watt	Lumen	Lumen/W	Color	Dimension
1710	7W	560lm	95lm/W	6000K	ø60x123mm
1711	7W	560lm	95lm/W	4500K	ø60x123mm

NEW



LED BULBS CCT					
E27					
Socket	E27	CRI	Ra>80		
Input Voltage	AC220-240V 50Hz	IP Rating	IP20		
Beam Angle	270°	Dimmable	No		
SKU	Watt	Lumen	Lumen/W	Color	Dimension
11304	10W	1000lm	100lm/W	CCT	ø60x150 mm



LED BULB A63					
E27					
Socket	E27	CRI	Ra>80		
Input Voltage	AC220-240V 50Hz	IP Rating	IP20		
Beam Angle	270°	Dimmable	No		
SKU	Watt	Lumen	Lumen/W	Color	Dimension
1876	6W	480lm	80lm/W	6000K	ø63x100mm
1877	6W	480lm	80lm/W	4500K	ø63x100mm
1878	6W	480lm	80lm/W	2700K	ø63x100mm

NEW



LED BULBS 2835SMD					
E27					
Socket	E27	CRI	Ra>80		
Input Voltage	AC110-240V 50Hz	IP Rating	IP20		
Beam Angle	270°	Dimmable	No		
SKU	Watt	Lumen	Lumen/W	Color	Dimension
11311	12W	1550lm	130lm/W	2700K	ø28x115 mm



LED BULBS G95 /G120

E27

Input Voltage	AC175-265V 50Hz
Beam Angle	270°
CRI	Ra>80
IP Rating	IP20
Dimmable	No

SKU	Watt	Lumen	Lumen/W	Color	Dimension
1841	12W	1155lm	96lm/W	6000K	ø95x138mm
1842	12W	1155lm	96lm/W	4500K	ø95x138mm
1843	12W	1155lm	96lm/W	2700K	ø95x138mm
1845	15W	1500lm	100lm/W	6000K	ø120x155mm
1846	15W	1500lm	100lm/W	4500K	ø120x155mm
1847	15W	1500lm	100lm/W	2700K	ø120x155mm
1884	18W	1820lm	101lm/W	6000K	ø120x172mm
1885	18W	1820lm	101lm/W	4500K	ø120x172mm
1886	18W	1820lm	101lm/W	2700K	ø120x172mm

G120



LED CANDLE C37

E14

Input Voltage	AC175-265V 50Hz
Beam Angle	180°
CRI	Ra>80
IP Rating	IP20
Dimmable	No

SKU	Watt	Lumen	Lumen/W	Color	Dimension
1422	3.7W	320lm	86lm/W	6000K	ø37x100mm
1423	3.7W	320lm	86lm/W	4500K	ø37x100mm
1424	3.7W	320lm	86lm/W	2700K	ø37x100mm
1425	5.5W	450lm	82lm/W	6000K	ø37x100mm
1426	5.5W	450lm	82lm/W	4500K	ø37x100mm
1427	5.5W	450lm	82lm/W	2700K	ø37x100mm
1428	8W	710lm	89lm/W	6000K	ø37x112mm
1429	8W	710lm	89lm/W	4500K	ø37x112mm
1430	8W	710lm	89lm/W	2700K	ø37x112mm

NEW



LED BULBS T80-T120

E27

Input Voltage	AC220-240V 50Hz
Beam Angle	150°
CRI	Ra>80
IP Rating	IP20
Dimmable	No

SKU	Watt	Lumen	Lumen/W	Color	Dimension
11891	25W	2700lm	108lm/W	6000K	ø80x138mm
11892	25W	2700lm	108lm/W	4000K	ø80x138mm
11893	30W	3200lm	106lm/W	6000K	ø100x165mm
11894	30W	3200lm	106lm/W	4000K	ø100x165mm
11895	40W	4000lm	100lm/W	6000K	ø120x191mm
11896	40W	4000lm	100lm/W	4000K	ø120x191mm
11897	50W	5000lm	100lm/W	6000K	ø140x220mm
11898	50W	5000lm	100lm/W	4000K	ø150x220mm

T80

T100

T120

T140



LED BULB G45

E14

Input Voltage	AC175-265V 50Hz
Beam Angle	240°
CRI	Ra>80
IP Rating	IP20
Dimmable	No

SKU	Watt	Lumen	Lumen/W	Color	Dimension
1407	3.5W	300lm	86lm/W	6000K	ø45x78mm
1408	3.5W	300lm	86lm/W	4500K	ø45x78mm
1409	3.5W	300lm	86lm/W	2700K	ø45x78mm
1401	5.5W	450lm	82lm/W	6000K	ø45x78mm
1402	5.5W	450lm	82lm/W	4500K	ø45x78mm
1403	5.5W	450lm	82lm/W	2700K	ø45x78mm
1404	8W	710lm	89lm/W	6000K	ø45x80mm
1405	8W	710lm	89lm/W	4500K	ø45x80mm
1406	8W	710lm	89lm/W	2700K	ø45x80mm

NEW



LED BULB C38					
E14					
Socket	E14		CRI	Ra>80	
Input Voltage	AC220-240V 50Hz		IP Rating	IP20	
Beam Angle	90°		Dimmable	No	
SKU	Watt	Lumen	Lumen/W	Color	Dimension
11401	10W	1000lm	100lm/W	6000K	ø38x116mm
11402	10W	1000lm	100lm/W	4500K	ø38x116mm
11403	10W	1000lm	100lm/W	2700K	ø38x116mm

NEW



LED BULB G46					
E14					
Socket	E14		CRI	Ra>80	
Input Voltage	AC220-240V 50Hz		IP Rating	IP20	
Beam Angle	180°		Dimmable	No	
SKU	Watt	Lumen	Lumen/W	Color	Dimension
11404	10W	1000lm	100lm/W	6000K	ø46x86mm
11405	10W	1000lm	100lm/W	4500K	ø46x86mm
11406	10W	1000lm	100lm/W	2700K	ø46x86mm

LED CANDLE C37					
E14 -Dimmable					
Socket	E14		CRI	Ra>80	
Input Voltage	AC175-265V 50Hz		IP Rating	IP20	
Beam Angle	180°		Dimmable	Yes	
SKU	Watt	Lumen	Lumen/W	Color	Dimension
1464	6W	480lm	80lm/W	6000K	ø37x100mm
1465	6W	480lm	80lm/W	4500K	ø37x100mm
1463	6W	480lm	80lm/W	2700K	ø37x100mm

LED CANDLE C37 -TIP					
E14					
Socket	E14		CRI	Ra>80	
Input Voltage	AC175-265V 50Hz		IP Rating	IP20	
Beam Angle	270°		Dimmable	No	
SKU	Watt	Lumen	Lumen/W	Color	Dimension
1435	5.5W	450lm	82lm/W	6000K	ø37x125mm
1436	5.5W	450lm	82lm/W	4500K	ø37x125mm
1437	5.5W	450lm	82lm/W	2700K	ø37x125mm



LED BULB R39					
E14					
Socket	E14		CRI	Ra>80	
Input Voltage	AC175-265V 50Hz		IP Rating	IP20	
Beam Angle	200°		Dimmable	No	
SKU	Watt	Lumen	Lumen/W	Color	Dimension
1487	4W	300lm	75lm/W	6000K	ø39x70mm
1488	4W	300lm	75lm/W	4500K	ø39x70mm
1489	4W	300lm	75lm/W	2700K	ø39x70mm



LED BULB R50					
E14					
Socket	E14		CRI	Ra>80	
Input Voltage	AC175-265V 50Hz		IP Rating	IP20	
Beam Angle	180°		Dimmable	No	
SKU	Watt	Lumen	Lumen/W	Color	Dimension
1438	6W	450lm	75lm/W	6000K	ø50x85mm
1439	6W	450lm	75lm/W	4500K	ø50x85mm
1440	6W	450lm	75lm/W	2700K	ø50x85mm



LED Spotlight E14					
E14SMD					
Socket	E14		CRI	Ra>80	
Input Voltage	AC220-240V 50Hz		IP Rating	IP20	
Beam Angle	360°		Dimmable	No	
SKU	Watt	Lumen	Lumen/W	Color	Dimension
1499	7W	820lm	117lm/W	4500K	ø19x71mm



LED BULB FILAMENT R50					
E14					
Socket	E14		CRI	Ra>80	
Input Voltage	AC175-265V 50Hz		IP Rating	IP20	
Beam Angle	150°		Dimmable	No	
SKU	Watt	Lumen	Lumen/W	Color	Dimension
1872	5W	600lm	120lm/W	2700K	ø50x86mm





LED FILAMENT DESIGNER BULBS					
E27 -Golden Glass					
Socket	E27	CRI	Ra>80		
Input Voltage	AC180-240V 50Hz	IP Rating	IP20		
Beam Angle	300°	Dimmable	No		
SKU	Watt	Lumen	Body	Color	Dimension
11701	2.5W	188lm	Black	1800K	ø148x175mm
11702	2.5W	188lm	Copper	1800K	ø148x175mm



LED FILAMENT DESIGNER BULBS					
E27 -Golden Glass					
Socket	E27	CRI	Ra>80		
Input Voltage	AC180-240V 50Hz	IP Rating	IP20		
Beam Angle	300°	Dimmable	No		
SKU	Watt	Lumen	Lumen/W	Color	Dimension
11709	3W	225lm	75lm/W	1800K	ø45x165mm



LED FILAMENT DESIGNER BULBS					
E27 -Golden Glass					
Socket	E27	CRI	Ra>80		
Input Voltage	AC180-240V 50Hz	IP Rating	IP20		
Beam Angle	300°	Dimmable	No		
SKU	Watt	Lumen	Body	Color	Dimension
11703	2.5W	188lm	Black	1800K	ø148x240mm
11704	2.5W	188lm	Copper	1800K	ø148x240mm



LED FILAMENT DESIGNER BULBS					
E27 -Golden Glass					
Socket	E27	CRI	Ra>80		
Input Voltage	AC180-240V 50Hz	IP Rating	IP20		
Beam Angle	300°	Dimmable	No		
SKU	Watt	Lumen	Lumen/W	Color	Dimension
11710	3W	225lm	75lm/W	1800K	ø125x165mm



LED FILAMENT DESIGNER BULBS					
E27 -Golden Glass					
Socket	E27	CRI	Ra>80		
Input Voltage	AC180-240V 50Hz	IP Rating	IP20		
Beam Angle	300°	Dimmable	No		
SKU	Watt	Lumen	Body	Color	Dimension
11705	2.5W	188lm	Black	1800K	ø200x180mm
11706	2.5W	188lm	Copper	1800K	ø200x180mm



LED FILAMENT DESIGNER BULBS					
E27 -Golden Glass					
Socket	E27	CRI	Ra>80		
Input Voltage	AC180-240V 50Hz	IP Rating	IP20		
Beam Angle	300°	Dimmable	No		
SKU	Watt	Lumen	Lumen/W	Color	Dimension
11711	3W	225lm	75lm/W	1800K	ø137x220mm



LED FILAMENT DESIGNER BULBS					
E27 -Golden Glass					
Socket	E27	CRI	Ra>80		
Input Voltage	AC180-240V 50Hz	IP Rating	IP20		
Beam Angle	300°	Dimmable	No		
SKU	Watt	Lumen	Body	Color	Dimension
11707	2.5W	188lm	Black	1800K	ø125x150mm
11708	2.5W	188lm	Copper	1800K	ø125x150mm



LED FILAMENT DESIGNER BULBS					
E27 -Golden Glass					
Socket	E27	CRI	Ra>80		
Input Voltage	AC180-240V 50Hz	IP Rating	IP20		
Beam Angle	300°	Dimmable	No		
SKU	Watt	Lumen	Lumen/W	Color	Dimension
11712	3W	225lm	75lm/W	1800K	ø132x252mm



LED BULB FILAMENT G95					
E27 -Half Golden Glass					
Socket	E27	CRI	Ra>80		
Input Voltage	AC175-265V 50Hz	IP Rating	IP20		
Beam Angle	180°	Dimmable	No		
SKU	Watt	Lumen	Lumen/W	Color	Dimension
1889	4W	400lm	100lm/W	2700K	ø95x140mm
1890	7W	800lm	114lm/W	2700K	ø95x140mm



LEDBULB FILAMENT PS160					
E27 -Golden Glass					
Socket	E27	CRI	Ra>80		
Input Voltage	AC175-265V 50Hz	IP Rating	IP20		
Beam Angle	270°	Dimmable	Yes		
SKU	Watt	Lumen	Lumen/W	Color	Dimension
1790	8W	810lm	101lm/W	2700K	ø95x140mm



LED BULB FILAMENT G95					
E27 -Half Silver Glass					
Socket	E27	CRI	Ra>80		
Input Voltage	AC175-265V 50Hz	IP Rating	IP20		
Beam Angle	180°	Dimmable	No		
SKU	Watt	Lumen	Lumen/W	Color	Dimension
1887	4W	400lm	100lm/W	2700K	ø95x140mm
1888	7W	800lm	114lm/W	2700K	ø95x140mm



LED BULB FILAMENT BD200					
E27 -Golden Glass					
Socket	E27	CRI	Ra>80		
Input Voltage	AC175-265V 50Hz	IP Rating	IP20		
Beam Angle	270°	Dimmable	Yes		
SKU	Watt	Lumen	Lumen/W	Color	Dimension
1791	8W	810lm	101lm/W	2700K	ø95x140mm



LED BULB FILAMENT A60					
E27 -Half Golden Glass					
Socket	E27	CRI	Ra>80		
Input Voltage	AC175-265V 50Hz	IP Rating	IP20		
Beam Angle	180°	Dimmable	No		
SKU	Watt	Lumen	Lumen/W	Color	Dimension
1893	4W	400lm	100lm/W	2700K	ø60x105mm
1896	7W	800lm	114lm/W	2700K	ø60x105mm



LED BULB FILAMENT G200					
E27 -Golden Glass					
Socket	E27	CRI	Ra>80		
Input Voltage	AC175-265V 50Hz	IP Rating	IP20		
Beam Angle	270°	Dimmable	Yes		
SKU	Watt	Lumen	Lumen/W	Color	Dimension
1792	8W	810lm	101lm/W	2700K	ø60x105mm



LED BULB FILAMENT A60					
E27 -Half Silver Glass					
Socket	E27	CRI	Ra>80		
Input Voltage	AC175-265V 50Hz	IP Rating	IP20		
Beam Angle	180°	Dimmable	No		
SKU	Watt	Lumen	Lumen/W	Color	Dimension
1879	4W	400lm	100lm/W	2700K	ø60x105mm
1880	7W	800lm	140lm/W	2700K	ø60x105mm



LED BULB FILAMENT MS200					
E27 -Golden Glass					
Socket	E27	CRI	Ra>80		
Input Voltage	AC175-265V 50Hz	IP Rating	IP20		
Beam Angle	270°	Dimmable	Yes		
SKU	Watt	Lumen	Lumen/W	Color	Dimension
1793	8W	810lm	101lm/W	2700K	ø60x105mm



LED FILAMENT BULB A60

E27	
Input Voltage	AC175-265V 50Hz
Beam Angle	300°
CRI	Ra>80
IP Rating	IP20
Dimmable	No



SKU	Watt	Lumen	Lumen/W	Color	Dimension
1857	4W	400lm	100lm/W	6000K	ø60x106mm
1858	4W	400lm	100lm/W	4500K	ø60x106mm
1859	4W	400lm	100lm/W	2700K	ø60x106mm
1899	4W	470lm	117lm/W	2700K	ø60x106mm
1854	5W	600lm	120lm/W	6000K	ø37x100mm
1855	5W	600lm	120lm/W	4500K	ø60x106mm
1856	5W	600lm	120lm/W	2700K	ø60x106mm
1308	6W	630lm	105lm/W	4000K	ø60x105mm
1309	6W	630lm	105lm/W	2700K	ø60x105mm
1853	6W	630lm	105lm/W	2700K	ø60x105mm
1310	8W	810lm	101lm/W	6000K	ø60x110mm
1311	8W	810lm	101lm/W	4500K	ø60x110mm
1312	8W	810lm	101lm/W	2700K	ø60x110mm
1323	8W	810lm	101lm/W	2700K	ø60x110mm



LED FILAMENT BULB A60

E27	
Input Voltage	AC220-240V 50Hz
Beam Angle	300°
CRI	Ra>80
IP Rating	IP20
Dimmable	No

A65

SKU	Watt	Lumen	Lumen/W	Color	Dimension
1313	10W	1350lm	135lm/W	6000K	ø60x110mm
1314	10W	1350lm	135lm/W	4500K	ø60x110mm
1315	10W	1350lm	135lm/W	2700K	ø60x110mm
1316	12W	1500lm	125lm/W	2700K	ø60x126mm
1317	12W	1500lm	125lm/W	6000K	ø60x126mm
1318	12W	1500lm	125lm/W	4500K	ø60x126mm
1319	14W	2000lm	143lm/W	2700K	ø65x126mm
1320	14W	2000lm	143lm/W	4000K	ø65x126mm
1321	14W	2000lm	143lm/W	2700K	ø65x126mm

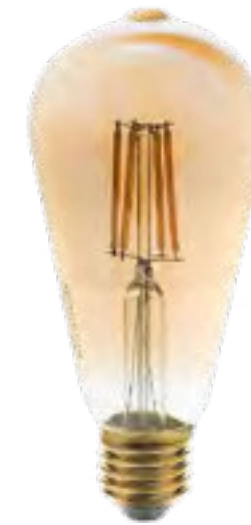

LED BULB FILAMENT ST64

E27 -Golden Glass			
Socket	E27	CRI	Ra>80
Input Voltage	AC220-240V 50Hz	IP Rating	IP20
Beam Angle	270°	Dimmable	No



SKU	Watt	Lumen	Lumen/W	Color	Dimension
1795	4W	400lm	100lm/W	2500K	ø64x140mm
1306	6W	540lm	90lm/W	2500K	ø64x140mm
1305	8W	700lm	80lm/W	2500K	ø64x140mm
1322	8W	700lm	80lm/W	2500K	ø64x140mm

LED BULB FILAMENT A60

E27 -Golden Glass			
Socket	E27	CRI	Ra>80
Input Voltage	AC220-240V 50Hz	IP Rating	IP20
Beam Angle	300°	Dimmable	No



SKU	Watt	Lumen	Lumen/W	Color	Dimension
1796	8W	700lm	88lm/W	2500K	ø64x140mm
1324	8W	720lm	90lm/W	2500K	ø64x140mm

LED BULB FILAMENT G95

E27 -Golden Glass			
Socket	E27	CRI	Ra>80
Input Voltage	AC220-240V 50Hz	IP Rating	IP20
Beam Angle	270°	Dimmable	No

SKU	Watt	Lumen	Lumen/W	Color	Dimension
1794	4W	400lm	100lm/W	2500K	ø95x135mm





LED BULB FILAMENT G125					
E27					
Socket	E27		CRI	Ra>80	
Input Voltage	AC175-265V 50Hz		IP Rating	IP20	
Beam Angle	300°		Dimmable	No	
SKU	Watt	Lumen	Lumen/W	Color	Dimension
1863	4W	400lm	100lm/W	4500K	ø125x165mm
1862	4W	400lm	100lm/W	2700K	ø125x165mm
1861	6.5W	810lm	125lm/W	4500K	ø125x165mm
1860	6.5W	810lm	125lm/W	2700K	ø125x165mm



LED BULB FILAMENT G45					
E14 -Golden Glass					
Socket	E14		CRI	Ra>80	
Input Voltage	AC175-265V 50Hz		IP Rating	IP20	
Beam Angle	300°		Dimmable	No	
SKU	Watt	Lumen	Lumen/W	Color	Dimension
1492	4W	400lm	100lm/W	2500K	ø45x78mm
1418	4W	400lm	100lm/W	2500K	ø45x78mm



LED BULB FILAMENT G45					
E27					
Socket	E27		CRI	Ra>80	
Input Voltage	AC175-265V 50Hz		IP Rating	IP20	
Beam Angle	300°		Dimmable	No	
SKU	Watt	Lumen	Lumen/W	Color	Dimension
1864	2W	200lm	100lm/W	6000K	ø45x75mm
1865	2W	200lm	100lm/W	4500K	ø45x75mm
1866	2W	200lm	100lm/W	2700K	ø45x75mm
1867	4W	400lm	100lm/W	6000K	ø45x75mm
1868	4W	400lm	100lm/W	4500K	ø45x75mm
1869	4W	400lm	100lm/W	2700K	ø45x75mm
1325	4W	400lm	100lm/W	2700K	ø45x78mm



LED CANDLE FILAMENT C35					
E14 -Golden Glass -Tip					
Socket	E14		CRI	Ra>80	
Input Voltage	AC175-265V 50Hz		IP Rating	IP20	
Beam Angle	300°		Dimmable	No	
SKU	Watt	Lumen	Lumen/W	Color	Dimension
1491	4W	400lm	100lm/W	2500K	ø35x120mm
1416	4W	400lm	100lm/W	2500K	ø35x120mm



LED BULB FILAMENT G45					
E27 -Golden Glass					
Socket	E27		CRI	Ra>80	
Input Voltage	AC175-265V 50Hz		IP Rating	IP20	
Beam Angle	300°		Dimmable	YES	
SKU	Watt	Lumen	Lumen/W	Color	Dimension
1326	4W	320lm	100lm/W	2500K	ø95x135mm



LED BULB FILAMENT C35					
E14 -Golden Glass					
Socket	E14		CRI	Ra>80	
Input Voltage	AC175-265V 50Hz		IP Rating	IP20	
Beam Angle	300°		Dimmable	No	
SKU	Watt	Lumen	Lumen/W	Color	Dimension
1490	4W	400lm	100lm/W	2500K	ø35x98mm



LED FILAMENT CANDLE C35

E14

Input Voltage	AC175-265V 50Hz
Beam Angle	300°
CRI	Ra>80
IP Rating	IP20
Dimmable	No



SKU	Watt	Lumen	Lumen/W	Color	Dimension
1470	4W	400lm	100lm/W	6000K	ø35x98mm
1471	4W	400lm	100lm/W	4500K	ø35x98mm
1472	4W	400lm	135lm/W	2700K	ø35x98mm
1410	6W	730lm	122lm/W	6000K	ø35x98mm
1411	6W	730lm	122lm/W	4500K	ø35x98mm
1412	6W	730lm	122lm/W	2700K	ø35x98mm
1469	4W	400lm	100lm/W	4500K	ø35x98mm
1473	4W	400lm	100lm/W	2700K	ø35x98mm



LED FILAMENT BULB G45

E14

Input Voltage	AC175-265V 50Hz
Beam Angle	300°
CRI	Ra>80
IP Rating	IP20
Dimmable	No



SKU	Watt	Lumen	Lumen/W	Color	Dimension
1474	2W	200lm	100lm/W	6000K	ø45x78mm
1475	2W	200lm	100lm/W	4500K	ø45x78mm
1476	2W	200lm	100lm/W	2700K	ø45x78mm
1477	4W	400lm	100lm/W	6000K	ø45x78mm
1478	4W	400lm	100lm/W	4500K	ø45x78mm
1479	4W	400lm	100lm/W	2700K	ø45x78mm
1417	4W	400lm	100lm/W	2700K	ø45x78mm



LED FILAMENT CANDLE C35

E14 -Tip

Socket	E14	CRI	Ra>80
Input Voltage	AC175-265V 50Hz	IP Rating	IP20
Beam Angle	300°	Dimmable	No



SKU	Watt	Lumen	Lumen/W	Color	Dimension
1480	4W	400lm	100lm/W	6000K	ø35x115mm
1481	4W	400lm	100lm/W	4500K	ø35x115mm
1482	4W	400lm	100lm/W	2700K	ø35x115mm
1415	4W	400lm	100lm/W	2700K	ø35x115mm



LED CANDLE FILAMENT C35

E14 -Tip

Socket	E14	CRI	Ra>80
Input Voltage	AC175-265V 50Hz	IP Rating	IP20
Beam Angle	300°	Dimmable	No

SKU	Watt	Lumen	Lumen/W	Colour	Dimension
1414	4W	400lm	100lm/W	2500K	ø35x115mm



LED BULB FILAMENT C35

E14

Socket	E14	CRI	Ra>80
Input Voltage	AC175-265V 50Hz	IP Rating	IP20
Beam Angle	300°	Dimmable	No

SKU	Watt	Lumen	Lumen/W	Color	Dimension
1413	4W	400lm	100lm/W	2500K	ø35x98mm



LED INDUSTRIAL BULB	
40W E27	
Input Voltage	180-264V 50/60Hz
Beam Angle	270°
CRI	Ra>80
IP Rating	IP20
Dimmable	No

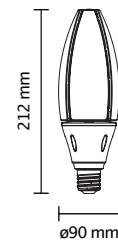

SKU	Watt	Lumen	Lumen/W	Color	Dimension
225	40W	4100lm	100lm/W	6000K	ø90x212mm
226	40W	4100lm	100lm/W	4500K	ø90x212mm



E40

LED INDUSTRIAL BULB	
50W E40	
Input Voltage	110-264V 50/60Hz
Beam Angle	270°
CRI	Ra>80
IP Rating	IP20
Dimmable	No

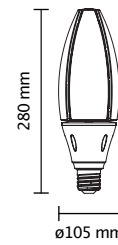

SKU	Watt	Lumen	Lumen/W	Color	Dimension
221	50W	5000lm	100lm/W	6000K	ø90x212mm



LED BULB A60
B22

Input Voltage	AC220-240V 50Hz
Beam Angle	270°
CRI	Ra>80
IP Rating	IP20
Dimmable	No

SKU	Watt	Lumen	Lumen/W	Color	Dimension
1918	9W	820lm	91lm/W	6000K	ø60x110mm
1919	9W	820lm	91lm/W	4500K	ø60x110mm
1920	9W	820lm	91lm/W	2700K	ø60x110mm
1910	10W	800lm	80lm/W	2700K	ø60x110mm
1921	11W	1055lm	96lm/W	6000K	ø60x110mm
1922	11W	1055lm	96lm/W	4500K	ø60x110mm
1923	11W	1055lm	96lm/W	2700K	ø60x110mm
1914	12W	960lm	80lm/W	2700K	ø60x105mm
1915	15W	1200lm	80lm/W	6000K	ø65x110mm
1916	15W	1200lm	80lm/W	4500K	ø65x110mm
1917	15W	1200lm	80lm/W	2700K	ø65x110mm



PORTABLE LED SOLAR BULB
Solar Panel Power: 6V 2.3W

Voltage	DC 6V	CRI	Ra>80
Flux	650lm	IP Rating	IP20
Beam Angle	360°	Body Color	White
Battery	3.2V 10Ah	Dimension	Φ110x195mm

SKU	229
Color	6000K



LED CANDLE C37
B22

Input Voltage	AC220-240V 50Hz
Beam Angle	180°
CRI	Ra>80
IP Rating	IP20
Dimmable	No

SKU	Watt	Lumen	Lumen/W	Color	Dimension
1950	6W	480lm	91lm/W	6000K	ø37x90mm
1951	6W	480lm	91lm/W	4500K	ø37x90mm
1952	6W	480lm	91lm/W	2700K	ø37x90mm
1953	6W	480lm	80lm/W	2700K	ø37x90mm



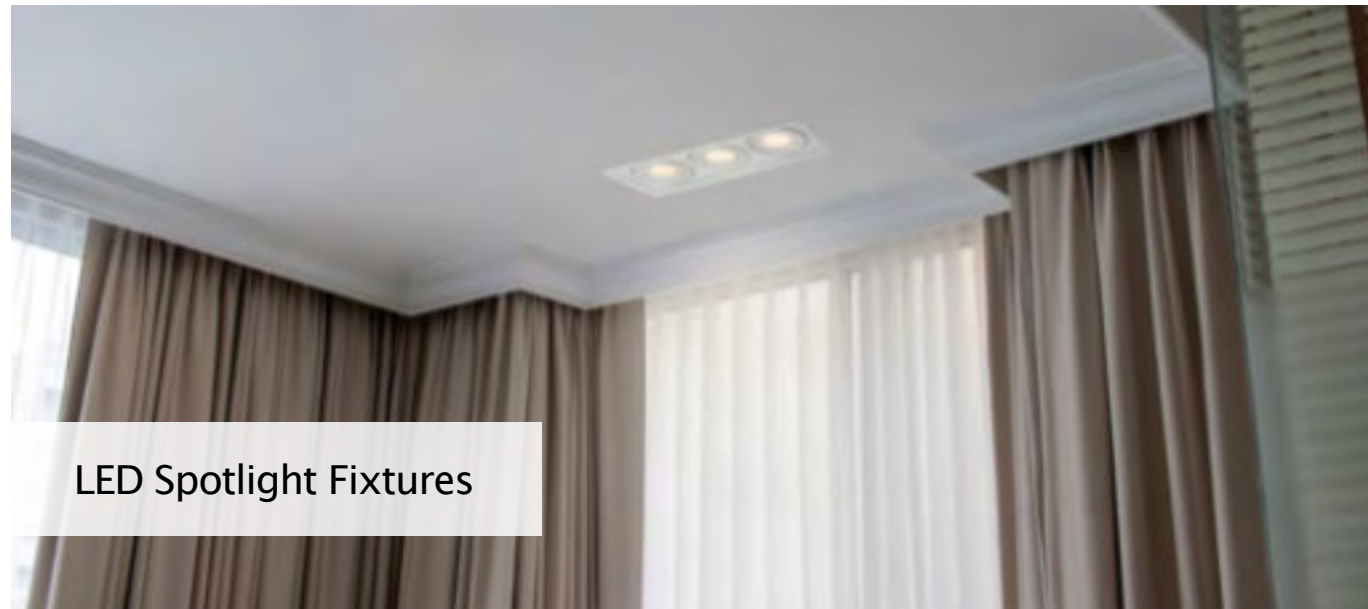

LED Spotlight Fixtures



SPOTLIGHT FIXTURE			
AR111 Fitting -Adjustable			
Socket	AR111	Material	Aluminium
Body Color	White	IP Rating	IP20

SKU	GU10 Holder	Cut Size	Dimension
5081	1xAR111	150x150mm	185x185x42mm
5083	2xAR111	300x150mm	335x185x42mm
5085	3xAR111	450x150mm	485x185x42mm

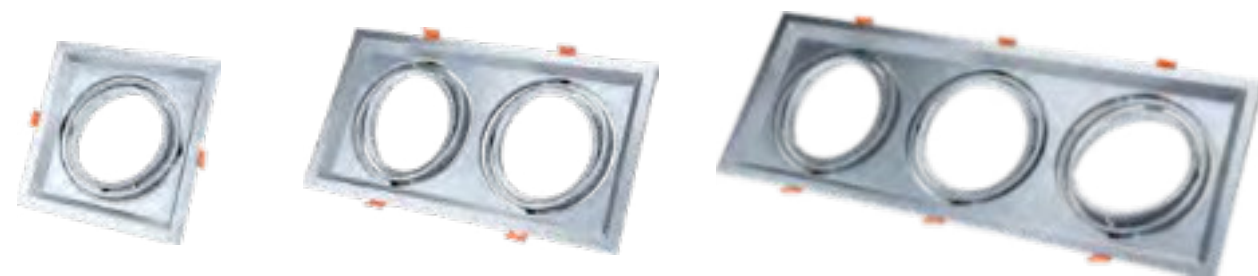

SPOTLIGHT FIXTURE			
AR111 Fitting -Adjustable			
Socket	AR111	Material	Aluminium
Body Color	Silver	IP Rating	IP20

SKU	GU10 Holder	Cut Size	Dimension
5082	1xAR111	150x150mm	185x185x42mm
5084	2xAR111	300x150mm	335x185x42mm
5086	3xAR111	450x150mm	485x185x42mm



SKU	Shape	Cut Size	Dimension
2013	Round	ø85-95mm	ø98x38mm
2014	Square	90x90mm	100x100x40mm

SPOTLIGHT FIXTURE			
GU10 Fitting -Adjustable			
Socket	GU10	Material	Aluminium
Color	White/Black	IP Rating	IP20



SKU	GU10 Holder	Cut Size	Dimension
2015	2xGU10	175x90mm	185x100x38mm
2016	3xGU10	260x90mm	270x100x38mm

SPOTLIGHT FIXTURE			
GU10 Fitting -Adjustable			
Socket	GU10	Material	Aluminium
Color	White/Black	IP Rating	IP20

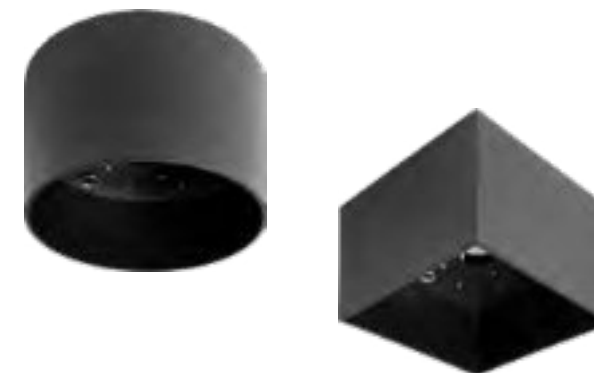

SKU	Shape	Dimension
2082	Round	ø120x80mm
2083	Square	120x120x80mm

SPOTLIGHT FIXTURE			
GU10 Fitting			
Socket	GU10	Material	Aluminium
Color	Black	IP Rating	IP20





SPOTLIGHT FIXTURE
MR16 ; GU10 Fitting -Adjustable

Material	Aluminium	IP Rating	IP20
Dimension	ø83x29mm	Cut Size	ø72mm



SKU	5170	5171	5172
Color	White	Inox	Chrome



SPOTLIGHT FIXTURE
MR16 ; GU10 Fitting

Material	Iron	IP Rating	IP20
Dimension	82x82x29mm	Cut Size	ø72mm

SKU	5073	5074	5075
Color	White	Inox	Chrome



SPOTLIGHT FIXTURE
MR16 ; GU10 Fitting -Adjustable

Material	Iron	IP Rating	IP20
Dimension	ø83x29mm	Cut Size	ø72mm



SKU	5097	5098	5099
Color	White	Inox	Chrome



SPOTLIGHT FIXTURE
MR16 ; GU10 Fitting -Adjustable

Material	Iron	IP Rating	IP20
Dimension	82x82x29mm	Cut Size	ø72mm



SKU	5076	5077	5078
Color	White	Inox	Chrome



SPOTLIGHT FIXTURE
MR16 ; GU10 Fitting

Material	Iron	IP Rating	IP20
Dimension	ø83x29mm	Cut Size	ø72mm

SKU	5070	5071	5072
Color	White	Inox	Chrome

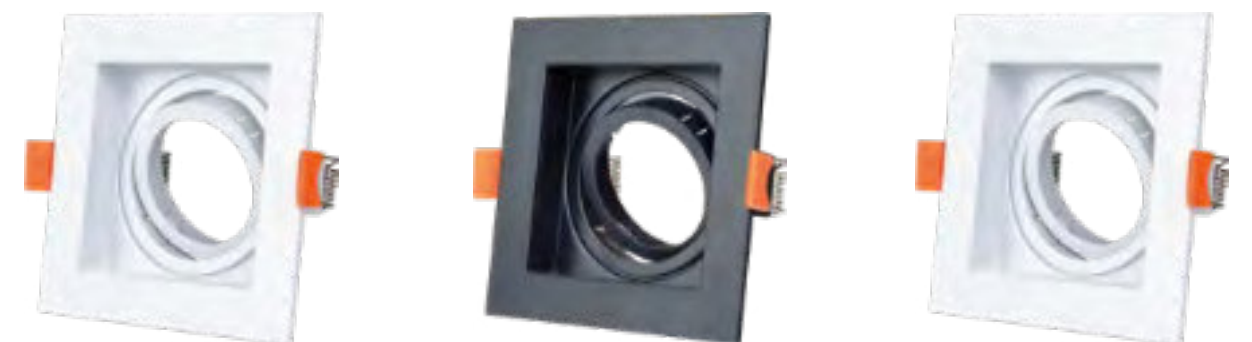

SPOTLIGHT FIXTURE
GU10 Fitting -Adjustable

Socket	GU10	Material	Plastic
Cut Size	90x90mm	Max Power	35W
Dimension	102x102x42mm	IP Rating	IP20



SKU	2050	2051	2052
Color	White	Black	White Black



SPOTLIGHT FIXTURE			
GU10 Fitting			
Socket	GU10	Material	Aluminium
Cut Size	ø70mm	Max Power	35W
Dimension	ø80x35mm	IP Rating	IP20

SKU	2047	2048	2049
Color	White	Black	Rose Gold



SPOTLIGHT FIXTURE			
GU10 Fitting -Adjustable			
Socket	GU10	Material	Alu+PC
Cut Size	ø70-80mm	Max Power	35W
Dimension	ø83x42mm	IP Rating	IP20

SKU	2031	2032	2035	2036
Color	White	Black	White	Black



SPOTLIGHT FIXTURE			
GU10 Fitting			
Socket	GU10	Material	Aluminium
Cut Size	75x75mm ; ø85mm	Max Power	35W
Dimension	75x75x55 ; ø85x50mm	IP Rating	IP20

SKU	2045	2046
Color	Square	Round



SPOTLIGHT FIXTURE			
GU10 Fitting -Adjustable			
Socket	GU10	Material	Alu+PC
Cut Size	ø70-80mm	Max Power	35W
Dimension	ø83x42mm	IP Rating	IP20

SKU	2033	2034	2037	2038
Color	White	Black	White	Black



SPOTLIGHT FIXTURE			
GU10 Fitting -Waterproof			
Socket	GU10	Material	Aluminium
Cut Size	ø70mm	Max Power	35W
Dimension	ø80x54 ; 82x82x57mm	IP Rating	IP65

SKU	Round		Square	
Color	2009	2010	2011	2012
	White	Nikel	White	Nikel





SPOTLIGHT FIXTURE			
GU10 Fitting -Trimless Recessed			
Socket	GU10	Material	Gypsum
Cut Size	ø95 ; 95x95mm	Max Power	35W
Dimension	ø100x27 ; 100x100mm	IP Rating	IP20

SKU	2060	2061
Shape	Round	Square



SPOTLIGHT FIXTURE			
GU10 Fitting -Trimless Recessed			
Socket	GU10	Material	Gypsum
Cut Size	115x115 ; 210x110mm	Max Power	35W
Dimension	120x120 ; 210x110x58mm	IP Rating	IP20

SKU	2064	2065
Socket	1xGu10	2xGu10



SPOTLIGHT FIXTURE			
GU10 Fitting -Trimless Recessed			
Socket	GU10	Material	Gypsum
Cut Size	ø125 ; 115x115mm	Max Power	35W
Dimension	ø130x50 ; 120x120mm	IP Rating	IP20

SKU	2062	2063
Shape	Round	Square



SPOTLIGHT FIXTURE			
GU10 Fitting -Trimless Recessed			
Socket	GU10	Material	Gypsum
Cut Size	115x115 ; 210x110mm	Max Power	35W
Dimension	120x120 ; 210x110x58mm	IP Rating	IP20

SKU	2066	2067
Socket	1xGu10	2xGu10



SPOTLIGHT FIXTURE			
GU10 Fitting -Trimless Recessed			
Socket	GU10	Material	Gypsum
Cut Size	ø120 ; ø130mm	Max Power	35W
Dimension	ø120 ; ø130x70mm	IP Rating	IP20

SKU	2068	2069
Shape	Round	Round





LED Spotlight Fixtures



SKU	2070	2071
Size	ø70x70mm	ø70x170mm

SPOTLIGHT FIXTURE			
GU10 Fitting			
Socket	GU10	Material	Gypsum
Input Voltage	AC220-240V 50Hz	Max Power	35W
Color	White	IP Rating	IP20



SKU	2072	2073
Size	70x70x70mm	70x70x170mm

SPOTLIGHT FIXTURE			
GU10 Fitting			
Socket	GU10	Material	Gypsum
Input Voltage	AC220-240V 50Hz	Max Power	35W
Color	White	IP Rating	IP20



SKU	2074	2075
Size	ø110x140mm	110x110x125mm

SPOTLIGHT FIXTURE			
GU10 Fitting			
Socket	GU10	Material	Gypsum
Input Voltage	AC220-240V 50Hz	Max Power	35W
Color	White	IP Rating	IP20



SKU	2042	2043	2044
Color	Black	White	Rose Gold

SPOTLIGHT FIXTURE

GU10 Fitting			
Socket	GU10	Material	Aluminium
Input Voltage	AC220-240V 50Hz	Max Power	35W
Size	ø80x140mm	IP Rating	IP20



SKU	2001	2002	2005	2006	45°
Color	White	Black	White	Black	

SPOTLIGHT FIXTURE

GU10 Fitting -Adjustable			
Socket	GU10	Material	Plastic
Input Voltage	AC220-240V 50Hz	Max Power	10W
Size	ø80x125mm	IP Rating	IP20



SKU	2039	2040	2041
Color	Black	White	Rose Gold

SPOTLIGHT FIXTURE

GU10 Fitting			
Socket	GU10	Material	Aluminium
Input Voltage	AC220-240V 50Hz	Max Power	35W
Size	75x75x140mm	IP Rating	IP20

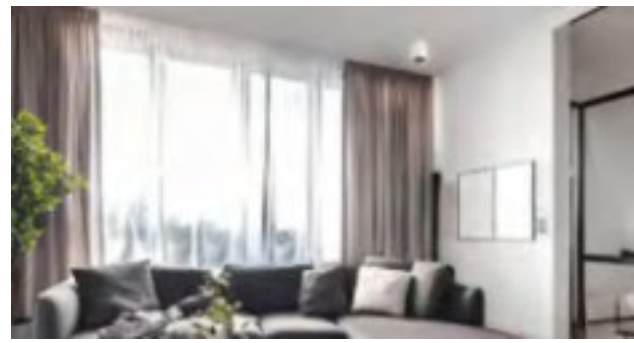

SKU	2003	2004	2007	2008	45°
Color	White	Black	White	Black	

SPOTLIGHT FIXTURE

GU10 Fitting -Adjustable			
Socket	GU10	Material	Plastic
Input Voltage	AC220-240V 50Hz	Max Power	10W
Size	85x85x130mm	IP Rating	IP20



SKU	2029	2030
Color	White	Black

SPOTLIGHT FIXTURE

GU10 Fitting			
Socket	GU10	Material	Aluminium
Input Voltage	AC220-240V 50Hz	Max Power	35W
Size	ø60x100mm	IP Rating	IP20



SKU	2027	2028
Color	White	Black

SPOTLIGHT FIXTURE

GU10 Fitting -Adjustable			
Socket	GU10	Material	Aluminium
Input Voltage	AC220-240V 50Hz	Max Power	35W
Size	ø80x42mm	IP Rating	IP20





SPOTLIGHT FIXTURE			
GU10 Fitting –Adjustable			
Socket	GU10	Material	Plastic
Input Voltage	AC220–240V 50Hz	Max Power	10W Each
Body Color	White	IP Rating	IP20

SKU	GU10 Holder	Dimension
2021	1xGU10	ø60x150mm
2023	2xGU10	ø120x150mm
2025	3xGU10	ø145x150mm



SPOTLIGHT FIXTURE			
GU10 Fitting –Adjustable			
Socket	GU10	Material	Aluminium
Input Voltage	AC220–240V 50Hz	Max Power	35W Each
Body Color	White	IP Rating	IP20

SKU	GU10 Holder	Dimension
9076	1xGU10	60x1108mm
9077	2xGU10	300x60x180mm
9078	3xGU10	540x60x180mm
9079	4xGU10	720x60x180mm



SPOTLIGHT FIXTURE			
GU10 Fitting –Adjustable			
Socket	GU10	Material	Plastic
Input Voltage	AC220–240V 50Hz	Max Power	10W Each
Body Color	Black	IP Rating	IP20

SKU	GU10 Holder	Dimension
2022	1xGU10	ø60x150mm
2024	2xGU10	ø120x150mm
2026	3xGU10	ø145x150mm



SPOTLIGHT FIXTURE			
GU10 Fitting –Adjustable			
Socket	GU10	Material	Aluminium
Input Voltage	AC220–240V 50Hz	Max Power	35W Each
Body Color	Black	IP Rating	IP20

SKU	GU10 Holder	Dimension
9072	1xGU10	60x108mm
9073	2xGU10	300x60x180mm
9074	3xGU10	540x60x180mm
9075	4xGU10	720x60x180mm



SPOTLIGHT FIXTURE			
GU10 Fitting –Adjustable			
Socket	2xGU10	Material	Aluminium
Input Voltage	AC220–240V 50Hz	Max Power	35W
Size	160x80x86mm	IP Rating	IP20



SKU	2080	2081
Color	White	Black





SKU	9063	9062	9064	9065	9066
Color	White	Black	Gold	Copper	Chrome

LED PENDANT			
GU10 Fitting			
Socket	GU10	Material	Aluminium
Input Voltage	AC220-240V 50Hz	Max Power	35W
Size	ø55x295x1000mm	IP Rating	IP20

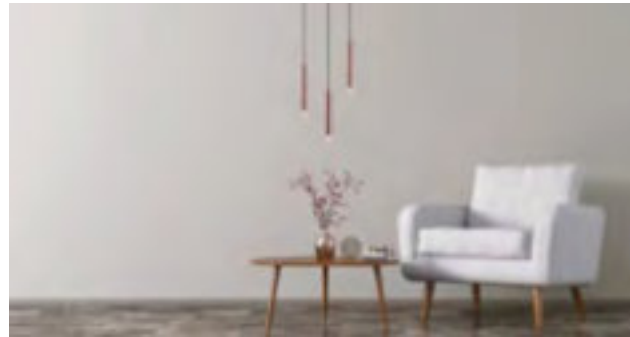

SKU	9083	9082	9080	9081
Color	White	Black	Silver	Grape Red

LED PENDANT			
GU10 Fitting			
Socket	GU10	Material	Aluminium
Input Voltage	AC220-240V 50Hz	Max Power	35W
Size	ø60x400x1200mm	IP Rating	IP20



SKU	9068	9067	9069	9070	9071
Color	White	Black	Gold	Coffee Gold	Chrome

LED PENDANT			
GU10 Fitting			
Socket	GU10	Material	Aluminium
Input Voltage	AC220-240V 50Hz	Max Power	35W
Size	ø55x295x1000mm	IP Rating	IP20



SKU	9055	9054	9051	9050
Color	White	White Gold	Black	Black Gold

LED PENDANT			
GU10 Fitting			
Socket	GU10	Material	Aluminium
Input Voltage	AC220-240V 50Hz	Max Power	35W
Size	ø60x300x1200mm	IP Rating	IP20

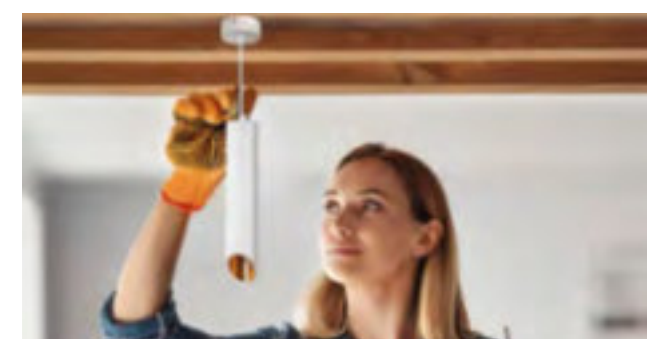

SKU	9059	9058
Color	White	Black

LED PENDANT			
GU10 Fitting			
Socket	GU10	Material	Aluminium
Input Voltage	AC220-240V 50Hz	Max Power	35W
Size	ø60x500x1200mm	IP Rating	IP20

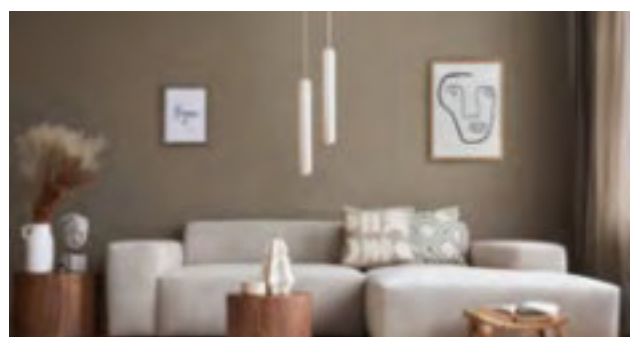

SKU	9057	9056	9053	9052
Color	White	White Gold	Black	Black Gold

LED PENDANT			
GU10 Fitting			
Socket	GU10	Material	Aluminium
Input Voltage	AC220-240V 50Hz	Max Power	35W
Size	ø60x500x1200mm	IP Rating	IP20



NEW



Included



LED PENDANT +GU10			
5W GU10 Spotlight included			
Power	5W	Material	Aluminium
Input Voltage	AC220-240V 50Hz	Beam Angle	38°
Lumen	400lm	IP Rating	IP20
Size	ø60x500x1200mm	Color	2700K



SKU	9099	9098
Color	White	Black



SKU	9085	9084	9086	9087
Color	White	Black	Gold	Rose Gold

LED PENDANT			
E27 Fitting			
Socket	E27	Material	Aluminium
Input Voltage	AC220-240V 50Hz	Max Power	35W
Size	ø40x250x1000mm	IP Rating	IP20



LED PENDANT			
GU10 Fitting			
Socket	GU10	Material	Aluminium
Input Voltage	AC220-240V 50Hz	Max Power	35W
Size	ø40x250x1000mm	IP Rating	IP20

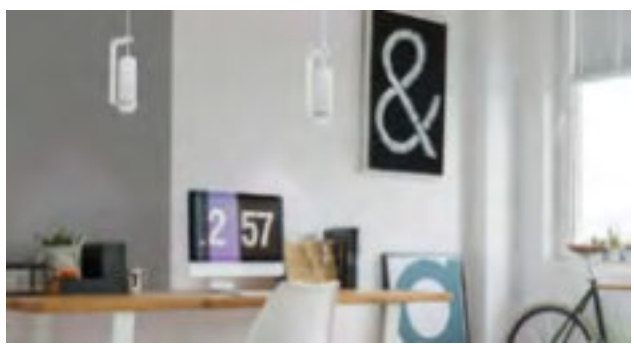

SKU	9061	9060
Color	White	Black



SKU	9047	9049	9046	9048
Color	Bronze	Antique Gold	Pearl Black	Rose Gold

LED PENDANT			
E27 Fitting			
Socket	E27	Material	Aluminium
Input Voltage	AC220-240V 50Hz	Max Power	60W
Size	100x1120mm	IP Rating	IP20



LED PENDANT			
E27 Fitting			
Socket	E27	Material	Aluminium
Input Voltage	AC220-240V 50Hz	Max Power	60W
Size	100x1500mm	IP Rating	IP20



SKU	9027
Color	Rope



SKU	9029	9028
Color	White	Black

LED PENDANT			
E27 Fitting			
Socket	E27	Material	Aluminium
Input Voltage	AC220-240V 50Hz	Max Power	60W
Size	100x1120mm	IP Rating	IP20





LED Ceiling Fans



LED CEILING FAN Forward of reverse function
18W -3CCT -Remote Control

Power	18W	Beam Angle	120°
Input Voltage	AC100-240V 50Hz	CRI	Ra>80
Lumens	1440lm	IP Rating	IP20
Size	ø1220mm	Dimmable	No
Material	Metal+ABS	Light	3CCT

SKU	19108	19109	19110
	Body	White	White



NEW

LED CEILING FAN Forward of reverse function
18W -3CCT -Remote Control

Power	18W	Beam Angle	120°
Input Voltage	AC100-240V 50Hz	CRI	Ra>80
Lumens	1440lm	IP Rating	IP20
Size	ø1067mm	Dimmable	No
Material	ABS	Light	3CCT

SKU	19113	19114
Body	White	Black



NEW

LED CEILING FAN Forward of reverse function
18W -3CCT -Remote Control

Power	18W	Beam Angle	120°
Input Voltage	AC100-240V 50Hz	CRI	Ra>80
Lumens	1440lm	IP Rating	IP20
Size	ø1168mm	Dimmable	No
Material	Metal-ABS	Light	3CCT

SKU	19111	19112
Body	White	Black



NEW

LED CEILING FAN Forward of reverse function
36W -3CCT -Remote Control

Power	36W	Beam Angle	120°
Input Voltage	AC100-240V 50Hz	CRI	Ra>80
Lumens	2880lm	IP Rating	IP20
Size	ø1067mm	Dimmable	No
Material	ABS	Light	3CCT

SKU	19103	19102
Body	White	Black

NEW



LED CEILING FAN - Slim Forward of reverse function
36W -3CCT -Remote Control

Power	36W	Beam Angle	120°
Input Voltage	AC100-240V 50Hz	CRI	Ra>80
Lumens	2880lm	IP Rating	IP20
Size	ø1067mm	Dimmable	Yes
Material	Metal+ABS	Light	3CCT

SKU	19104	19105	CCT	
Body	White	Black		

NEW



LED CEILING FAN Forward of reverse function
36W -3CCT -Remote Control

Power	36W	Beam Angle	120°
Input Voltage	AC100-240V 50Hz	CRI	Ra>80
Lumens	2880lm	IP Rating	IP20
Size	ø480mm	Dimmable	Yes
Material	ABS	Light	3CCT

SKU	19106	19107	CCT	
Body	White	White/Black		

NEW



LED CEILING FAN BULB E27
12W -3CCT -Remote Control

Power	12W	Beam Angle	120°
Input Voltage	AC85-265V 50Hz	CRI	Ra>80
Lumens	960lm	IP Rating	IP20
Size	ø420mm	Dimmable	Yes
Material	PC	Light	3CCT

SKU	19101	CCT	
Body	White		

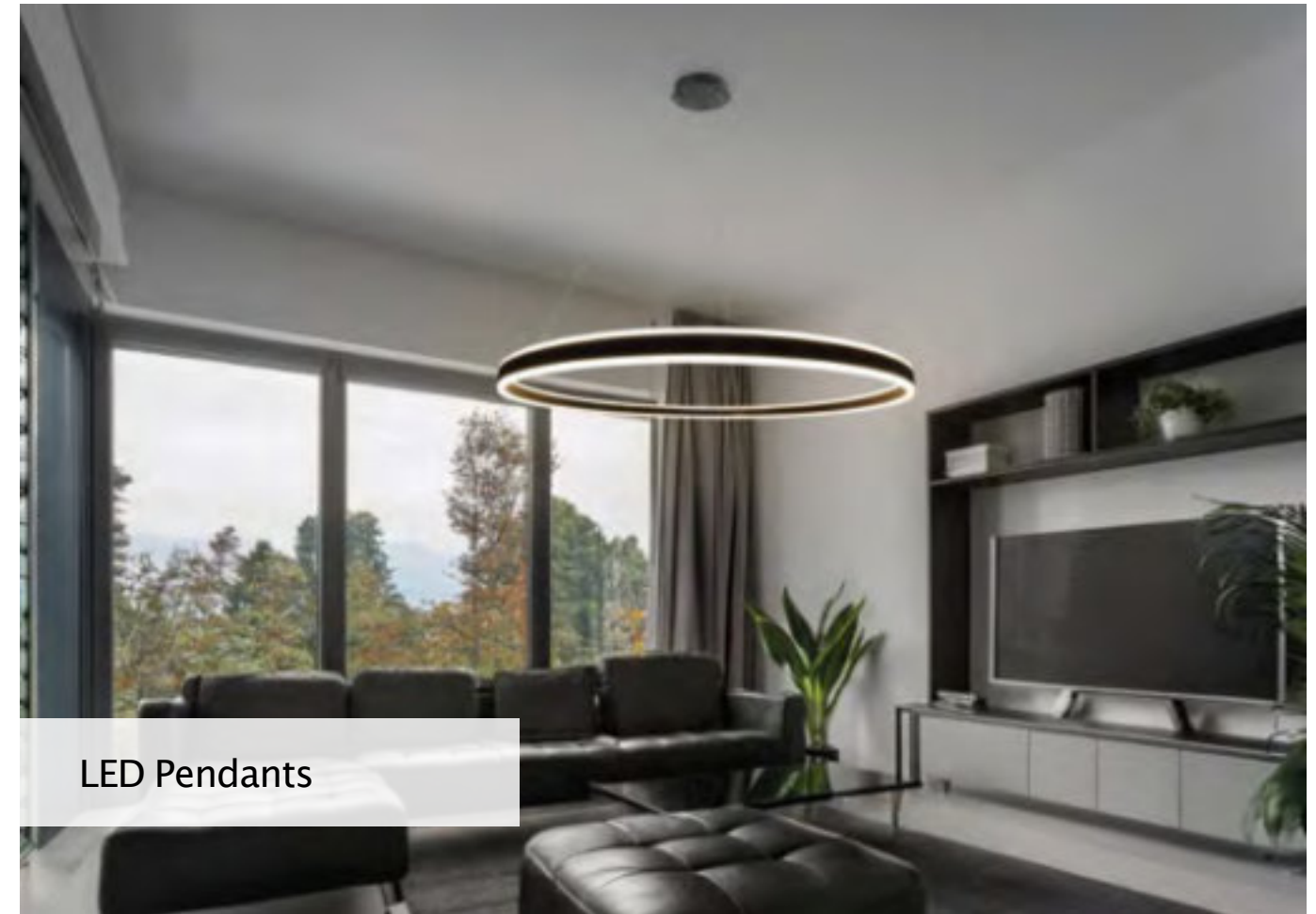

LED Pendants

NEW



LED PENDANT LAMP
40W Sand Black

Power	40W	Beam Angle	180°
Input Voltage	AC175-265V 50Hz	CRI	Ra>80
Lumens	3200lm	IP Rating	IP20
Size	ø630x30x1900mm	Dimmable	No

SKU	19065	IP20
Color	3000K	

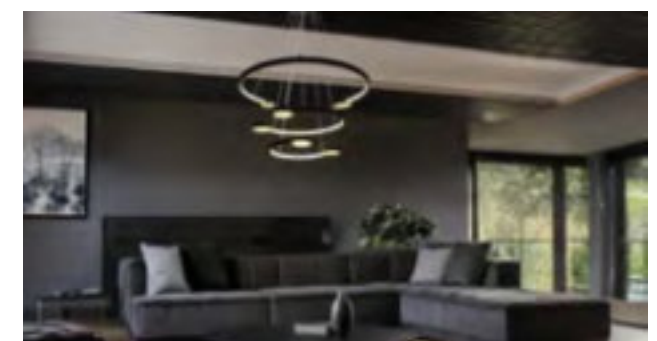

NEW



SKU 19047
Color 3000K



LED PENDANT LAMP			
13W Sand Black			
Power	13W	Beam Angle	180°
Input Voltage	AC175-265V 50Hz	CRI	Ra>80
Lumens	1040lm	IP Rating	IP20
Size	1050x150mm	Dimmable	No



NEW



SKU 19051
Color 3000K



LED PENDANT LAMP			
23W Sand Black			
Power	23W	Beam Angle	180°
Input Voltage	AC175-265V 50Hz	CRI	Ra>80
Lumens	1840lm	IP Rating	IP20
Size	ø600x100mm	Dimmable	No



NEW



SKU 19048
Color 3000K



LED PENDANT LAMP			
15W Sand Black			
Power	15W	Beam Angle	180°
Input Voltage	AC175-265V 50Hz	CRI	Ra>80
Lumens	1200lm	IP Rating	IP20
Size	ø410x190x1000mm	Dimmable	No

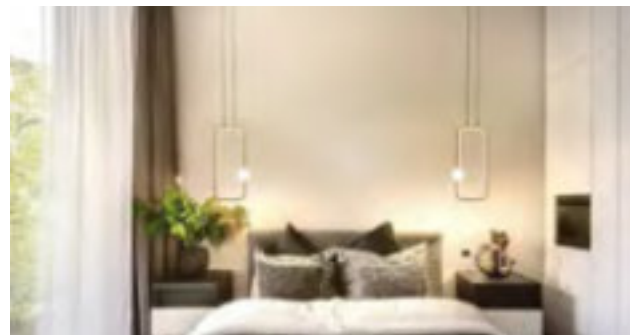

NEW

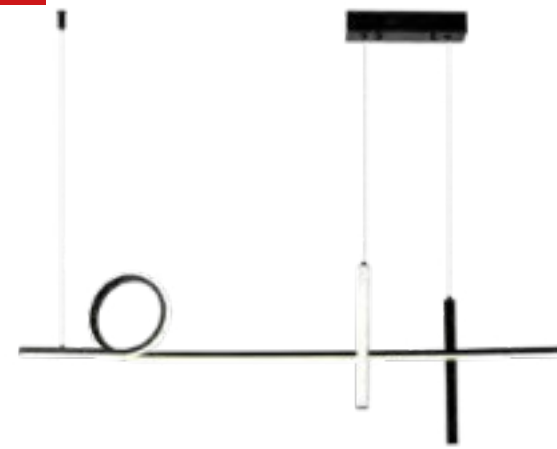

SKU 19064
Color 3000K



LED PENDANT LAMP			
24W Sand Black			
Power	24W	Beam Angle	180°
Input Voltage	AC175-265V 50Hz	CRI	Ra>80
Lumens	1920lm	IP Rating	IP20
Size	9840x260x1200mm	Dimmable	No

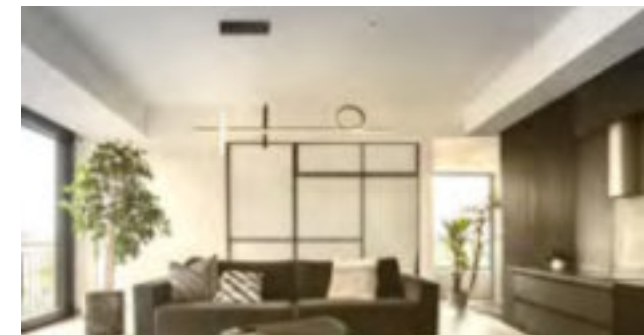

NEW



SKU 19037
Color 3000K



LED PENDANT LAMP			
17W Sand Black			
Power	17W	Beam Angle	180°
Input Voltage	AC175-265V 50Hz	CRI	Ra>80
Lumens	1360lm	IP Rating	IP20
Size	1105x175x950mm	Dimmable	No



NEW



SKU 19045
Color 3000K



LED PENDANT LAMP			
24W Sand Black			
Power	24W	Beam Angle	180°
Input Voltage	AC175-265V 50Hz	CRI	Ra>80
Lumens	1920lm	IP Rating	IP20
Size	1000x21x1250mm	Dimmable	No



NEW



SKU 19041
Color 3000K



LED PENDANT LAMP			
25W Sand Black			
Power	25W	Beam Angle	180°
Input Voltage	AC175-265V 50Hz	CRI	Ra>80
Lumens	2000lm	IP Rating	IP20
Size	1050x150x1300mm	Dimmable	No



NEW



SKU 19066
Color 3000K



LED PENDANT LAMP			
27W Copper +White			
Power	27W	Beam Angle	180°
Input Voltage	AC175-265V 50Hz	CRI	Ra>80
Lumens	2160lm	IP Rating	IP20
Size	ø600x90x1500mm	Dimmable	No



NEW



SKU 19038
Color 3000K



LED PENDANT LAMP			
28W Sand Black			
Power	28W	Beam Angle	180°
Input Voltage	AC175-265V 50Hz	CRI	Ra>80
Lumens	2240lm	IP Rating	IP20
Size	1200x190x950mm	Dimmable	No

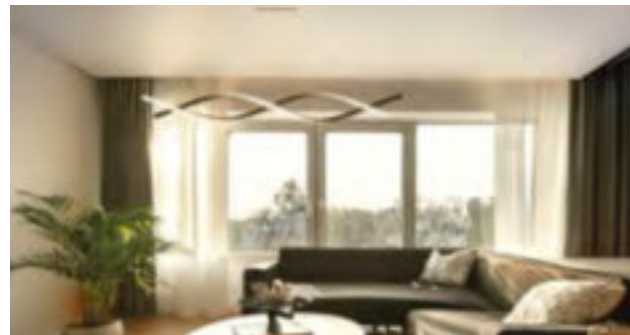

NEW



SKU 19069
Color 3000K



LED PENDANT LAMP			
35W Copper			
Power	35W	Beam Angle	180°
Input Voltage	AC175-265V 50Hz	CRI	Ra>80
Lumens	2800lm	IP Rating	IP20
Size	ø785x1500mm	Dimmable	No



NEW



SKU 19052
Color 3000K



LED PENDANT LAMP			
30W Sand Black			
Power	30W	Beam Angle	180°
Input Voltage	AC175-265V 50Hz	CRI	Ra>80
Lumens	2400lm	IP Rating	IP20
Size	1000x300x100mm	Dimmable	No



NEW



SKU 19071
Color 3000K



LED PENDANT LAMP			
36W Black			
Power	36W	Beam Angle	180°
Input Voltage	AC175-265V 50Hz	CRI	Ra>80
Lumens	2880lm	IP Rating	IP20
Size	1000x950x950mm	Dimmable	No



NEW

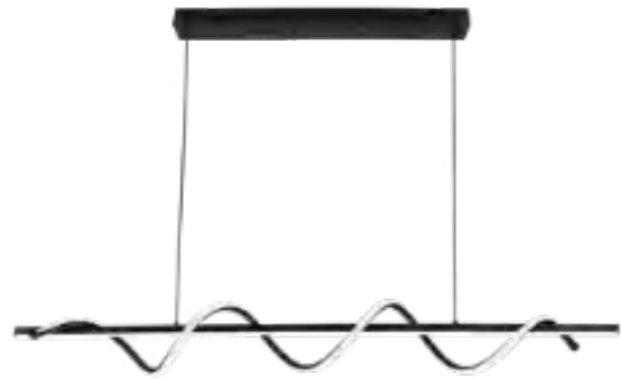

SKU 19040
Color 3000K



LED PENDANT LAMP			
30W Sand Black			
Power	30W	Beam Angle	180°
Input Voltage	AC175-265V 50Hz	CRI	Ra>80
Lumens	2400lm	IP Rating	IP20
Size	1200x150x950mm	Dimmable	No



NEW



SKU 19035
Color 3000K



LED PENDANT LAMP			
36W Sand Black			
Power	36W	Beam Angle	180°
Input Voltage	AC175-265V 50Hz	CRI	Ra>80
Lumens	2880lm	IP Rating	IP20
Size	ø600x46x1450mm	Dimmable	No



NEW



SKU 19039
Color 3000K



LED PENDANT LAMP			
67W Sand Black			
Power	67W	Beam Angle	180°
Input Voltage	AC175-265V 50Hz	CRI	Ra>80
Lumens	5360lm	IP Rating	IP20
Size	800x400x1500mm	Dimmable	No



NEW



SKU 19036
Color 3000K



LED PENDANT LAMP			
60W Sand Black			
Power	60W	Beam Angle	180°
Input Voltage	AC175-265V 50Hz	CRI	Ra>80
Lumens	4800lm	IP Rating	IP20
Size	ø1000x50x1450mm	Dimmable	No



NEW



SKU 19046
Color 3000K



LED PENDANT LAMP			
36W Sand Black			
Power	36W	Beam Angle	180°
Input Voltage	AC175-265V 50Hz	CRI	Ra>80
Lumens	2880lm	IP Rating	IP20
Size	ø630x96x1500mm	Dimmable	No

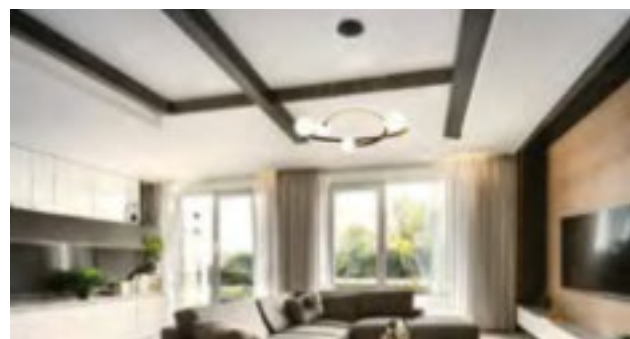

NEW



SKU 19034
Color 3000K



LED PENDANT LAMP			
70W Sand Black			
Power	70W	Beam Angle	180°
Input Voltage	AC175-265V 50Hz	CRI	Ra>80
Lumens	5600lm	IP Rating	IP20
Size	1400x42x1500mm	Dimmable	No



NEW



SKU	19001	19002	19003
Color	White	Black	Gold



LED PENDANT LAMP			
30W CCT -Dimmable +Remote Control			
Power	30W	Beam Angle	180°
Input Voltage	AC220-240V 50Hz	CRI	Ra>80
Lumens	2080lm	IP Rating	IP20
Size	ø500x20x1000mm	Dimmable	YES



NEW



SKU	White 19032	Black 19031	Gold 19033
Color	3000K	3000K	3000K



LED PENDANT LAMP			
22W			
Power	22W	Beam Angle	180°
Input Voltage	AC175-265V 50Hz	CRI	Ra>80
Lumens	1760lm	IP Rating	IP20
Size	ø600x38x1400mm	Dimmable	No



NEW



SKU	White 19043	Black 19042	Gold 19044
Color	3000K	3000K	3000K



LED PENDANT LAMP			
30W			
Power	30W	Beam Angle	180°
Input Voltage	AC175-265V 50Hz	CRI	Ra>80
Lumens	2400lm	IP Rating	IP20
Size	ø585x135x1500mm	Dimmable	No



NEW



SKU	Black* 19068	Brass** 19067
Color	3000K	3000K

LED PENDANT LAMP			
10W* ; 11W**			
Power	10W ; 11W	Beam Angle	180°
Input Voltage	AC175-265V 50Hz	CRI	Ra>80
Lumens	800lm ; 880	IP Rating	IP20
Size	10W -ø200x480mm 11W -ø250x535mm	Dimmable	No



NEW



SKU	19004	19005	19006
Color	White	Black	Gold



LED PENDANT LAMP			
78W CCT -Dimmable +Remote Control			
Power	78W	Beam Angle	180°
Input Voltage	AC220-240V 50Hz	CRI	Ra>80
Lumens	4480lm	IP Rating	IP20
Size	ø615x27x1000mm	Dimmable	YES



NEW

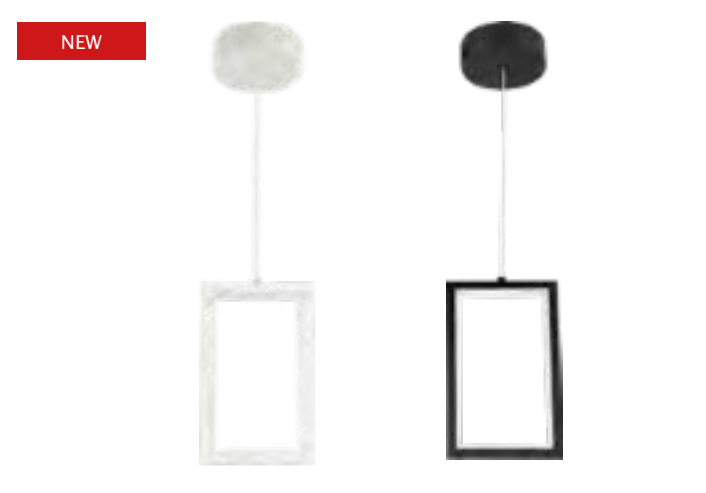

SKU	White 19050	Black 19049
Color	3000K	3000K

LED PENDANT LAMP			
4W			
Power	4W	Beam Angle	180°
Input Voltage	AC175-265V 50Hz	CRI	Ra>80
Lumens	320W	IP Rating	IP20
Size	123x203x1000mm	Dimmable	No



NEW



SKU	19058
Color	3000K



LED CEILING/WALL LAMP

9W SandBlack

Power	9W	Beam Angle	180°
Input Voltage	AC175-265V 50Hz	CRI	Ra>80
Lumens	720lm	IP Rating	IP20
Size	593x81x65mm	Dimmable	No



NEW



	White	Black	Gold
SKU	19061	19060	19062
Color	3000K	3000K	3000K



LED CEILING/WALL LAMP

10W -3000K

Power	10W	Beam Angle	180°
Input Voltage	AC175-265V 50Hz	CRI	Ra>80
Lumens	800lm	IP Rating	IP20
Size	100x550mm	Dimmable	No

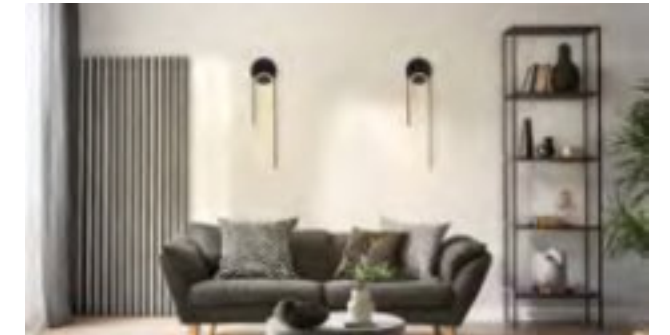

NEW



SKU	19059
Color	3000K



LED CEILING/WALL LAMP

21W Sand Black

Power	21W	Beam Angle	180°
Input Voltage	AC175-265V 50Hz	CRI	Ra>80
Lumens	1680lm	IP Rating	IP20
Size	997x140x48mm	Dimmable	No

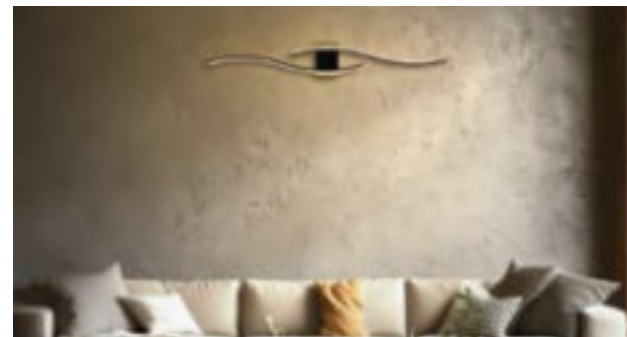

NEW



	White	Black
SKU	2095	2096
Color	3000K	3000K



LED CEILING/WALL LAMP

12W

Power	12W	Beam Angle	160°
Input Voltage	AC220-240V 50Hz	CRI	Ra>80
Lumens	600lm	IP Rating	IP20
Size	316x90x30mm	Dimmable	No

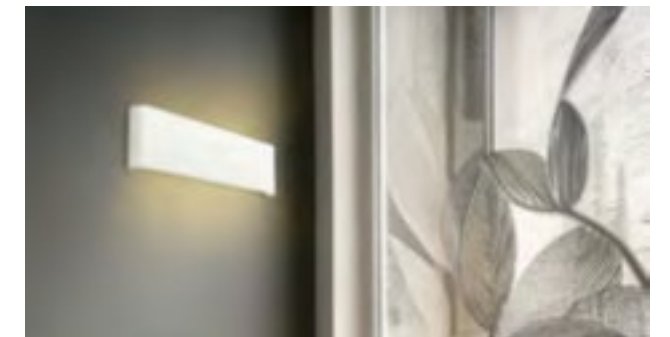

NEW



SKU	2093	2094
Color	4500K	3000K



LED CEILING/WALL LAMP

16W Black

Power	16W	Beam Angle	90°
Input Voltage	AC220-240V 50Hz	CRI	Ra>80
Lumens	1120lm	IP Rating	IP20
Size	ø60x810x105mm	Dimmable	No

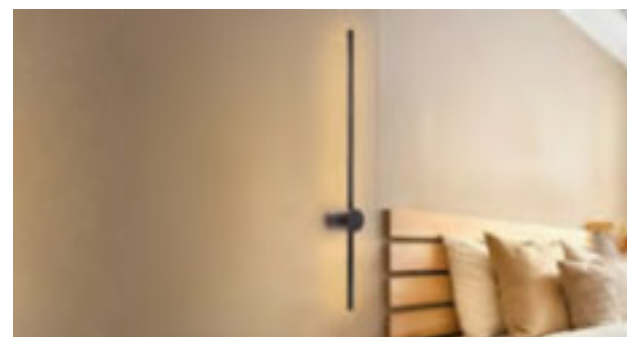

NEW



	White	White	Black	Black
SKU	7551	7552	7553	7554
Color	4000K	3000K	4000K	3000K



LED MIRROR/WALL LAMP

14W -Adjustable

Power	14W	Beam Angle	120°
Input Voltage	AC220-240V 50Hz	CRI	Ra>80
Lumens	910lm	IP Rating	IP20
Size	618x220x60mm	Dimmable	No



NEW



SKU	White 273	Black 274
Color	CCT	CCT



LEDTABLE LAMP			
3W CCT -Magnetic			
Charging	USB-C cable	Beam Angle	150°
Battery	1200mAh	CRI	Ra>80
Lumens	240lm	IP Rating	IP20
Size	82x52x336	Dimmable	Yes

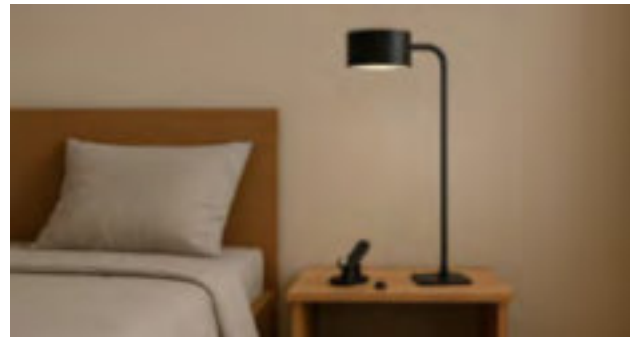

NEW



SKU	White 262	Black 261
Color	CCT	CCT



LED DESK LAMP			
5W CCT -Wireless Charging			
Charging	USB-C cable	Beam Angle	120°
Input Voltage	DC 5V	CRI	Ra>80
Lumens	380lm	IP Rating	IP20
Size	115x173x330mm	Dimmable	Yes



NEW



SKU	White 271	Black 272
Color	4000K	4000K



LEDTABLE LAMP			
3W -Magnetic			
Charging	USB-C cable	Beam Angle	5-90°
Battery	1200mAh	CRI	Ra>80
Lumens	240lm	IP Rating	IP20
Size	ø34x135mm	Dimmable	Yes



NEW



SKU	White 264	Black 263
Color	CCT	CCT



LED DESK LAMP			
7W CCT -Wireless Charging			
Charging	USB-C cable	Beam Angle	120°
Input Voltage	DC 5V	CRI	Ra>80
Lumens	380lm	IP Rating	IP20
Size	190x115x400mm	Dimmable	Yes



NEW



SKU	Khaki 275
Color	CCT



LEDTABLE LAMP			
4W -Magnetic			
Charging	USB-C cable	Beam Angle	120°
Battery	2x1200mAh	CRI	Ra>80
Lumens	400lm	IP Rating	IP20
Size	ø180x349mm	Dimmable	Yes



NEW



SKU	White 266	Black 265
Color	CCT	CCT



RECHARGEABLE LED DESK LAMP			
7W CCT -Battery			
Charging	USB-C cable	Beam Angle	120°
Battery	2000mAh	CRI	Ra>80
Lumens	300lm	IP Rating	IP20
Size	185x115x390mm	Dimmable	Yes



NEW



LED SOLAR TABLE LAMP

2.5W CCT -Battery

Charging	USB-C cable	Beam Angle	120°
Battery	2x2200mAh	CRI	Ra>80
Lumens	280lm	IP Rating	IP54
Size	ø128x300mm	Dimmable	Yes



SKU	White 252	Black 251	Beige 253
Color	CCT	CCT	CCT

Solar Power TouchControl

NEW



LED INTERIOR LAMP

12W

Power	12W	Beam Angle	180°
Input Voltage	AC175-265V 50Hz	CRI	Ra>80
Lumens	960lm	IP Rating	IP20
Size	ø210x380mm	Dimmable	No



SKU	White 19056	Black 19055	Gold 19057
Color	3000K	3000K	3000K

IP20

NEW



LED TABLE LAMP

2.5W CCT -Battery

Charging	USB-C cable	Beam Angle	120°
Battery	2x2200mAh	CRI	Ra>80
Lumens	280lm	IP Rating	IP54
Size	ø104x315mm	Dimmable	Yes

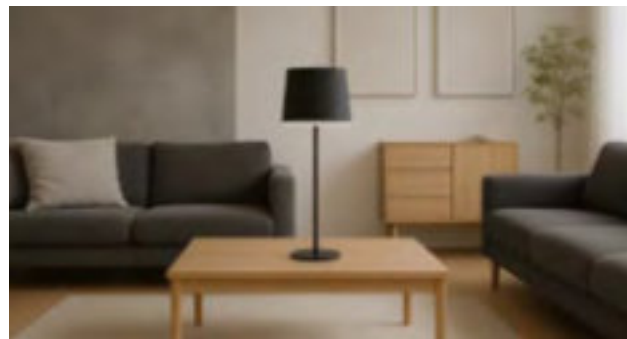

SKU	White 255	Black 254	Beige 256
Color	CCT	CCT	CCT

TouchControl

NEW



LED INTERIOR LAMP

7W -Sand Black

Power	7W	Beam Angle	360°
Input Voltage	AC2175-265V 50Hz	CRI	Ra>80
Lumens	560lm	IP Rating	IP20
Size	ø200x300mm	Dimmable	No



SKU	Black 19054
Color	3000K

IP20

NEW



LED TABLE LAMP

2.5W CCT -Battery

Charging	USB-C cable	Beam Angle	120°
Battery	2x1500mAh	CRI	Ra>80
Lumens	230lm	IP Rating	IP44
Size	ø11x360mm	Dimmable	Yes

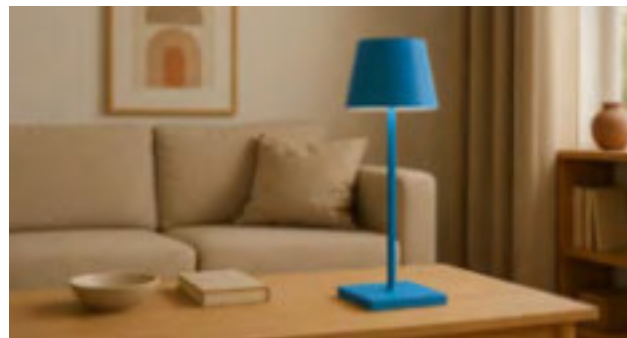

SKU	White 268	Black 267	Gray 269	Blue 270
Color	CCT	CCT	CCT	CCT

TouchControl

NEW



LED INTERIOR LAMP

E27 Socket -Bulb NOTincluded

Socket	1xE27	Material	Iron
Input Voltage	AC220-240V 50Hz	Cable Length	150cm
Size	ø210x380mm	IP Rating	IP20



SKU	260
Color	Bronze

IP20



SKU	239
Color	RGB+CW



LED FLOOR LIGHT			
8W RGB +CW -Remote Control			
Voltage	DC 5V 2A	Beam Angle	120°
Adapter	No	CRI	Ra>80
Lumens	220lm	IP Rating	IP20
Size	ø30x1047mm	Dimmable	Yes

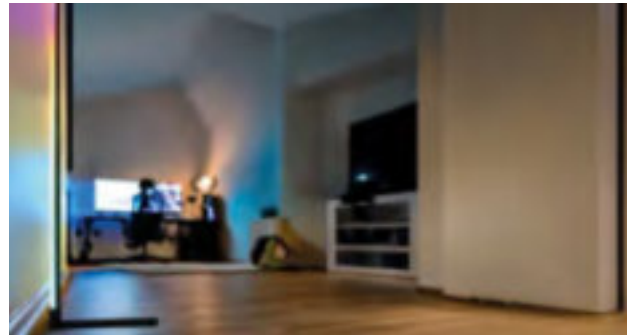

SKU	White 7584	White 7583	Black 7582	Black 7581
Color	4200K	3000K	4200K	3000K

LED CABINET LIGHT			
2W -ON/OFF Switch			
Power	2W	Beam Angle	38°
Input Voltage	AC220-240V 50Hz	CRI	Ra>80
Lumens	140lm	IP Rating	IP20
Size	φ60x140mm	Dimmable	No



SKU	238
Color	RGB+WW



LED FLOOR LIGHT			
17W RGB +WW -Remote Control			
Voltage	DC12V / 1.5A	Beam Angle	120°
Adapter	Yes -220V	CRI	Ra>80
Lumens	400lm	IP Rating	IP20
Size	ø23.5x1462mm	Dimmable	Yes

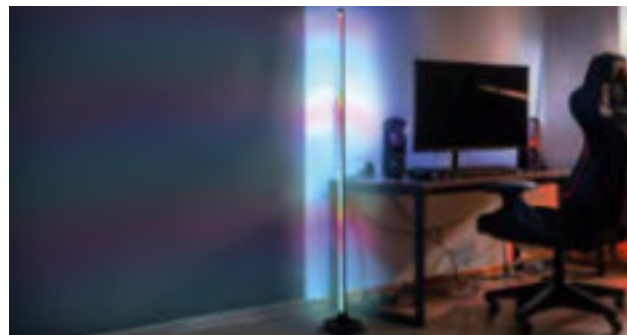

SKU	White 7592	White 7591	Black 7589	Black 7590
Color	4200K	3000K	4200K	3000K

LED CABINET LIGHT			
8W -ON/OFFSwitch+USB AandUSBC			
Power	2W	Beam Angle	38°
Input Voltage	AC220-240V 50Hz	CRI	Ra>80
Lumens	700lm	IP Rating	IP20
Size	φ145x80mm	Dimmable	No



SKU	237
Color	RGB+WW



LED FLOOR LIGHT			
20W RGB+WW -Remote Control			
Voltage	DC12V / 1.5A	Beam Angle	120°
Adapter	Yes -220V	CRI	Ra>80
Lumens	500lm	IP Rating	IP20
Size	13x1045mm	Dimmable	Yes



SKU	White 7588	White 7587	Black 7586	Black 7585
Color	4200K	3000K	4200K	3000K

LED CABINET LIGHT			
8W -ON/OFFSwitch+USB AandUSBC			
Power	8W	Beam Angle	38°
Input Voltage	AC220-240V 50Hz	CRI	Ra>80
Lumens	700lm	IP Rating	IP20
Size	φ145x80mm	Dimmable	No



NEW



LED CABINET LIGHT			
11W - ON/OFF Switch + USB A and USB C			
Power	11W	Beam Angle	280°
Input Voltage	AC220-240V 50Hz	CRI	Ra>80
Lumens	700lm	IP Rating	IP20
Size	300x80x126mm	Dimmable	No



SKU	7594	7593
Color	4200K	3000K



	Black	Silver
SKU	240	241
Color	3000K	3000K



LED CABINET LIGHT			
1.5W PIR Sensor - Slim Fit - Battery			
Charging	USB-C cable 5V	Beam Angle	120°
Battery	3.7V 900mAh	CRI	Ra>80
Lumens	100lm	IP Rating	IP20
Size	240x40x10mm	Dimmable	No



LED CABINET LIGHT			
0.5W Magnetic Control - Battery			
Voltage	DC:1.5V	Beam Angle	120°
Battery	2*AAA	CRI	Ra>80
Lumens	40lm	IP Rating	IP20
Size	64x43x15mm	Dimmable	No



SKU	233	234
Color	4500K	3000K



	Black	Silver
SKU	242	243
Color	3000K	3000K



LED CABINET LIGHT			
3.5W PIR Sensor - Slim Fit - Battery			
Charging	USB-C cable 5V	Beam Angle	120°
Battery	3.7V 2200mAh	CRI	Ra>80
Lumens	230lm	IP Rating	IP20
Size	600x40x10mm	Dimmable	No



LED CABINET LIGHT			
3.5W PIR Sensor - Slim Fit - Battery			
Charging	USB-C cable 5V	Beam Angle	120°
Battery	3.7V 2200mAh	CRI	Ra>80
Lumens	230lm	IP Rating	IP20
Size	600x40x10mm	Dimmable	No



SKU	235	236
Color	4500K	3000K



LED CABINET LIGHT			
PIR Sensor - Slim Fit - Battery			
Charging	USB-C cable 5V	Beam Angle	120°
Color	Silver	CRI	Ra>80
Dimmable	No	IP Rating	IP20

SKU	Watt	Lumen	Color	Dimension
230	1.5W	140lm	4500K	300x40x9 mm
231	1.5W	140lm	3000K	300x40x9 mm
232	2.5W	200lm	CCT	400x41x16.5mm



Retro Lamps

NEW



PORTABLE RETRO LED LAMP
2.6W Filament -CCT

Power	2.6W	Beam Angle	270°
Voltage	DC 3.7V	CRI	Ra>80
Lumens	8-110lm	IP Rating	IP44
Size	115x115x115mm	Dimmable	Yes

SKU: 249
Color: CCT

Icons: Dimmable, 950mAh, IP44

NEW



PORTABLE RETRO LED LAMP
3W Filament -CCT

Power	2.6 W	Beam Angle	270°
Voltage	DC 3.7V	CRI	Ra>80
Lumens	20-160lm	IP Rating	IP44
Size	110x110x180mm	Dimmable	No

SKU: 250
Color: CCT

Icons: Dimmable, 650mAh, IP44



LED FLAME BULB -THREE MODE
5W SMD E27

Power	5 W	Beam Angle	360°
Input Voltage	AC100-240V 50Hz	CRI	Ra>80
Lumens	250lm	Socket	E27
Size	ø47x125mm	Dimmable	No

SKU: 222
Color: 1300K

Icon: IP20



LED FLAME LAMP
5W SMD /Battery -LED Flame Bulb Included

Power	5W	Beam Angle	360°
Input Voltage	AC100-240V 50Hz	CRI	Ra>80
Lumens	250lm	IP Rating	IP20
Size	ø180x285mm	Dimmable	No

Battery

SKU: 9041 | 9042
Color: 1300K | 1300K

Icons: 650mAh, IP20



LED FLAME LAMP
Wall Mounted -LED Flame Bulb Included

Power	5W	Beam Angle	360°
Input Voltage	AC100-240V 50Hz	CRI	Ra>80
Lumens	250lm	IP Rating	IP20
Size	220x285mm	Dimmable	No

SKU: 9044
Color: 1300K

Icon: IP20



LED FLAME LAMP
Wall Mounted -LED Flame Bulb Included

Power	5W	Beam Angle	360°
Input Voltage	AC100-240V 50Hz	CRI	Ra>80
Lumens	250lm	IP Rating	IP20
Size	180x285mm	Dimmable	No

SKU: 9045
Color: 1300K

Icon: IP20



LED FLAME LAMP
Hanging -LED Flame Bulb Included

Power	5W	Beam Angle	360°
Input Voltage	AC100-240V 50Hz	CRI	Ra>80
Lumens	250lm	IP Rating	IP20
Size	ø150x330mm	Dimmable	No

SKU: 9043
Color: 1300K

Icon: IP20



LED Tubes and Fixtures

LED tubes and battens deliver a smart, energy-efficient upgrade to outdated fluorescent systems. Designed for seamless installation, they provide powerful, even illumination while drastically reducing energy consumption and maintenance costs. With a variety of lengths, wattages, and colour temperatures, they adapt perfectly to any environment—whether for everyday home lighting, professional office setups, or demanding industrial spaces.

Features:

- Up to 85% energy savings compared to fluorescent tubes
- Long service life for reduced replacement and maintenance
- Wide choice of colour temperatures to match any space
- Standard sizes to fit existing tube or batten fixtures
- Options for single- or double-end power connection
- Sturdy, high-quality materials with covers in nano-plastic, polycarbonate, or glass

Applications:

- Residential use in kitchens, garages, and basements
- Commercial and retail lighting for offices, shops, and showrooms
- Industrial use in warehouses, factories, and production areas
- Reliable main lighting for corridors, parking areas, and utility spaces



LED TUBE T5 -Plastic	
Matt With Switch	
Input Voltage	220-240V 50/60Hz
Beam Angle	120°
CRI	Ra>80
IP Rating	IP20
Dimmable	No

SKU	Watt	Lumen	Lumen/W	Color	Dimension
5588	3.4W	300lm	88lm/W	6000K	330x20x30mm
5589	3.4W	300lm	88lm/W	4000K	330x20x30mm
5590	3.4W	300lm	88lm/W	3000K	330x20x30mm
5591	6.5W	600lm	92lm/W	6000K	590x20x30mm
5592	6.5W	600lm	92lm/W	4000K	590x20x30mm
5593	6.5W	600lm	92lm/W	3000K	590x20x30mm
5594	9.6W	900lm	94lm/W	6000K	890x20x30mm
5595	9.6W	900lm	94lm/W	4000K	890x20x30mm
5596	9.6W	900lm	94lm/W	3000K	890x20x30mm
5597	13W	1200lm	92lm/W	6000K	1190x20x30mm
5598	13W	1200lm	92lm/W	4000K	1190x20x30mm
5599	13W	1200lm	92lm/W	3000K	1190x20x30mm



LED TUBE T5 -Plastic	
Matt With Switch	
Input Voltage	220-240V 50/60Hz
Beam Angle	120°
CRI	Ra>80
IP Rating	IP20
Dimmable	No

SKU	Watt	Lumen	Lumen/W	Color	Dimension
5567	4W	320lm	80lm/W	2700K	310x28mm
5569	8W	640lm	80lm/W	4000K	570x28mm
5571	12W	960lm	80lm/W	6000K	870x28mm
5572	12W	960lm	80lm/W	4000K	870x28mm
5573	12W	960lm	80lm/W	2700K	870x28mm
5574	16W	1280lm	80lm/W	6000K	1170x28mm
5575	16W	1280lm	80lm/W	4000K	1170x28mm
5576	16W	1280lm	80lm/W	2700K	1170x28mm
5577	20W	1600lm	80lm/W	6000K	1450x28mm
5578	20W	1600lm	80lm/W	4000K	1450x28mm
5579	20W	1600lm	80lm/W	2700K	1450x28mm



LED TUBE T5 -Plastic	
Matt	
Input Voltage	220-240V 50/60Hz
Beam Angle	120°
CRI	Ra>80
IP Rating	IP20
Dimmable	No

SKU	Watt	Lumen	Lumen/W	Color	Dimension
5501	3.4W	300lm	88lm/W	6000K	330x20x30mm
5502	3.4W	300lm	88lm/W	4000K	330x20x30mm
5503	3.4W	300lm	88lm/W	3000K	330x20x30mm
5504	6.5W	600lm	92lm/W	6000K	590x20x30mm
5505	6.5W	600lm	92lm/W	4000K	590x20x30mm
5506	6.5W	600lm	92lm/W	3000K	590x20x30mm
5507	9.6W	900lm	94lm/W	6000K	890x20x30mm
5508	9.6W	900lm	94lm/W	4000K	890x20x30mm
5509	9.6W	900lm	94lm/W	3000K	890x20x30mm
5538	13W	1200lm	92lm/W	6000K	1190x20x30mm
5539	13W	1200lm	92lm/W	4000K	1190x20x30mm
5540	13W	1200lm	92lm/W	3000K	1190x20x30mm



LED TUBE T5 -Plastic	
Matt	
Input Voltage	220-240V 50/60Hz
Beam Angle	120°
CRI	Ra>80
IP Rating	IP20
Dimmable	No

SKU	Watt	Lumen	Lumen/W	Color	Dimension
5550	4W	320lm	80lm/W	6000K	310x28mm
5551	4W	320lm	80lm/W	4000K	310x28mm
5552	4W	320lm	80lm/W	2700K	310x28mm
5554	8W	640lm	80lm/W	4000K	570x28mm
5555	8W	640lm	80lm/W	2700K	570x28mm
5556	12W	960lm	80lm/W	6000K	870x28mm
5557	12W	960lm	80lm/W	4000K	870x28mm
5558	12W	960lm	80lm/W	2700K	870x28mm
5560	16W	1280lm	80lm/W	4000K	1170x28mm
5561	16W	1280lm	80lm/W	2700K	1170x28mm
5562	20W	1600lm	80lm/W	6000K	1450x28mm
5563	20W	1600lm	80lm/W	3000K	1450x28mm
5564	20W	1600lm	80lm/W	2700K	1450x28mm

NEW



LED TUBE T8 -STARTER
Nano Plastic -One Side Power

Input Voltage	220-240V 50/60Hz
Beam Angle	270°
CRI	Ra>80
IP Rating	IP20
Dimmable	No

SKU	Watt	Lumen	Lumen/W	Color	Dimension
15541	9W	1260lm	140lm/W	6000K	Φ28x600mm
15542	9W	1260lm	140lm/W	4000K	Φ28x600mm
15544	18W	2520lm	140lm/W	6000K	Φ28x1200mm
15545	18W	2520lm	140lm/W	4000K	Φ28x1200mm
15547	22W	3080lm	140lm/W	6000K	Φ28x1500mm
15548	22W	3080lm	140lm/W	4000K	Φ28x1500mm



LED TUBE T8 -GLASS
City Line -One Side Power

Input Voltage	175-265V 50/60Hz
Beam Angle	270°
CRI	Ra>80
IP Rating	IP20
Dimmable	No

SKU	Watt	Lumen	Lumen/W	Color	Dimension
5601	9W	900lm	100lm/W	6000K	Φ25x600mm
5602	9W	900lm	100lm/W	4500K	Φ25x600mm
5603	9W	900lm	100lm/W	2800K	Φ25x600mm
5604	18W	1800lm	100lm/W	6000K	Φ25x1200mm
5605	18W	1800lm	100lm/W	4500K	Φ25x1200mm
5606	18W	1800lm	100lm/W	2800K	Φ25x1200mm
5607	22W	2400lm	110lm/W	6000K	Φ25x1500mm
5608	22W	2400lm	110lm/W	4500K	Φ25x1500mm
5609	22W	2400lm	110lm/W	2800K	Φ25x1500mm

NEW



LED TUBE T8 -STARTER
Nano Plastic -One Side Power

Input Voltage	220-240V 50/60Hz
Beam Angle	270°
CRI	Ra>80
IP Rating	IP20
Dimmable	No

SKU	Watt	Lumen	Lumen/W	Color	Dimension
15511	9W	900lm	100lm/W	6000K	Φ28x600mm
15512	9W	900lm	100lm/W	4000K	Φ28x600mm
15513	9W	900lm	100lm/W	3000K	Φ28x600mm
15514	18W	1800lm	100lm/W	6000K	Φ28x1200mm
15515	18W	1800lm	100lm/W	4000K	Φ28x1200mm
15516	18W	1800lm	100lm/W	3000K	Φ28x1200mm
15517	22W	2400lm	110lm/W	6000K	Φ28x1500mm
15518	22W	2400lm	110lm/W	4000K	Φ28x1500mm
15519	22W	2400lm	110lm/W	3000K	Φ28x1500mm

NEW



LED TUBE T8 -GLASS
CCT -One Side Power

Input Voltage	175-265V 50/60Hz
Beam Angle	270°
CRI	Ra>80
IP Rating	IP20
Dimmable	No

SKU	Watt	Lumen	Lumen/W	Colour	Dimension
15601	9W	900lm	100lm/W	CCT	Φ25x600mm
15602	18W	1800lm	100lm/W	CCT	Φ25x1500mm



LED TUBE T8 -GLASS

OneSide Power

Input Voltage	220-240V 50/60Hz
Beam Angle	270°
CRI	Ra>80
IP Rating	IP20
Dimmable	No

SKU	Watt	Lumen	Lumen/W	Color	Dimension
5626	9W	720lm	100lm/W	6000K	Φ25x600mm
5627	9W	720lm	100lm/W	4000K	Φ25x600mm
5630	18W	1440lm	80lm/W	4000K	Φ25x1200mm
5628	22W	1760lm	80lm/W	6000K	Φ25x1500mm
5631	22W	1760lm	80lm/W	4000K	Φ25x1500mm



T8 Fixture

for LED One side power tubes

Input Voltage	220-240V 50/60Hz
Max Power	100W
Material	Metal+PC
IP Rating	IP20
Dimmable	No

SKU	Socket	Tube Length	Dimension
6745	T8	60cm Tube	606x33mm
6746	T8	120cm Tube	1250x33mm
6749	T8	150cm Tube	1550x33 mm
6747	2xT8	60cm Tube	606x73mm
6748	2xT8	120cm Tube	1250x73mm
6750	2xT8	150cm Tube	1550x73 mm



Stainless Steel Clips



LED WATERPROOF FIXTURE

For one side power tubes T8

Input Voltage	220-240V 50/60Hz
Beam Angle	Max 150°
Material	PC+ALU
IP Rating	IP65
Dimmable	No

SKU	Socket	Tube Length	Dimension
16721	T8	60cm Tube	655x65x65mm
16723	T8	120cm Tube	1265x65x65mm
16725	T8	150cm Tube	1565x65x65mm
16722	2xT8	60cm Tube	655x102x65mm
16724	2xT8	120cm Tube	1265x102x65mm
16726	2xT8	150cm Tube	1565x65x65mm



LED WATERPROOF FIXTURE

For one side power tubes T8 +Reflector

Input Voltage	220-240V 50/60Hz
Beam Angle	Max 150°
Material	PC+ALU
IP Rating	IP65
Dimmable	No

SKU	Socket	Tube Length	Dimension
6650	T8	60cm Tube	655x65x65mm
6652	T8	120cm Tube	1265x65x65mm
6654	T8	150cm Tube	1565x65x65mm
6651	2xT8	60cm Tube	655x102x65mm
6653	2xT8	120cm Tube	1265x102x65mm
6655	2xT8	150cm Tube	1565x65x65mm



LED FIXTURES WITH T8 TUBES

Single -City Line -One Side Power

Input Voltage	220-240V 50/60Hz
Beam Angle	180°
CRI	Ra>80
IP Rating	IP65
Dimmable	No

SKU	Watt	Lumen	Lumen/W	Color	Dimension
6731	9W	900lm	100lm/W	6000K	680x67x63 mm
6732	9W	900lm	100lm/W	4500K	680x67x63 mm
6735	18W	1800lm	100lm/W	6000K	128x67x63mm
6736	18W	1800lm	100lm/W	4500K	128x67x63mm
6739	22W	2200lm	100lm/W	6000K	1585x67x63mm
6740	22W	2200lm	100lm/W	4500K	1585x67x63mm



LED WATERPROOF FIXTURE

Linkable

Input Voltage	220-240V 50/60Hz
Beam Angle	180°
CRI	Ra>80
IP Rating	IP65
Dimmable	No

SKU	Watt	Lumen	Lumen/W	Color	Dimension
16701	40W	4400lm	110lm/W	6000K	1186x70x60mm
16702	40W	4400lm	110lm/W	4500K	1186x70x60mm
16705	40W	4400lm	110lm/W	6000K	1186x70x60mm
16706	40W	4400lm	110lm/W	4500K	1186x70x60mm
16709	40W	4400lm	110lm/W	6000K	1186x70x60mm
16710	40W	4400lm	110lm/W	4500K	1186x70x60mm
16713	40W	5600lm	140lm/W	6000K	1486x70x60mm
16714	40W	5600lm	140lm/W	4500K	1486x70x60mm
16703	55W	6050lm	110lm/W	6000K	1486x70x60mm
16704	55W	6050lm	110lm/W	4500K	1486x70x60mm
16707	55W	6050lm	110lm/W	6000K	1486x70x60mm
16708	55W	6050lm	110lm/W	4500K	1486x70x60mm
16711	55W	6050lm	110lm/W	6000K	1486x70x60mm
16712	55W	6050lm	110lm/W	4500K	1486x70x60mm



LED FIXTURES WITH T8 TUBES

Double -City Line -One Side Power

Input Voltage	220-240V 50/60Hz
Beam Angle	180°
CRI	Ra>80
IP Rating	IP65
Dimmable	No

SKU	Watt	Lumen	Lumen/W	Color	Dimension
6733	2x9W	1800lm	100lm/W	6000K	680x113x63mm
6734	2x9W	1800lm	100lm/W	4500K	680x113x63 mm
6737	2x18W	3600lm	100lm/W	6000K	1285x113x63mm
6738	2x18W	3600lm	100lm/W	4500K	1285x113x63mm
6741	2x22W	4000lm	100lm/W	6000K	1585x113x63mm
6742	2x22W	4000lm	100lm/W	4500K	1585x113x63mm



LED WATERPROOF FIXTURE

Stainless steel clips

Input Voltage	220-240V 50/60Hz
Beam Angle	180°
CRI	Ra>80
IP Rating	IP65
Dimmable	No



SKU	Watt	Lumen	Lumen/W	Color	Dimension
6701	40W	4400lm	110lm/W	6000K	1186x70x60mm
6702	40W	4400lm	110lm/W	4500K	1186x70x60mm
6705	40W	4400lm	110lm/W	6000K	1186x70x60mm
6706	40W	4400lm	110lm/W	4500K	1186x70x60mm
6709	40W	4400lm	110lm/W	6000K	1186x70x60mm
6710	40W	4400lm	110lm/W	4500K	1186x70x60mm
6703	55W	6050lm	110lm/W	6000K	1486x70x60mm
6704	55W	6050lm	110lm/W	4500K	1486x70x60mm
6707	55W	6050lm	110lm/W	6000K	1486x70x60mm
6708	55W	6050lm	110lm/W	4500K	1486x70x60mm
6711	55W	6050lm	110lm/W	6000K	1486x70x60mm
6712	55W	6050lm	110lm/W	4500K	1486x70x60mm



LED WATERPROOF FIXTURE

Flicker Free with M12 Cable Gland

Input Voltage	220-240V 50/60Hz
Beam Angle	180°
CRI	Ra>80
IP Rating	IP65
Dimmable	No

SKU	Watt	Lumen	Lumen/W	Color	Dimension
6721	18W	1800lm	100lm/W	6000K	650x74x42.5mm
6722	18W	1800lm	100lm/W	4500K	650x74x42.5 mm
6723	36W	3600lm	100lm/W	6000K	1250x72x43mm
6724	36W	3600lm	100lm/W	4000K	1250x72x43 mm
6725	45W	45000lm	100lm/W	6000K	1550x72x43mm
6726	45W	4500lm	100lm/W	4000K	1550x72x43mm



LED BATTEN LIGHT

Stainless steel clips -Waterproof

Input Voltage	220-240V 50/60Hz
Beam Angle	120°
CRI	Ra>80
IP Rating	IP20
Dimmable	No

SKU	Watt	Lumen	Lumen/W	Color	Dimension
6691	20W	1660lm	83lm/W	6000K	600x75x25mm
6692	20W	1660lm	83lm/W	4000K	600x75x25mm
6694	40W	3320lm	83lm/W	6000K	1200x75x25mm
6695	40W	3320lm	83lm/W	4000K	1200x75x25mm
6697	50W	4150lm	83lm/W	6000K	1500x75x25mm
6698	50W	4150lm	83lm/W	4000K	1500x75x25mm

NEW



LED TRI-PROOFFIXTURE

Linkable

Input Voltage	220-240V 50/60Hz
Beam Angle	120°
CRI	Ra>80
IP Rating	IP65
Dimmable	No

SKU	Watt	Lumen	Lumen/W	Color	Dimension
16741	20W	2400lm	120lm/W	6000K	691x61x55mm
16742	20W	2400lm	120lm/W	4000K	691x61x55mm
16743	36W	4320lm	120lm/W	6000K	1241x61x55mm
16744	36W	4320lm	120lm/W	4000K	1241x61x55mm
16745	48W	5760lm	120lm/W	6000K	1541x61x55mm
16746	48W	5760lm	120lm/W	4000K	1541x61x55mm



LED BATTEN LIGHT

Stainless steel clips

Input Voltage	220-240V 50/60Hz
Beam Angle	120°
CRI	Ra>80
IP Rating	IP20
Dimmable	No

SKU	Watt	Lumen	Lumen/W	Color	Dimension
6671	10W	1150lm	115lm/W	6000K	300x70x20mm
6672	10W	1150lm	115lm/W	4000K	300x70x20mm
6673	10W	1150lm	115lm/W	3000K	300x70x20mm
6674	20W	2300lm	115lm/W	6000K	600x70x20mm
6675	20W	2300lm	115lm/W	4000K	600x70x20mm
6676	20W	2300lm	115lm/W	3000K	600x70x20mm
6677	40W	5360lm	134lm/W	6000K	1200x70x20mm
6678	40W	5360lm	134lm/W	4000K	1200x70x20mm
6679	40W	5360lm	134lm/W	3000K	1200x70x20mm
6680	45W	6030lm	134lm/W	6000K	1500x70x20mm
6681	45W	6030lm	134lm/W	4000K	1500x70x20mm

NEW



LED BATTEN LIGHT	
CCT Light	
Input Voltage	220-240V 50/60Hz
Beam Angle	120°
CRI	Ra>80
IP Rating	IP20
Dimmable	No

SKU	Watt	Lumen	Lumen/W	Color	Dimension
16731	20W	2400lm	120lm/W	CCT	600x75x28mm
16732	40W	4800lm	120lm/W	CCT	1200x75x28mm
16733	45W	5400lm	120lm/W	CCT	1500x75x28mm



NEW



LED BATTEN FIXTURE	
Linkable -Waterproof	
Input Voltage	220-240V 50/60Hz
Beam Angle	120°
CRI	Ra>80
IP Rating	IP65
Dimmable	No

SKU	Watt	Lumen	Lumen/W	Color	Dimension
16734	18W	2250lm	125lm/W	6000K	700x43x33mm
16735	18W	2250lm	125lm/W	4000K	700x43x33mm
16736	36W	4500lm	125lm/W	6000K	1250x43x33mm
16737	36W	4500lm	125lm/W	4000K	1250x43x33mm
16738	45W	5625lm	125lm/W	6000K	1550x43x33mm
16739	45W	5625lm	125lm/W	4000K	1550x43x33mm

LEVER CONNECTORS
CAGE CLAMP®

Rated Voltage	400V	Wire Range	24to12AWG
Rated Current	32A	Impulse voltage	4kV



SKU	2-Way	3-Way
	6001	6002

LEVER CONNECTORS
Flame retardant

Rated Voltage	450V	Wire Range	24to12AWG
Rated Current	32A	Temperature	110°C



SKU	2-Way	3-Way	6-Way
	6506	6507	6508

LEVER CONNECTORS
Easy Clip

Rated Voltage	450V	Wire Range	18-12AWG
Rated Current	32A	Strip length	12-13mm



SKU	2-Way	3-Way	4-Way	5-Way	8-Way
	6501	6502	6503	6504	6505

T5 PLASTIC INPUT CABLE
DoublePin



SKU	30cm	50cm	100cm
	6628	6629	6630

T5 PLASTIC ENDCAPS
For 5501-5599



SKU	65317
-----	-------



LED Emergency Light

Emergency lighting has become a global standard, ensuring safety and compliance in all types of buildings. OPTONICA LED emergency solutions combine energy efficiency with reliability, providing peace of mind in critical moments. Designed to operate instantly when power fails, they are built to meet the needs of residential, commercial, and industrial environments alike.

Features:

- Up to 85% energy savings compared to conventional systems
- Automatic self-test with clear battery status indication
- Supplied with multiple directional pictograms for flexibility
- Up to 3 hours of dependable emergency operation
- Fast, automatic activation during power outages
- Robust construction for long-lasting reliability

Applications:

- Residential complexes and apartment buildings
- Offices, retail, and commercial spaces
- Warehouses, factories, and industrial sites
- Public buildings such as schools, hospitals, and hotels

NEW



EMERGENCY LEDEXIT SIGN			
Recessed Fixed			
Power	2W	Lumens	100 lm
Input Voltage	AC220-240V 50Hz	CRI	Ra>80
Battery	1.2V 800mAh	IP Rating	IP30
Size	385x85x195 mm	Dimmable	No
SKU	7223		
Color	6000K		

NEW



EMERGENCY LEDEXIT SIGN			
Wall /Surface Mount			
Power	3W	Lumens	150 lm
Input Voltage	AC220-240V 50Hz	CRI	Ra>80
Battery	3.7V 1800mAh	IP Rating	IP30
Size	305x55x202mm	Dimmable	No
SKU	7221		
Color	6000K		

NEW



EMERGENCY LEDEXIT SIGN			
Recessed Fixed			
Power	3W	Lumens	150 lm
Input Voltage	AC220-240V 50Hz	CRI	Ra>80
Battery	3.7V 1800mAh	IP Rating	IP20
Size	370x50x220 mm	Dimmable	No
SKU	7224		
Color	6000K		

NEW



EMERGENCY LEDEXIT SIGN			
Wall /Surface Mount			
Power	3W	Lumens	180 lm
Input Voltage	AC220-240V 50Hz	CRI	Ra>80
Battery	3.7V 1800mAh	IP Rating	IP30
Size	390x60x190 mm	Dimmable	No
SKU	7222		
Color	6000K		



EMERGENCY LEDEXIT SIGN			
Wall /Surface Mount			
Power	2W	Battery life	>3 Hours
Input Voltage	AC220-240V 50Hz	CRI	Ra>80
Battery	3.6V 900mAh Ni-Cd	IP Rating	IP20
Size	330x230x40 mm	Dimmable	No
SKU	7203		
Color	6000K		



EMERGENCY LEDEXIT SIGN			
Wall /Surface Mount			
Power	2W	Battery life	>3 Hours
Input Voltage	AC220-240V 50Hz	CRI	Ra>80
Battery	3.6V 900mAh Ni-Cd	IP Rating	IP20
Size	300x190 x14mm	Dimmable	No
SKU	7204		
Color	6000K		



EMERGENCY LEDEXIT SIGN			
Recessed Fixed			
Power	2W	Battery life	>3 Hours
Input Voltage	AC220-240V 50Hz	CRI	Ra>80
Battery	3.6V 900mAh Ni-Cd	IP Rating	IP20
Size	355x215x80 mm	Dimmable	No
SKU	7206		
Color	6000K		



EMERGENCY LEDEXIT SIGN			
Recessed Hanging			
Power	2W	Battery life	>3 Hours
Input Voltage	AC220-240V 50Hz	CRI	Ra>80
Battery	3.6V 900mAh Ni-Cd	IP Rating	IP20
Size	306x187x19 mm	Dimmable	No
SKU	7205		
Color	6000K		

NEW



EMERGENCY LEDEXIT SIGN			
Bulkhead			
Power	5W	Lumens	320 lm
Input Voltage	AC220-240V 50Hz	CRI	Ra>80
Battery	3.7V 3600mAh	IP Rating	IP30
Size	350x110x55 mm	Dimmable	No
SKU	7225		
Color	6000K		

NEW



EMERGENCY LEDEXIT SIGN			
Wall Mount			
Power	3W	Lumens	240 lm
Input Voltage	AC85-240V 50Hz	CRI	Ra>80
Battery	3.7V 2200mAh	IP Rating	IP40
Size	315x310x460 mm	Dimmable	No
SKU	7227		
Color	6000K		



EMERGENCY LEDEXIT SIGN			
Bulkhead			
Power	5W	Lumens	320 lm
Input Voltage	AC220-240V 50Hz	CRI	Ra>80
Battery	3.7V 3600mAh	IP Rating	IP65
Size	350x110x55 mm	Dimmable	No
SKU	7201	7202	
Color	6000K	Recessed kit	



EMERGENCY LEDEXIT SIGN			
Wall Mount -Self Test			
Power	3W	Lumens	280 lm
Input Voltage	AC220-240V 50Hz	CRI	Ra>80
Battery	3.6V 1800mAh	IP Rating	IP20
Size	285x270x70 mm	Dimmable	No
SKU	7208		
Color	6000K		



EMERGENCY LEDEXIT SIGN			
Wall Mount			
Power	3W	Lumens	140 lm
Input Voltage	AC220-240V 50Hz	CRI	Ra>80
Battery	3.6V 1200mAh	IP Rating	IP20
Size	370x180x25 mm	Dimmable	No
SKU	7207		
Color	6000K		



EMERGENCY LEDEXIT SIGN			
Wall Mount -Self Test			
Power	6W	Lumens	450 lm
Input Voltage	AC220-240V 50Hz	CRI	Ra>80
Battery	3.6V 3000mAh	IP Rating	IP20
Size	280x260x60 mm	Dimmable	No
SKU	7209		
Color	6000K		

NEW



EMERGENCY LEDEXIT SIGN			
Wall Mount			
Power	3W	Lumens	280 lm
Input Voltage	AC220-240V 50Hz	CRI	Ra>80
Battery	3.7V 1200mAh	IP Rating	IP20
Size	202x55x30 mm	Dimmable	No
SKU	7226		
Color	6000K		



EMERGENCY LEDEXIT SIGN			
Downlight			
Power	3W	CRI	Ra>80
Input Voltage	AC220-240V 50Hz	IP Rating	IP20
Size	200x95x50mm	Dimmable	No
Battery	3.2V 1800mAh	4.8V 1800mAh	
Lumens	120 lm	200 lm	
SKU	7210	7211	
Color	6000K	Osram Chip	



LED Panels

LED panels provide versatile lighting solutions for both residential and professional spaces. Available in a wide range of standard sizes, they can be seamlessly integrated into suspended ceilings or installed as stylish hanging lights. With their sleek design and powerful illumination, they combine modern efficiency with a clean, contemporary look.

Features:

- Up to 80% energy savings compared to conventional lighting
- Flexible installation - recessed, surface-mounted, or suspended
- Multiple colour temperature options (warm, neutral, cool)
- Choice of glossy or matte finishes
- Standardized sizes for easy replacement or new projects
- Wide range of wattages to match different needs

Applications:

- Suspended ceilings in offices, schools, and public buildings
- Modern home interiors - kitchens, living rooms, or hallways
- Commercial spaces such as shops, showrooms, and restaurants
- Large indoor areas requiring uniform, glare-free lighting

NEW



LED PANELS -1 Pcs Box

62x62cm -German Standard

Input Voltage	AC175-265V 50/60Hz
Beam Angle	120°
CRI	Ra>80
IP Rating	IP20
Dimmable	No



SKU	Watt	Lumen	Lumen/W	Color	Dimension
2701	36W	3600lm	100lm/W	6000K	620x620x9mm
2702	36W	3600lm	100lm/W	4500K	620x620x9mm
2703	36W	3600lm	100lm/W	2700K	620x620x9mm
2704	36W	3600lm	100lm/W	6000K	620x620x9mm
2705	36W	3600lm	100lm/W	4500K	620x620x9mm
2706	36W	3600lm	100lm/W	2700K	620x620x9mm
2707	36W	3600lm	100lm/W	6000K	620x620x9mm
2708	36W	3600lm	100lm/W	4500K	620x620x9mm
2709	36W	3600lm	100lm/W	2700K	620x620x9mm



LED PANELS -6 Pcs Box

30x120cm

Input Voltage	AC175-265V 50/60Hz
Beam Angle	120°
CRI	Ra>80
IP Rating	IP20
Dimmable	No



SKU	Watt	Lumen	Lumen/W	Color	Dimension
2714	36W	3600lm	100lm/W	6000K	1195x295x10mm
2715	36W	3600lm	100lm/W	4500K	1195x295x10mm
2716	36W	3600lm	100lm/W	2700K	1195x295x10mm
2731	36W	3600lm	100lm/W	6000K	1195x295x10mm
2732	36W	3600lm	100lm/W	4500K	1195x295x10mm
2733	36W	3600lm	100lm/W	2700K	1195x295x10mm

NEW



LED PANELS -6 Pcs Box

60x60cm

Input Voltage	AC175-265V 50/60Hz
Beam Angle	120°
CRI	Ra>80
IP Rating	IP20
Dimmable	No



SKU	Watt	Lumen	Lumen/W	Color	Dimension
2711	36W	3600lm	100lm/W	6000K	595x595x9mm
2712	36W	3600lm	100lm/W	4500K	595x595x9mm
2713	36W	3600lm	100lm/W	2700K	595x595x9mm
2729	36W	3600lm	100lm/W	6000K	595x595x9mm
2730	36W	3600lm	100lm/W	4500K	595x595x9mm
2396	45W	3600lm	80lm/W	2700K	595x595x9mm
2717	36W	3600lm	100lm/W	6000K	595x595x9mm
2718	36W	3600lm	100lm/W	4500K	595x595x9mm
2719	36W	3600lm	100lm/W	2700K	595x595x9mm

NEW



LED FRAME PANELS -2 Pcs Box

60x60cm

Input Voltage	AC220-240V 50/60Hz
Beam Angle	120°
CRI	Ra>80
IP Rating	IP20
Dimmable	No

SKU	Watt	Lumen	Lumen/W	Color	Dimension
2746	36W	3600lm	100lm/W	6000K	595x595x9mm
2747	36W	3600lm	100lm/W	4500K	595x595x9mm

SKU	Watt	Lumen	Lumen/W	Color	Dimension
2748	48W	4800lm	100lm/W	6000K	595x595x9mm
2749	48W	4800lm	100lm/W	4500K	595x595x9mm

LED SPLICING FRAME PANEL -1 Pcs Slim Box NEW

Extremely easy to transport



LED PANELS UGR<19	
62x62cm	
Input Voltage	AC175-265V 50/60Hz
Beam Angle	120°
CRI	Ra>80
IP Rating	IP20
Dimmable	No

SKU	Watt	Lumen	Lumen/W	Color	Dimension
2791	45W	3600lm	100lm/W	6000K	615x615x9mm
2792	45W	3600lm	100lm/W	4500K	615x615x9mm
2793	45W	3600lm	100lm/W	2700K	615x615x9mm

6Pcs Box

2795	45W	3600lm	100lm/W	4500K	615x615x9mm
2796	45W	3600lm	100lm/W	2700K	615x615x9mm



LED PANELS CRI>95	
62x62cm	
Input Voltage	AC175-265V 50/60Hz
Beam Angle	120°
CRI	Ra>95
IP Rating	IP20
Dimmable	No

SKU	Watt	Lumen	Lumen/W	Color	Dimension
2788	45W	3600lm	100lm/W	6000K	615x615x9mm
2789	45W	3600lm	100lm/W	4500K	615x615x9mm
2790	45W	3600lm	100lm/W	2700K	615x615x9mm

6Pcs Box

2797	45W	3600lm	100lm/W	6000K	615x615x9mm
2798	45W	3600lm	100lm/W	4500K	615x615x9mm
2799	45W	3600lm	100lm/W	2700K	615x615x9mm



NEW



LED PANELS CLOUDOPTIC -4 Pcs Box

60x60cm			
Carton Box	4Pcs	CRI	Ra>80
Input Voltage	AC220-240V 50Hz	IP Rating	IP20
Beam Angle	120°	Dimmable	No

SKU	Watt	Lumen	Lumen/W	Color	Dimension
2780	45W	4500lm	100lm/W	6000K	595x595x9mm

LED PANELS HIGH LUMEN

60x60cm			
Carton Box	6Pcs	CRI	Ra>80
Input Voltage	AC220-240V 50Hz	IP Rating	IP20
Beam Angle	120°	Dimmable	No

SKU	Watt	Lumen	Lumen/W	Color	Dimension
2389	29W	3915lm	135lm/W	4500K	595x595x40mm

LED BACKLIT PANELS

30x120cm			
Carton Box	1Pcs	CRI	Ra>80
Input Voltage	AC175-265V 50Hz	IP Rating	IP20
Beam Angle	120°	Dimmable	No

SKU	Watt	Lumen	Lumen/W	Color	Dimension
2385	45W	3600lm	80lm/W	6000K	1195x295x10mm
2387	45W	3600lm	80lm/W	2700K	1195x295x10mm
2377	45W	4500lm	100lm/W	2700K	1195x295x10mm



NEW



LED BACKLIT PANELS - 10 Pcs Box
60x60cm -3CCT

Carton Box	10Pcs	CRI	Ra>80
Input Voltage	AC220-240V 50Hz	IP Rating	IP20
Beam Angle	120°	Dimmable	No

SKU	Watt	Lumen	Lumen/W	Color	Dimension
12779	36W	4320lm	120lm/W	CCT	595x595x33mm



NEW



LED BACKLIT PANELS - 10 Pcs Box
60x60cm -UGR<19

Carton Box	10Pcs	CRI	Ra>80
Input Voltage	AC220-240V 50Hz	IP Rating	IP20
Beam Angle	120°	Dimmable	No

SKU	Watt	Lumen	Lumen/W	Color	Dimension
12777	36W	4320lm	120lm/W	6000K	595x595x34mm
12778	36W	4320lm	120lm/W	4000K	595x595x34mm



LED BACKLIT PANELS - 6 Pcs Box
60x60cm -TP(a) rated glare control diffuser

Carton Box	6Pcs	CRI	Ra>80
Input Voltage	AC220-240V 50Hz	IP Rating	IP20
Beam Angle	120°	Dimmable	No

SKU	Watt	Lumen	Lumen/W	Color	Dimension
2776	30W	3600lm	120lm/W	6000K	595x595x34mm
2777	30W	3600lm	120lm/W	4000K	595x595x34mm

NEW



LED BACKLIT PANELS - 10 Pcs Box
60x60cm

Carton Box	10Pcs	CRI	Ra>80
Input Voltage	AC220-240V 50Hz	IP Rating	IP20
Beam Angle	120°	Dimmable	No

SKU	Watt	Lumen	Lumen/W	Color	Dimension
12771	36W	4320lm	120lm/W	6000K	595x595x36mm
12772	36W	4320lm	120lm/W	4500K	595x595x36mm
12773	36W	4320lm	120lm/W	2700K	595x595x36mm

NEW



LED BACKLIT PANELS - 10 Pcs Box
60x60cm

Carton Box	10Pcs	CRI	Ra>80
Input Voltage	AC220-240V 50Hz	IP Rating	IP20
Beam Angle	120°	Dimmable	No

SKU	Watt	Lumen	Lumen/W	Color	Dimension
2772	40W	3400lm	85lm/W	6000K	595x595x34mm
2773	40W	3400lm	85lm/W	4000K	595x595x34mm

NEW



LED BACKLIT PANELS - 10 Pcs Box
60x60cm

Carton Box	10Pcs	CRI	Ra>80
Input Voltage	AC185-265V 50Hz	IP Rating	IP20
Beam Angle	120°	Dimmable	No

SKU	Watt	Lumen	Lumen/W	Color	Dimension
2770	25W	4000lm	160lm/W	6000K	595x595x34mm
2771	25W	4000lm	160lm/W	4500K	595x595x34mm





NEW

LED BACKLIT PANELS – 6 Pcs Box
120x30cm

Carton Box	6Pcs	CRI	Ra>80
Input Voltage	AC220–240V 50Hz	IP Rating	IP20
Beam Angle	120°	Dimmable	No

SKU	Watt	Lumen	Lumen/W	Color	Dimension
12774	36W	4320lm	120lm/W	6000K	595x595x34mm
12775	36W	4320lm	120lm/W	4500K	595x595x34mm
12776	36W	4320lm	120lm/W	2700K	595x595x34mm



NEW

LED SURFACE/BACKLIT PANELS
60x60cm

Carton Box	10Pcs	CRI	Ra>80
Input Voltage	AC220–240V 50Hz	IP Rating	IP20
Beam Angle	120°	Dimmable	No

SKU	Watt	Lumen	Lumen/W	Colour	Dimension
2784	40W	3600lm	90lm/W	6000K	595x595x40mm
2785	40W	3600lm	90lm/W	4000K	595x595x40mm



NEW

LED SURFACE/BACKLIT PANELS
120x30cm

Carton Box	10Pcs	CRI	Ra>80
Input Voltage	AC220–240V 50Hz	IP Rating	IP20
Beam Angle	120°	Dimmable	No

SKU	Watt	Lumen	Lumen/W	Color	Dimension
2786	40W	3600lm	90lm/W	6000K	1200x300x40mm
2787	40W	3600lm	90lm/W	4000K	1200x300x40mm



EMERGENCY BATTERY PACK
For LED Panels

Battery	3.6V / 4.5Ah	Instant On	0.1s
Input Voltage	AC220–240V 50Hz	Material	Plastic
Size	213x95x45mm	Emergency Duration	3Hours

SKU	6029
Color	White



NEW

LED PANELS
PREMIUM LINE
60x60cm

Carton Box	10Pcs	CRI	Ra>80
Input Voltage	AC175–265V 50Hz	IP Rating	IP20
Beam Angle	120°	Dimmable	No

SKU	Watt	Lumen	Lumen/W	Color	Dimension
2726	40W	4800lm	120lm/W	6000K	595x595x15mm
2727	40W	4800lm	120lm/W	4000K	595x595x15mm
2728	40W	4800lm	120lm/W	2800K	595x595x15mm



LED DALI DRIVER FOR LED PANELS
Adjustable

Power	20–40WW	Output Current	550–1050mA
Input Voltage	AC220–240V 50Hz	Output Voltage	24V–42V
Size	106x70x45mm	Material	Plastic

SKU	6030
Color	White



LED PANEL DRIVER	
Plastic	
Input Voltage	175-265V 50/60Hz
Material	Plastic
IP Rating	IP20
Dimmable	No



SKU	Watt	OutputVoltage	Current	Dimension
6043	36W	DC: 30-40V	900mA	140x45x30mm
6019	36W	DC: 38-42V	900mA	140x45x30mm
6021	45W	DC: 38-42V	950mA	140x45x30 mm
6022	48W	DC: 36-56V	750mA	140x45x30 mm
6031	25W	DC: 30-42V	600mA	140x45x30 mm
6032	36W	DC: 30-42V	900mA	140x45x30 mm
6044	36W	DC: 27-40V	1000mA	140x45x30mm
6028	45W	DC: 30-45V	1000mA	140x45x30mm



DRIVERS FOR LED DOWNLIGHTS	
Plastic Case	
Input Voltage	85-265V 50/60Hz
Material	Plastic
IP Rating	IP20
Dimmable	No

SKU	Watt	OutputVoltage	Current	Dimension
6035	3W	DC: 3-12V	250mA	35x60mm
6036	6W	DC: 15-24V	250mA	35x60mm
6037	12W	DC: 20-40V	300mA	35x60mm
6038	18W	DC: 40-60V	300mA	35x60mm
6039	24W	DC: 60-80V	300mA	35x60mm



FRAMES FOR LED PANELS	
Aluminium /Plastic	

SKU	Aluminium	Aluminium	Aluminium	Alu+Plastic	Alu+Plastic
	5199	5198	5197	15198	15197
Dimension	625x625mm	600x600mm	300x1200mm	600x600mm	300x1200mm

NEW



ACCESSORIES FOR HANGING	
Aluminium	

SKU	5182	5188
Dimension	Stainless Steel Rope	Clips for LED Panels





LED Surface and Mini Panels

LED surface panels provide maximum flexibility in lighting design, allowing easy installation on any hard surface without limitations. Combining modern efficiency with a sleek look, they deliver bright, uniform light while saving energy and reducing maintenance costs. Suitable for both functional and decorative use, they adapt seamlessly to a wider range of indoor environments.

Features:

- Up to 80% lower energy consumption compared to traditional lighting
- Available in multiple colour temperatures (warm, neutral, cool)
- Choice of glossy or matte finishes for different aesthetics
- Offered in standard sizes for easy replacement or new projects
- Wide power range to suit rooms of any scale
- Slim, durable construction with modern design

Applications:

- Homes and apartments
- Offices, shops, and retail spaces
- Hospitals, clinics, and schools
- Restaurants, hotels, and hospitality areas
- Indoor parking, corridors, and utility areas
- Industrial and manufacturing spaces



LED SURFACE PANELS
CCT Light

Input Voltage	85-260V 50/60Hz
Beam Angle	120°
CRI	Ra>80
IP Rating	IP20
Dimmable	No

SKU	Watt	Lumen	Lumen/W	Color	Dimension
12911	6W	420lm	70lm/W	CCT	Φ110x24mm
12912	12W	840lm	70lm/W	CCT	Φ160x24mm
12913	18W	1260lm	70lm/W	CCT	Φ210x24mm
12914	24W	1680lm	70lm/W	CCT	Φ285x24mm

Round

12915	6W	420lm	70lm/W	CCT	110x110x24mm
12916	12W	840lm	70lm/W	CCT	159x159x24mm
12917	18W	1260lm	70lm/W	CCT	209x209x24mm
12918	24W	1680lm	70lm/W	CCT	283x283x24mm

Square



LED CEILING LIGHT
3CCT -Front and Back Light -Plastic

Input Voltage	220-240V 50/60Hz
Beam Angle	120°
CRI	Ra>80
IP Rating	IP65
Dimmable	No

SKU	Watt	Lumen	Lumen/W	Color	Dimension
2938	12W / 4W	1600lm	100lm/W	3CCT	Φ246x47mm
2939	18W / 6W	2400lm	100lm/W	3CCT	Φ296x49mm
2940	24W / 8W	3200lm	100lm/W	3CCT	Φ396x59mm

Black

2935	12W / 4W	1600lm	100lm/W	3CCT	Φ246x47mm
2936	18W / 6W	2400lm	100lm/W	3CCT	Φ296x49mm
2937	25W / 8W	3200lm	100lm/W	3CCT	Φ396x59mm

White



LED SURFACE PANELS
CCT Light

Input Voltage	85-260V 50/60Hz
Beam Angle	120°
CRI	Ra>80
IP Rating	IP20
Dimmable	No

SKU	Watt	Lumen	Lumen/W	Color	Dimension
12929	6W	420lm	70lm/W	CCT	Φ110x24mm
12930	12W	840lm	70lm/W	CCT	Φ160x24mm
12931	18W	1260lm	70lm/W	CCT	Φ210x24mm
12932	24W	1680lm	70lm/W	CCT	Φ285x24mm

Round

12933	6W	420lm	70lm/W	CCT	110x110x24mm
12934	12W	840lm	70lm/W	CCT	159x159x24mm
12935	18W	1260lm	70lm/W	CCT	209x209x24mm
12936	24W	1680lm	70lm/W	CCT	283x283x24mm

Square



LED MULTI-FITPANELS
Power -Selectable /CCT Light

Input Voltage	220-240V 50/60Hz
Beam Angle	120°
CRI	Ra>80
IP Rating	IP24
Dimmable	No

SKU	Watt	Lumen	Lumen/W	Color	Dimension
2598	10W-18W	1000-1800W	100lm/W	CCT	Φ220x18mm
2599	10W-18W	1000-1800W	PIR sensor	CCT	Φ220x18mm

Black

2588	10-18W	1000-1800W	100lm/W	CCT	Φ220x18mm
2589	10-18W	1000-1800W	PIR sensor	CCT	Φ220x18mm

White



LED SURFACE PANELS

Round -White Body

Input Voltage	180-260V 50/60Hz
Beam Angle	120°
CRI	Ra>80
IP Rating	IP20
Dimmable	No

SKU	Watt	Lumen	Lumen/W	Color	Dimension
2231	6W	480lm	80lm/W	6000K	Φ120x31mm
2243	6W	480lm	80lm/W	4500K	Φ120x31mm
2232	6W	480lm	80lm/W	2800K	Φ120x31mm
2244	12W	960lm	80lm/W	6000K	Φ172x31mm
2245	12W	960lm	80lm/W	4500K	Φ172x31mm
2246	12W	960lm	80lm/W	2800K	Φ172x31mm
2235	18W	1440lm	80lm/W	6000K	Φ220x31mm
2247	18W	1440lm	80lm/W	4500K	Φ220x31mm
2236	18W	1440lm	80lm/W	2800K	Φ220x31mm
2248	24W	1920lm	80lm/W	6000K	Φ300x31mm
2249	24W	1920lm	80lm/W	4500K	Φ300x31mm
2250	24W	1920lm	80lm/W	2800K	Φ300x31mm



LED SURFACE PANELS

Round -Home Edition

Input Voltage	85-260V 50/60Hz
Beam Angle	120°
CRI	Ra>80
IP Rating	IP20
Dimmable	No

SKU	Watt	Lumen	Lumen/W	Color	Dimension
2401	6W	480lm	80lm/W	6000K	Φ120x38mm
2402	6W	480lm	80lm/W	4500K	Φ120x38mm
2403	6W	480lm	80lm/W	2800K	Φ120x38mm
2404	12W	960lm	80lm/W	6000K	Φ160x38mm
2405	12W	960lm	80lm/W	4500K	Φ160x38mm
2406	12W	960lm	80lm/W	2800K	Φ160x38mm
2407	18W	1440lm	80lm/W	6000K	Φ220x38mm
2408	18W	1440lm	80lm/W	4500K	Φ220x38mm
2409	18W	1440lm	80lm/W	2800K	Φ220x38mm
2410	24W	1920lm	80lm/W	6000K	Φ300x39mm
2411	24W	1920lm	80lm/W	4500K	Φ300x39mm
2412	24W	1920lm	80lm/W	2800K	Φ300x39mm



LED SURFACE PANELS

Square -White Body

Input Voltage	180-260V 50/60Hz
Beam Angle	120°
CRI	Ra>80
IP Rating	IP20
Dimmable	No

SKU	Watt	Lumen	Lumen/W	Color	Dimension
2237	6W	480lm	80lm/W	6000K	120x120x38mm
2251	6W	480lm	80lm/W	4500K	120x120x38mm
2238	6W	480lm	80lm/W	2800K	120x120x38mm
2252	12W	960lm	80lm/W	6000K	167x167x38mm
2253	12W	960lm	80lm/W	4500K	167x167x38mm
2254	12W	960lm	80lm/W	2800K	167x167x38mm
2241	18W	1440lm	80lm/W	6000K	220x220x38mm
2255	18W	1440lm	80lm/W	4500K	220x220x38mm
2242	18W	1440lm	80lm/W	2800K	220x220x38mm
2256	24W	1920lm	80lm/W	6000K	300x300x39mm
2257	24W	1920lm	80lm/W	4500K	300x300x39mm
2258	24W	1920lm	80lm/W	2800K	300x300x39mm



LED SURFACE PANELS

Square -Home Edition

Input Voltage	85-260V 50/60Hz
Beam Angle	120°
CRI	Ra>80
IP Rating	IP20
Dimmable	No

SKU	Watt	Lumen	Lumen/W	Color	Dimension
2413	6W	480lm	80lm/W	6000K	120x120x38mm
2414	6W	480lm	80lm/W	4500K	120x120x38mm
2415	6W	480lm	80lm/W	2800K	120x120x38mm
2416	12W	960lm	80lm/W	6000K	167x167x38mm
2417	12W	960lm	80lm/W	4500K	167x167x38mm
2418	12W	960lm	80lm/W	2800K	167x167x38mm
2419	18W	1440lm	80lm/W	6000K	220x220x38mm
2420	18W	1440lm	80lm/W	4500K	220x220x38mm
2421	18W	1440lm	80lm/W	2800K	220x220x38mm
2422	24W	1920lm	80lm/W	6000K	300x300x39mm
2423	24W	1920lm	80lm/W	4500K	300x300x39mm
2424	24W	1920lm	80lm/W	2800K	300x300x39mm

NEW



LED BACKLIT SURFACE PANELS

Round -Home Edition -DOB Driver

Input Voltage	85-260V 50/60Hz
Beam Angle	120°
CRI	Ra>80
IP Rating	IP20
Dimmable	No

SKU	Watt	Lumen	Lumen/W	Color	Dimension
2975	6W	360lm	60lm/W	6000K	Φ120x32mm
2976	6W	360lm	60lm/W	4500K	Φ120x32mm
2977	6W	360lm	60lm/W	2700K	Φ120x32mm
2978	12W	840lm	70lm/W	6000K	Φ160x28mm
2979	12W	840lm	70lm/W	4500K	Φ160x28mm
2980	12W	840lm	70lm/W	2700K	Φ160x28mm
2981	18W	1350lm	75lm/W	6000K	Φ210x28mm
2982	18W	1350lm	75lm/W	4500K	Φ210x28mm
2983	18W	1350lm	75lm/W	2700K	Φ210x28mm
2984	24W	1920lm	80lm/W	6000K	Φ280x29mm
2985	24W	1920lm	80lm/W	4500K	Φ280x29mm
2986	24W	1920lm	80lm/W	2700K	Φ280x29mm



LED SURFACE PANELS

CCT Light

Input Voltage	165-260V 50/60Hz
Beam Angle	100°
CRI	Ra>80
IP Rating	IP44
Dimmable	No

	SKU	Watt	Lumen	Lumen/W	Color	Dimension
Round	2535	6W	450lm	75lm/W	CCT	Φ122x35mm
	2536	12W	950lm	80lm/W	CCT	Φ177x35mm
	2537	18W	1450lm	80lm/W	CCT	Φ226x35mm
	2538	24W	2565lm	107lm/W	CCT	Φ245x35mm
Square	2539	6W	450lm	75lm/W	CCT	122x122x35mm
	2540	12W	950lm	80lm/W	CCT	172x172x35mm
	2541	18W	1450lm	80lm/W	CCT	227x227x35mm
	2542	24W	2565lm	107lm/W	CCT	240x240x35mm

NEW



LED BACKLIT SURFACE PANELS

Square -Home Edition -DOB Driver

Input Voltage	85-265V 50/60Hz
Beam Angle	120°
CRI	Ra>80
IP Rating	IP20
Dimmable	No

SKU	Watt	Lumen	Lumen/W	Color	Dimension
2987	6W	360lm	60lm/W	6000K	120x120x32mm
2988	6W	360lm	60lm/W	4500K	120x120x32mm
2989	6W	360lm	60lm/W	2700K	120x120x32mm
2990	12W	840lm	70lm/W	6000K	160x160x28mm
2991	12W	840lm	70lm/W	4500K	160x160x28mm
2992	12W	840lm	70lm/W	2700K	160x160x28mm
2993	18W	1350lm	75lm/W	6000K	210x210x28mm
2994	18W	1350lm	75lm/W	4500K	210x210x28mm
2995	18W	1350lm	75lm/W	2700K	210x210x28mm
2996	24W	1920lm	80lm/W	6000K	280x280x29mm
2997	24W	1920lm	80lm/W	4500K	280x280x29mm
2998	24W	1920lm	80lm/W	2700K	280x280x29mm



LED SURFACE PANELS

CCT Light

Input Voltage	165-260V 50/60Hz
Beam Angle	100°
CRI	Ra>80
IP Rating	IP44
Dimmable	No

	SKU	Watt	Lumen	Lumen/W	Color	Dimension
Round	2590	6W	450lm	75lm/W	CCT	Φ115x32mm
	2591	12W	950lm	80lm/W	CCT	Φ170x32mm
	2592	18W	1450lm	80lm/W	CCT	Φ220x32mm
	2593	24W	2150lm	90lm/W	CCT	Φ240x32mm
Square	2594	6W	450lm	75lm/W	CCT	115x115x32mm
	2595	12W	950lm	80lm/W	CCT	165x165x32mm
	2596	18W	1450lm	80lm/W	CCT	220x220x32mm
	2597	24W	2150lm	90lm/W	CCT	224x224x32mm



LED SURFACE PANELS	
CCT Light	
Input Voltage	85-265V 50/60Hz
Beam Angle	120°
CRI	Ra>80
IP Rating	IP20
Dimmable	No

	SKU	Watt	Lumen	Cut Size	Color	Dimension
Round	12901	3W	210lm	Φ65mm	CCT	Φ83x14mm
	12902	6W	420lm	Φ100mm	CCT	Φ119x14mm
	12903	12W	840lm	Φ150mm	CCT	Φ168x14mm
	12904	18W	1260lm	Φ200mm	CCT	Φ220x14mm
	12905	24W	1680lm	Φ275mm	CCT	Φ295x14mm
Square	12906	3W	210lm	70x70mm	CCT	90x90x21mm
	12907	6W	420lm	100x100mm	CCT	119x119x15mm
	12908	12W	840lm	150x150mm	CCT	170x170x15mm
	12909	18W	1260lm	200x200mm	CCT	219x219x15mm
	12910	24W	1680lm	275x275mm	CCT	297x297x15mm



LEDFRAMELESS MINI PANELS	
CCT Light	
Input Voltage	220-240V 50/60Hz
Beam Angle	180°
CRI	Ra>80
IP Rating	IP20
Dimmable	No

SKU	Watt	Lumen	Lumen/W	Color	Dimension
12601	9W	900lm	100lm/W	CCT	Φ100x21mm
Multifit Cut Size ::Φ46-78mm					
12602	18W	1800lm	100lm/W	CCT	Φ119x21mm
Multifit Cut Size ::Φ46-98mm					
12603	24W	2400lm	100lm/W	CCT	Φ162x21mm
Multifit Cut Size ::Φ46-143mm					
12604	36W	3600lm	100lm/W	CCT	Φ221x21mm
Multifit Cut Size ::Φ46-200mm					



LED SURFACE PANELS	
CCT Light	
Input Voltage	85-265V 50/60Hz
Beam Angle	120°
CRI	Ra>80
IP Rating	IP20
Dimmable	No

	SKU	Watt	Lumen	Cut Size	Color	Dimension
Round	12921	3W	210lm	Φ65mm	CCT	Φ83x14mm
	12922	6W	420lm	Φ100mm	CCT	Φ119x14mm
	12923	12W	840lm	Φ150mm	CCT	Φ168x14mm
	12924	18W	1260lm	Φ200mm	CCT	Φ220x14mm
Square	12925	3W	210lm	70x70mm	CCT	90x90x21mm
	12926	6W	420lm	100x100mm	CCT	119x119x15mm
	12927	12W	840lm	150x150mm	CCT	170x170x15mm
	12928	18W	1260lm	200x200mm	CCT	219x219x15mm





LED BUILT-INMODULE

Round -with Driver

Input Voltage	85-260V 50/60Hz
Beam Angle	120°
CRI	Ra>80
IP Rating	IP20
Dimmable	No

SKU	Watt	Lumen	Cut Size	Color	Dimension
2431	3W	150lm	Φ65mm	6000K	Φ88x19mm
2432	3W	150lm	Φ65mm	4500K	Φ88x19mm
2433	3W	150lm	Φ65mm	2800K	Φ88x19mm
2434	6W	360lm	Φ100mm	6000K	Φ118x19mm
2435	6W	360lm	Φ100mm	4500K	Φ118x19mm
2436	6W	360lm	Φ100mm	2800K	Φ118x19mm
2437	12W	840lm	Φ150mm	6000K	Φ170x19mm
2438	12W	840lm	Φ150mm	4500K	Φ170x19mm
2439	12W	840lm	Φ150mm	2800K	Φ170x19mm
2335	18W	1350lm	Φ200mm	6000K	Φ225x19mm
2440	18W	1350lm	Φ200mm	4500K	Φ225x19mm
2336	18W	1350lm	Φ200mm	2800K	Φ225x19mm
2441	24W	1700lm	Φ250mm	6000K	Φ300x19mm
2442	24W	1700lm	Φ250mm	4500K	Φ300x19mm
2443	24W	1700lm	Φ250mm	2800K	Φ300x19mm



LED BUILT-INMODULE

Round -Home Edition

Input Voltage	175-260V 50/60Hz
Beam Angle	120°
CRI	Ra>80
IP Rating	IP20
Dimmable	No

SKU	Watt	Lumen	Cut Size	Color	Dimension
2470	3W	150lm	Φ65mm	6000K	Φ83x14mm
2471	3W	150lm	Φ65mm	4500K	Φ83x14mm
2472	3W	150lm	Φ65mm	2800K	Φ83x14mm
2473	6W	360lm	Φ100mm	6000K	Φ118x19mm
2474	6W	360lm	Φ100mm	4500K	Φ118x19mm
2475	6W	360lm	Φ100mm	2800K	Φ118x19mm
2476	12W	840lm	Φ150mm	6000K	Φ170x23mm
2477	12W	840lm	Φ150mm	4500K	Φ170x23mm
2478	12W	840lm	Φ150mm	2800K	Φ170x23mm
2479	18W	1350lm	Φ200mm	6000K	Φ225x23mm
2480	18W	1350lm	Φ200mm	4500K	Φ225x23mm
2481	18W	1350lm	Φ200mm	2800K	Φ225x23mm
2482	24W	1700lm	Φ250mm	6000K	Φ297x15mm
2483	24W	1700lm	Φ250mm	4500K	Φ297x15mm
2484	24W	1700lm	Φ250mm	2800K	Φ297x15mm



LED BUILT-INMODULE

Square -with Driver

Input Voltage	85-260V 50/60Hz
Beam Angle	120°
CRI	Ra>80
IP Rating	IP20
Dimmable	No

SKU	Watt	Lumen	Sut Size	Color	Dimension
2444	3W	150lm	70x70mm	6000K	85x85x19mm
2445	3W	150lm	70x70mm	4500K	85x85x19mm
2446	3W	150lm	70x70mm	2800K	85x85x19mm
2447	6W	360lm	100x100mm	6000K	120x120x22mm
2448	6W	360lm	100x100mm	4500K	120x120x22mm
2449	6W	360lm	100x100mm	2800K	120x120x22mm
2450	12W	840lm	150x150mm	6000K	166x166x19mm
2451	12W	840lm	150x150mm	4500K	166x166x19mm
2452	12W	840lm	150x150mm	2800K	166x166x19mm
2348	18W	1350lm	200x200mm	6000K	225x225x20mm
2453	18W	1350lm	200x200mm	4500K	225x225x20mm
2349	18W	1350lm	200x200mm	2800K	225x225x20mm
2454	24W	1700lm	250x250mm	6000K	293x293x25mm
2455	24W	1700lm	250x250mm	4500K	293x293x25mm
2456	24W	1700lm	250x250mm	2800K	293x293x25mm



LED BUILT-INMODULE

Square -Home Edition

Input Voltage	85-260V 50/60Hz
Beam Angle	120°
CRI	Ra>80
IP Rating	IP20
Dimmable	No

SKU	Watt	Lumen	Lumen/W	Color	Dimension
2485	3W	150lm	70x70mm	6000K	85x85x19mm
2486	3W	150lm	70x70mm	4500K	85x85x19mm
2487	3W	150lm	70x70mm	2800K	85x85x19mm
2488	6W	360lm	100x100mm	6000K	119x119x20mm
2489	6W	360lm	100x100mm	4500K	119x119x20mm
2490	6W	360lm	100x100mm	2800K	119x119x20mm
2491	12W	840lm	150x150mm	6000K	166x166x19mm
2492	12W	840lm	150x150mm	4500K	166x166x19mm
2493	12W	840lm	150x150mm	2800K	166x166x19mm
2494	18W	1350lm	200x200mm	6000K	219x219x19mm
2496	18W	1350lm	200x200mm	4500K	219x219x19mm
2495	18W	1350lm	200x200mm	2800K	219x219x19mm
2497	24W	1700lm	250x250mm	6000K	297x297x19mm
2498	24W	1700lm	250x250mm	4500K	297x297x19mm
2499	24W	1700lm	250x250mm	2800K	297x297x19mm

NEW



LED BACKLIT BUILT-INMODULE	
Round -Home Edition -DOB Driver	
Input Voltage	85-260V 50/60Hz
Beam Angle	120°
CRI	Ra>80
IP Rating	IP20
Dimmable	No

SKU	Watt	Lumen	Lumen/W	Color	Dimension
2951	6W	360lm	60lm/W	6000K	Φ120x24mm
2952	6W	360lm	60lm/W	4500K	Φ120x24mm
2953	6W	360lm	60lm/W	2700K	Φ120x24mm
2954	12W	840lm	70lm/W	6000K	Φ170x24mm
2955	12W	840lm	70lm/W	4500K	Φ170x24mm
2956	12W	840lm	70lm/W	2700K	Φ170x24mm
2957	18W	1350lm	75lm/W	6000K	Φ225x24mm
2958	18W	1350lm	75lm/W	4500K	Φ225x24mm
2959	18W	1350lm	75lm/W	2700K	Φ225x24mm
2960	24W	1920lm	80lm/W	6000K	Φ300x27mm
2961	24W	1920lm	80lm/W	4500K	Φ300x27mm
2962	24W	1920lm	80lm/W	2700K	Φ300x27mm



SKU	Surface AdapterKit For
5003	Compatable with SKU: 2581;2582
5004	Compatable with SKU: 2583
5005	Compatable with SKU: 2584
5006	Compatable with SKU: 2585

LED BUILT-IN/SURFACE MODULE	
CCT Light -Dimmable	
Input Voltage	220-240V 50/60Hz
Beam Angle	100°
CRI	Ra>80
IP Rating	IP44
Dimmable	YES



SKU	Watt	Lumen	Lumen/W	Color	Dimension
2581	6W	450lm	75lm/W	CCT	Φ115x32mm
2582	9W	650lm	72lm/W	CCT	Φ115x32mm
2583	12W	900lm	75lm/W	CCT	Φ170x32mm
2584	20W	1600lm	80lm/W	CCT	Φ220x32mm
2585	24W	2100lm	88lm/W	CCT	Φ240x32mm

NEW



LED BACKLIT BUILT-INMODULE	
Square -Home Edition -DOB Driver	
Input Voltage	85-265V 50/60Hz
Beam Angle	120°
CRI	Ra>80
IP Rating	IP20
Dimmable	No

SKU	Watt	Lumen	Lumen/W	Color	Dimension
2963	6W	360lm	60lm/W	6000K	120x120x24mm
2964	6W	360lm	60lm/W	4500K	120x120x24mm
2965	6W	360lm	60lm/W	2700K	120x120x24mm
2966	12W	840lm	70lm/W	6000K	170x170x24mm
2967	12W	840lm	70lm/W	4500K	170x170x24mm
2968	12W	840lm	70lm/W	2700K	170x170x24mm
2969	18W	1350lm	75lm/W	6000K	225x225x24mm
2970	18W	1350lm	75lm/W	4500K	225x225x24mm
2971	18W	1350lm	75lm/W	2700K	225x225x24mm
2972	24W	1920lm	80lm/W	6000K	300x300x27mm
2973	24W	1920lm	80lm/W	4500K	300x300x27mm
2974	24W	1920lm	80lm/W	2700K	300x300x27mm



SKU	Mini Panels DimmableDrivers
6009	Driver 7-12*1W 0-10V
6025	Driver 5-9*1W 300mA
6026	Driver 10-18*1W 300mA
6027	Driver 20-30*1W 300mA

LED BUILT-IN/SURFACE MODULE	
CCT Light	
Input Voltage	175-265V 50/60Hz
Beam Angle	100°
CRI	Ra>80
IP Rating	IP20
Dimmable	No



SKU	Watt	Lumen	Lumen/W	Color	Dimension
2586	18W	1600lm	89lm/W	CCT	Φ225x19mm
2587	30W	3000lm	100lm/W	CCT	Φ330x19mm



LED Ceiling Lights

LED ceiling lights are a versatile and stylish choice for modern interiors, available in a wide range of shapes, sizes, and finishes to complement any room. Built with high-quality fittings, they combine energy efficiency with reliable performance, making them suitable for everything from elegant living spaces to practical office environments.

Features:

- Save up to 80% energy compared to conventional lighting
- Multiple colour temperature options (warm to cool)
- Choice of glossy or matte finishes
- Offered in standard sizes for easy integration
- Range of power outputs to suit different room sizes
- Long lifespan with low maintenance

Applications:

- Suspended and standard ceilings
- Residential spaces - living rooms, kitchens, bedrooms
- Offices, meeting rooms, and workspaces
- Ideal for large indoor areas such as halls or lobbies



SKU 2931
Color CCT



LED CEILING LIGHT			
36x2W -CCT -Remote Control			
Power	36x2W	Beam Angle	120°
Input Voltage	AC175-260V 50Hz	CRI	Ra>80
Lumens	5400lm	IP Rating	IP20
Size	ø500x50mm	Dimmable	Yes



NEW



SKU 19007
Color CCT



LED CEILING LAMP			
30W -CCT -Remote Control			
Power	30W	Beam Angle	180°
Input Voltage	AC220-240V 50Hz	CRI	Ra>80
Lumens	2940lm	IP Rating	IP20
Size	440x290x120mm	Dimmable	Yes

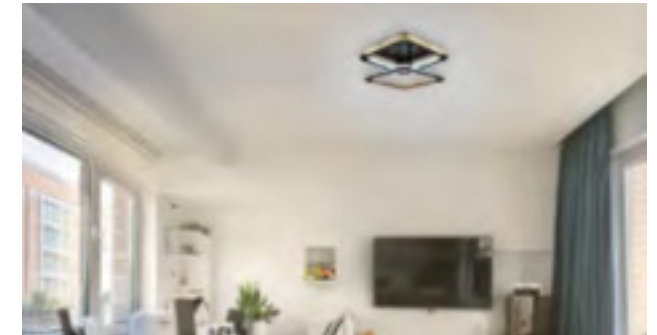

SKU 2930
Color CCT



LED CEILING LIGHT			
48x2W -CCT -Remote Control			
Power	48x2W	Beam Angle	120°
Input Voltage	AC175-260V 50Hz	CRI	Ra>80
Lumens	7200lm	IP Rating	IP20
Size	ø500x50mm	Dimmable	Yes



NEW



SKU 19008
Color CCT



LED CEILING LAMP			
45W -CCT -Remote Control			
Power	45W	Beam Angle	180°
Input Voltage	AC220-240V 50Hz	CRI	Ra>80
Lumens	4020lm	IP Rating	IP20
Size	620x290x120mm	Dimmable	Yes

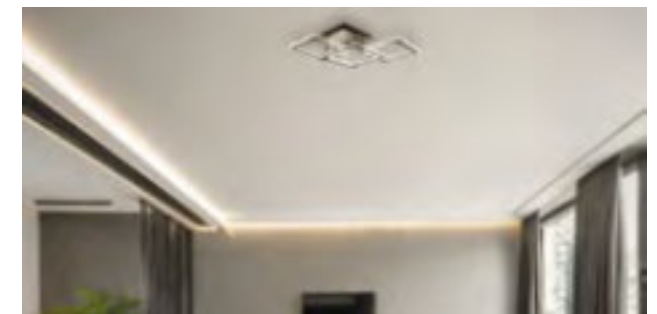

SKU 2929
Color CCT



LED CEILING LIGHT			
60x2W -CCT -Remote Control			
Power	60x2W	Beam Angle	120°
Input Voltage	AC220-240V 50Hz	CRI	Ra>80
Lumens	9000lm	IP Rating	IP20
Size	500x500x50mm	Dimmable	Yes

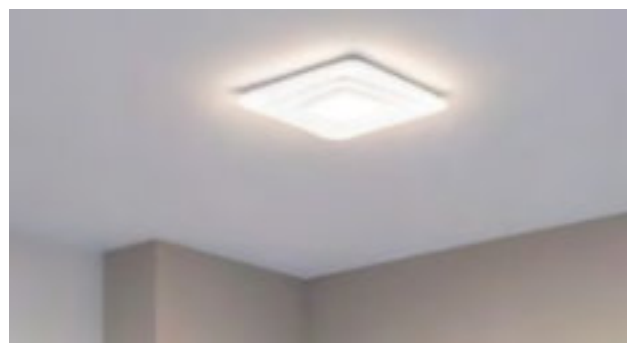

NEW



SKU 19009
Color CCT



LED CEILING LAMP			
50W -CCT -Remote Control			
Power	50W	Beam Angle	180°
Input Voltage	AC220-240V 50Hz	CRI	Ra>80
Lumens	4580lm	IP Rating	IP20
Size	650x470x85mm	Dimmable	Yes

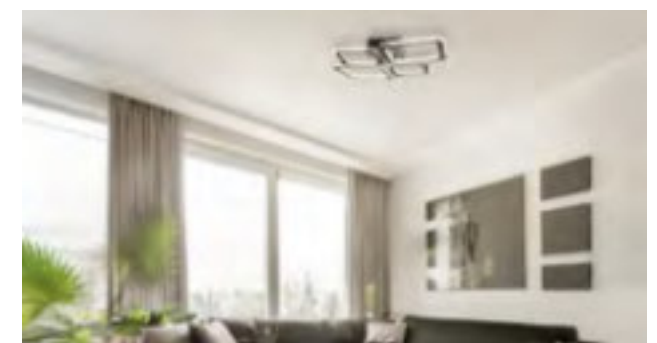

NEW

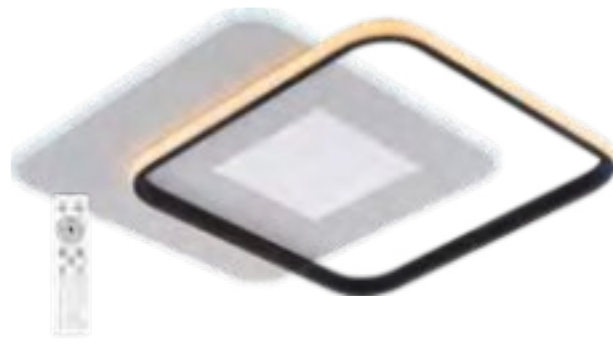

LED CEILING LAMP			
60W -CCT -Remote Control			
Power	60W	Beam Angle	180°
Input Voltage	AC220-240V 50Hz	CRI	Ra>80
Lumens	4800lm	IP Rating	IP20
Size	455x455x50mm	Dimmable	Yes



SKU 19010
Color CCT



NEW

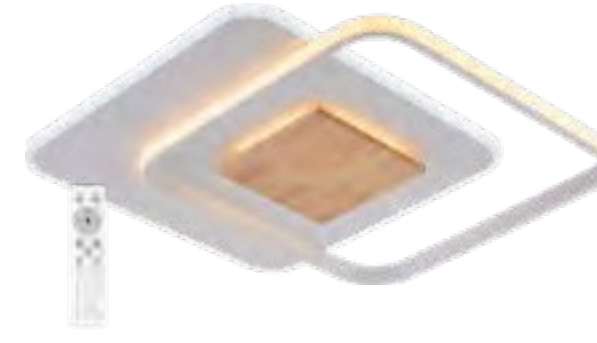

LED CEILING LAMP			
60W -CCT -Remote Control			
Power	60W	Beam Angle	180°
Input Voltage	AC220-240V 50Hz	CRI	Ra>80
Lumens	5180lm	IP Rating	IP20
Size	450x450x45mm	Dimmable	Yes



SKU 19013
Color CCT



NEW



LED CEILING LAMP			
54W -CCT -Remote Control			
Power	54W	Beam Angle	180°
Input Voltage	AC220-240V 50Hz	CRI	Ra>80
Lumens	4120lm	IP Rating	IP20
Size	460x370x45mm	Dimmable	Yes



SKU 19011
Color CCT



NEW



LED CEILING LAMP			
54W -CCT -Remote Control			
Power	54W	Beam Angle	180°
Input Voltage	AC220-240V 50Hz	CRI	Ra>80
Lumens	4120lm	IP Rating	IP20
Size	460x370x45mm	Dimmable	Yes



SKU 19012
Color CCT



NEW



LED CEILING LAMP			
16W -CCT			
Power	16W	Beam Angle	180°
Input Voltage	AC220-240V 50Hz	CRI	Ra>80
Lumens	1480lm	IP Rating	IP20
Size	Φ175x45.5mm	Dimmable	No



SKU 19016
Color 3000K -6000K



NEW



LED CEILING LAMP			
23W -CCT			
Power	23W	Beam Angle	180°
Input Voltage	AC220-240V 50Hz	CRI	Ra>80
Lumens	2080lm	IP Rating	IP20
Size	195x195x45mm	Dimmable	No

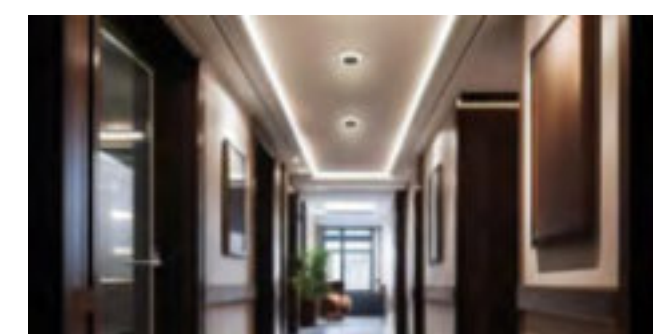

SKU 19015
Color 3000K -6000K



NEW



LED CEILING LAMP			
42W -CCT -Remote Control			
Power	42W	Beam Angle	180°
Input Voltage	AC220-240V 50Hz	CRI	Ra>80
Lumens	2340lm	IP Rating	IP20
Size	Φ400x100 mm	Dimmable	No



SKU 19014
Color CCT



NEW



LED CEILING LAMP			
106W			
Power	106W	Beam Angle	180°
Input Voltage	AC175-265V 50Hz	CRI	Ra>80
Lumens	8460lm	IP Rating	IP20
Size	900x600x50mm	Dimmable	No



SKU 19063
Color 3000K



NEW



LED CEILING LAMP			
50W			
Power	50W	Beam Angle	180°
Input Voltage	AC175-265V 50Hz	CRI	Ra>80
Lumens	560lm	IP Rating	IP20
Size	Φ830mm	Dimmable	No



SKU 19053
Color 3000K



NEW



LED CEILING LAMP			
7W			
Power	7W	Beam Angle	180°
Input Voltage	AC175-265V 50Hz	CRI	Ra>80
Lumens	560lm	IP Rating	IP20
Size	Φ200mm	Dimmable	No



SKU 19073
Color 3000K



NEW

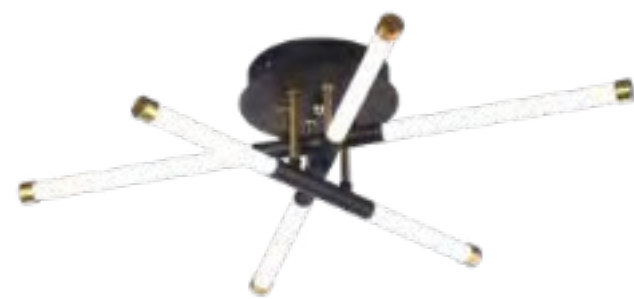

LED CEILING LAMP			
15W			
Power	15W	Beam Angle	180°
Input Voltage	AC175-265V 50Hz	CRI	Ra>80
Lumens	1200lm	IP Rating	IP20
Size	Φ700mm	Dimmable	No

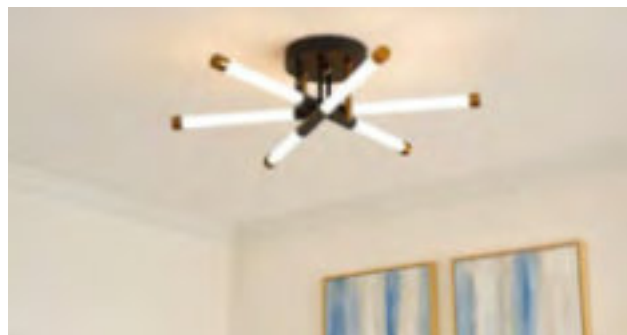

SKU 19070
Color 3000K



NEW



LED CEILING LAMP			
13W			
Power	13W	Beam Angle	180°
Input Voltage	AC175-265V 50Hz	CRI	Ra>80
Lumens	1040lm	IP Rating	IP20
Size	240x200x125mm	Dimmable	No



SKU 19072
Color 3000K



NEW



SKU 12823
Color CCT



LED CEILING LAMP			
86W -CCT -Remote Control			
Power	86W	Beam Angle	120°
Input Voltage	AC180-265V 50Hz	CRI	Ra>80
Lumens	6450lm	IP Rating	IP20
Size	900x300x120mm	Dimmable	Yes



NEW



SKU 12831
Color CCT



LED CEILING LAMP			
78W -CCT -Remote Control			
Power	78W	Beam Angle	120°
Input Voltage	AC180-265V 50Hz	CRI	Ra>80
Lumens	5850lm	IP Rating	IP20
Size	φ480x60mm	Dimmable	Yes



NEW



SKU 12821
Color CCT



LED CEILING LAMP			
44W -CCT -Remote Control			
Power	44W	Beam Angle	120°
Input Voltage	AC180-265V 50Hz	CRI	Ra>80
Lumens	3300lm	IP Rating	IP20
Size	430x300x110mm	Dimmable	Yes



NEW



SKU 12833
Color CCT



LED CEILING LAMP			
84W -CCT -Remote Control			
Power	84W	Beam Angle	120°
Input Voltage	AC180-265V 50Hz	CRI	Ra>80
Lumens	6300lm	IP Rating	IP20
Size	560x410x60mm	Dimmable	Yes



NEW



SKU 12822
Color CCT



LED CEILING LAMP			
46W -CCT -Remote Control			
Power	46W	Beam Angle	120°
Input Voltage	AC180-265V 50Hz	CRI	Ra>80
Lumens	3450lm	IP Rating	IP20
Size	430x400x100mm	Dimmable	Yes



NEW



SKU 12832
Color CCT



LED CEILING LAMP			
88W -CCT -Remote Control			
Power	88W	Beam Angle	120°
Input Voltage	AC180-265V 50Hz	CRI	Ra>80
Lumens	6600lm	IP Rating	IP20
Size	φ480x60mm	Dimmable	Yes



NEW



LED CEILING LAMP			
84W -CCT -Remote Control			
Power	84W	Beam Angle	120°
Input Voltage	AC180-265V 50Hz	CRI	Ra>80
Lumens	6300lm	IP Rating	IP20
Size	480x60mm	Dimmable	Yes

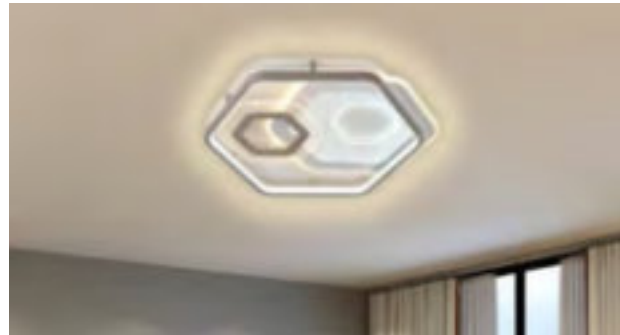

SKU	12828
Color	CCT



NEW



LED CEILING LAMP			
64W -CCT -Remote Control			
Power	64W	Beam Angle	120°
Input Voltage	AC180-265V 50Hz	CRI	Ra>80
Lumens	4800lm	IP Rating	IP20
Size	Φ480x60 mm	Dimmable	Yes



SKU	12825
Color	CCT



NEW



LED CEILING LAMP			
68W -CCT -Remote Control			
Power	68W	Beam Angle	120°
Input Voltage	AC180-265V 50Hz	CRI	Ra>80
Lumens	5100lm	IP Rating	IP20
Size	Φ480x60mm	Dimmable	Yes



SKU	12827
Color	CCT



NEW



LED CEILING LAMP			
68W -CCT -Remote Control			
Power	68W	Beam Angle	120°
Input Voltage	AC180-265V 50Hz	CRI	Ra>80
Lumens	5100lm	IP Rating	IP20
Size	Φ500mm	Dimmable	Yes



SKU	12824
Color	CCT



NEW



LED CEILING LAMP			
128W -CCT -Remote Control			
Power	128W	Beam Angle	120°
Input Voltage	AC180-265V 50Hz	CRI	Ra>80
Lumens	9600lm	IP Rating	IP20
Size	480x480x65mm	Dimmable	Yes



SKU	12826
Color	CCT



NEW

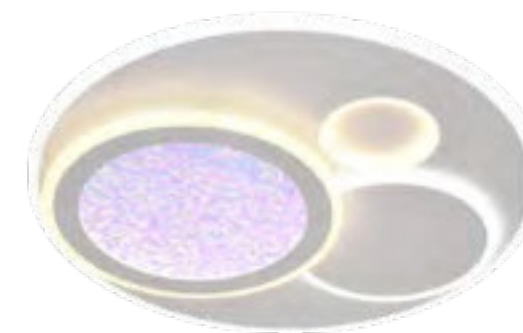

LED CEILING LAMP			
84W -CCT -Remote Control			
Power	84W	Beam Angle	120°
Input Voltage	AC180-265V 50Hz	CRI	Ra>80
Lumens	6300lm	IP Rating	IP20
Size	Φ480x60mm	Dimmable	Yes



SKU	12834
Color	CCT



NEW



LED CEILING LAMP			
78W -CCT -Remote Control			
Power	78W	Beam Angle	120°
Input Voltage	AC180-265V 50Hz	CRI	Ra>80
Lumens	5850lm	IP Rating	IP20
Size	480x480x60mm	Dimmable	Yes



SKU	12829
Color	CCT



NEW



LED CEILING LAMP			
36W -CCT Switch			
Power	36W	Beam Angle	120°
Input Voltage	AC220-240V 50Hz	CRI	Ra>80
Lumens	2700lm	IP Rating	IP20
Size	Φ485x65mm	Dimmable	No



SKU	12802	12803
Body	Black	Silver



NEW

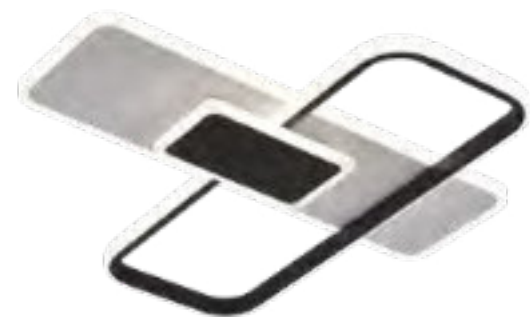

LED CEILING LAMP			
68W -CCT -Remote Control			
Power	68W	Beam Angle	120°
Input Voltage	AC180-265V 50Hz	CRI	Ra>80
Lumens	5100lm	IP Rating	IP20
Size	600x200mm	Dimmable	Yes



SKU	12830
Color	CCT



NEW



LED CEILING LAMP			
36W -CCT Switch			
Power	36W	Beam Angle	120°
Input Voltage	AC220-240V 50Hz	CRI	Ra>80
Lumens	2700lm	IP Rating	IP20
Size	Φ515x80mm	Dimmable	No



SKU	12804	12805	12806	12807
Body	Grey	Taupe	Red Velvet	Indigo



NEW



LED CEILING LAMP			
12W -CCT Switch			
Power	12W	Beam Angle	120°
Input Voltage	AC220-240V 50Hz	CRI	Ra>80
Lumens	900lm	IP Rating	IP20
Size	Φ293x65mm	Dimmable	No



SKU	12801
Body	Silver



NEW



LED CEILING LAMP			
24W -CCT Switch			
Power	24W	Beam Angle	120°
Input Voltage	AC220-240V 50Hz	CRI	Ra>80
Lumens	1800lm	IP Rating	IP20
Size	Φ510x115mm	Dimmable	No

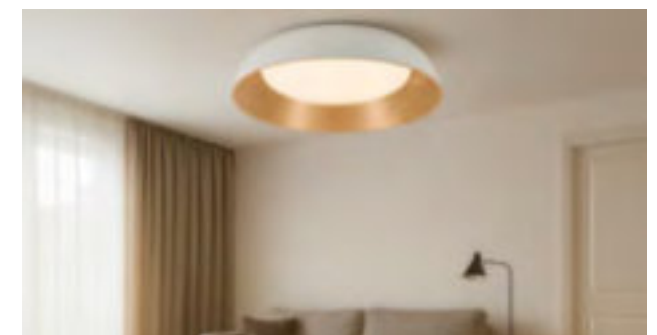

SKU	12812	12811
Body	Black	White



NEW



LED CEILING LAMP			
12W -CCT Switch			
Power	12W	Beam Angle	120°
Input Voltage	AC220-240V 50Hz	CRI	Ra>80
Lumens	900lm	IP Rating	IP20
Size	Φ330x100mm	Dimmable	No



SKU	12810
Body	Cyan



NEW



LED CEILING LAMP			
48W -CCT -Remote Control			
Power	48W	Beam Angle	120°
Input Voltage	AC220-240V 50Hz	CRI	Ra>80
Lumens	3600lm	IP Rating	IP20
Size	Φ395x60mm	Dimmable	Yes



SKU	12813	12814
Body	Black	White



NEW



LED CEILING LAMP			
24W -CCT Switch			
Power	24W	Beam Angle	120°
Input Voltage	AC220-240V 50Hz	CRI	Ra>80
Lumens	1800lm	IP Rating	IP20
Size	Φ440x110mm	Dimmable	No



SKU	12809
Body	Reseda



NEW



LED CEILING LAMP			
60W -CCT -Remote Control			
Power	60W	Beam Angle	120°
Input Voltage	AC220-240V 50Hz	CRI	Ra>80
Lumens	4500lm	IP Rating	IP20
Size	Φ510x85mm	Dimmable	Yes

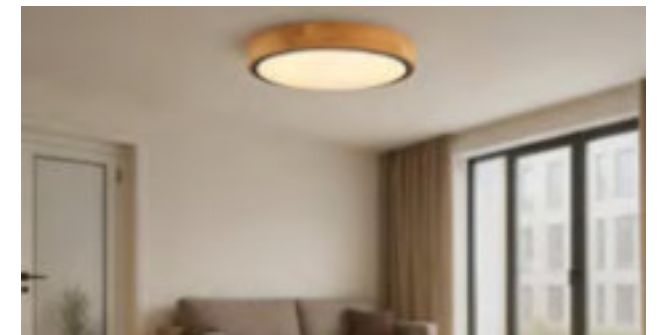

SKU	12815
Body	Oak Wood



NEW



LED CEILING LAMP			
36W -CCT Switch			
Power	36W	Beam Angle	120°
Input Voltage	AC220-240V 50Hz	CRI	Ra>80
Lumens	2700lm	IP Rating	IP20
Size	Φ555x115mm	Dimmable	No



SKU	12808
Body	White





LED CEILING LIGHT
CCT Light -RGB Ring -Remote Control

Input Voltage	85-260V 50/60Hz
Beam Angle	120°
CRI	Ra>80
IP Rating	IP20
Dimmable	YES

	SKU	Watt	Lumen	Lumen/W	Color	Dimension
Black	2941	18W	1440lm	80lm/W	CCT	φ293x26mm
	2942	24W	1920lm	80lm/W	CCT	φ420x26mm
	2943	32W	2565lm	80lm/W	CCT	φ540x30mm
White	2944	18W	1440lm	80lm/W	CCT	φ293x26mm
	2945	24W	1920lm	80lm/W	CCT	φ420x26mm
	2946	32W	2565lm	80lm/W	CCT	φ540x30mm



LED CEILING LIGHT
Outdoor -CCT Light

Input Voltage	220-240V 50/60Hz
Beam Angle	120°
CRI	Ra>80
IP Rating	IP65
Dimmable	No

	SKU	Watt	Lumen	Lumen/W	Color	Dimension
Black	2823	20W	2000lm	10lm/W	CCT	φ202x51mm
	2824	30W	3000lm	100lm/W	CCT	φ302x55mm
	2827	20W	2000lm		CCT	φ202x51mm
	2828	30W	3000lm		CCT	φ302x55mm
White	2821	20W	2000lm	95lm/W	CCT	φ202x51mm
	2822	30W	3000lm	100lm/W	CCT	φ302x55mm
	2825	20W	2000lm		CCT	φ202x51mm
	2826	30W	3000lm		CCT	φ302x55mm



LED CEILING LIGHT
CCT Light -Switch

Input Voltage	220-240V 50/60Hz
Beam Angle	120°
CRI	Ra>80
IP Rating	IP54
Dimmable	No

	SKU	Watt	Lumen	Lumen/W	Color	Dimension
Round	2501	18W	1880lm	104lm/W	CCT	φ220x51mm
	2502	24W	2565lm	107lm/W	CCT	φ280x51mm
	2505	18W	1880lm		CCT	φ220x51mm
Square	2503	18W	1880lm	104lm/W	CCT	φ220x51mm
	2504	24W	2565lm	107lm/W	CCT	φ280x51mm
	2506	18W	1880lm		CCT	φ220x51mm



LED CEILING LIGHT
CCT Light +DIP Switch

Input Voltage	220-240V 50/60Hz
Beam Angle	120°
CRI	Ra>80
IP Rating	IP20
Dimmable	No

	SKU	Watt	Lumen	Lumen/W	Color	Dimension
Matt White	2831	12W	880lm	74lm/W	CCT	φ260x60mm
	2833	18W	1550lm	86lm/W	CCT	φ335x60mm
	2835	24W	1990lm	83lm/W	CCT	φ385x60mm
Dotty Sparkle	2832	12W	880lm	74lm/W	CCT	φ260x60mm
	2834	18W	1550lm	86lm/W	CCT	φ335x60mm
	2836	24W	1990lm	83lm/W	CCT	φ385x60mm

NEW



LED CEILING LIGHT

CCT Light

Input Voltage	220-240V 50/60Hz
Beam Angle	120°
CRI	Ra>80
IP Rating	IP44
Dimmable	No

SKU	Watt	Lumen	Lumen/W	Color	Dimension
2947	12W	1200lm	100lm/W	CCT	Φ230x45mm
2948	18W	1800lm	100lm/W	CCT	Φ280x45mm
2949	24W	2400lm	100lm/W	CCT	Φ380x59mm
2950	36W	3600lm	100lm/W	CCT	Φ380x59mm

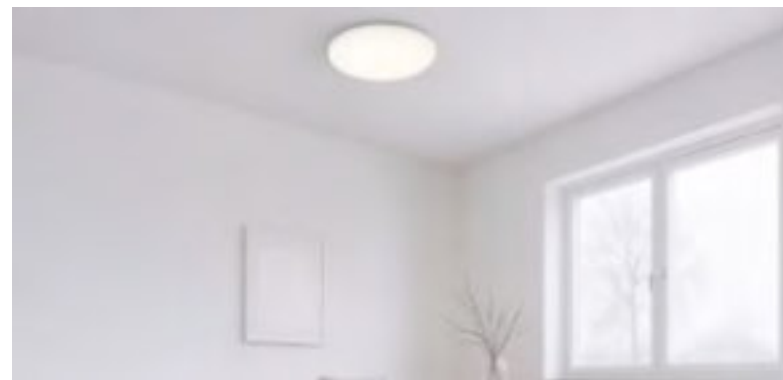

LED CEILING LIGHTS

City Line -Matt White

Input Voltage	175-265V 50/60Hz
Beam Angle	120°
CRI	Ra>80
IP Rating	IP20
Dimmable	No

SKU	Watt	Lumen	Lumen/W	Color	Dimension
2840	12W	880lm	73lm/W	6000K	Φ230x65mm
2841	12W	880lm	73lm/W	4500K	Φ230x65mm
2842	12W	880lm	73lm/W	3000K	Φ230x65mm
2843	18W	1550lm	86lm/W	6000K	Φ300x65mm
2844	18W	1550lm	86m/W	4500K	Φ300x65mm
2845	18W	1550lm	86lm/W	3000K	Φ300x65mm
2846	24W	1990lm	83lm/W	6000K	Φ350x65mm
2847	24W	1990lm	83lm/W	4500K	Φ350x65mm
2848	24W	1990lm	83lm/W	3000K	Φ350x65mm

NEW



LED COB DOWNLIGHT

Aluminium

Input Voltage	85-265V 50/60Hz
Beam Angle	120°
CRI	Ra>80
IP Rating	IP20
Dimmable	No

	SKU	Watt	Lumen	Lumen/W	Color	Dimension
Black	12037	7W	700lm	100lm/W	4000K	Φ75x72mm
	12038	7W	700lm	100lm/W	3000K	Φ75x72mm
	12041	12W	1200lm	100lm/W	4000K	Φ75x72mm
	12042	12W	1200lm	100lm/W	3000K	Φ75x72mm
White	12039	7W	700lm	100lm/W	4000K	Φ85x72mm
	12040	7W	700lm	100lm/W	3000K	Φ85x72mm
	12043	12W	1200lm	100lm/W	4000K	Φ85x72mm
	12044	12W	1200lm	100lm/W	3000K	Φ85x72mm



LED CEILING LIGHTS

City Line -Stars Cover

Input Voltage	175-265V 50/60Hz
Beam Angle	120°
CRI	Ra>80
IP Rating	IP20
Dimmable	No

SKU	Watt	Lumen	Lumen/W	Color	Dimension
2849	12W	880lm	73lm/W	6000K	Φ230x65mm
2850	12W	880lm	73lm/W	4500K	Φ230x65mm
2851	12W	880lm	73lm/W	3000K	Φ230x65mm
2852	18W	1550lm	86lm/W	6000K	Φ300x65mm
2853	18W	1550lm	86m/W	4500K	Φ300x65mm
2854	18W	1550lm	86lm/W	3000K	Φ300x65mm
2855	24W	1990lm	83lm/W	6000K	Φ350x65mm
2856	24W	1990lm	83lm/W	4500K	Φ350x65mm
2857	24W	1990lm	83lm/W	3000K	Φ350x65mm

NEW



LED CEILING LIGHT
2xE27 Holder -PIR

Sockets	2xE27	CRI	Ra>80
Input Voltage	AC220-240V 50Hz	IP Rating	IP20
Beam Angle	120°	Dimmable	No

SKU	2819
Color	White

LED SURFACE CEILING
Thermoplastic -PIR



Shape	Round	CRI	Ra>80
Input Voltage	AC220-240V 50Hz	IP Rating	IP20
Beam Angle	120°	Dimmable	No

SKU	Watt	Lumen	Lumen/W	Colour	Dimension
2804	18W	1260lm	70lm/W	6000K	ø295x70mm
2805	18W	1260lm	70lm/W	4500K	ø295x70mm
2806	18W	1260lm	70lm/W	2700K	ø295x70mm

LED SURFACE CEILING
Bulkhead -Thermoplastic



Shape	Bulkhead	CRI	Ra>80
Input Voltage	AC220-240V 50Hz	IP Rating	IP54
Beam Angle	120°	Dimmable	No

SKU	Watt	Lumen	Lumen/W	Colour	Dimension
2801	8W	600lm	75lm/W	6000K	160x90x51mm
2802	8W	600lm	75lm/W	4500K	160x90x51mm
2803	8W	600lm	75lm/W	2700K	160x90x51mm



LED SURFACE CEILING
Bulkhead -Thermoplastic

Input Voltage	220-240V 50/60Hz
Beam Angle	120°
CRI	Ra>80
IP Rating	IP65
Dimmable	No



LED CEILING LIGHT
CCT -Remote Control +Dimming

Input Voltage	185-265V 50/60Hz
Beam Angle	120°
CRI	Ra>80
IP Rating	IP20
Dimmable	Yes

SKU	Watt	Lumen	Lumen/W	Color	Dimension
2807	8W	640lm	80lm/W	4500K	ø270x102mm
2808	8W	640lm	80lm/W	2700K	ø270x102mm
2813	13W	1050lm	81lm/W	4500K	ø320x113mm
2814	13W	1050lm	81lm/W	2700K	ø320x113mm
2809	8W	640lm	80lm/W	4500K	ø270x102mm
2810	8W	640lm	80lm/W	2700K	ø270x102mm
2815	13W	1050lm	81lm/W	4500K	ø320x113mm
2816	13W	1050lm	81lm/W	2700K	ø320x113mm
2811	8W	640lm	80lm/W	4500K	ø270x102mm
2812	8W	640lm	80lm/W	2700K	ø270x102mm
2818	13W	1050lm	81lm/W	2700K	ø320x113mm

SKU	Watt	Lumen	Lumen/W	Color	Dimension
2858	36W	2500lm	70lm/W	CCT	Φ460x70mm
2859	60W	3600lm	60lm/W	CCT	Φ560x70mm

SKU	Watt	Lumen	Lumen/W	Color	Dimension
2860	36W	2700lm	75lm/W	CCT	430x430x70mm
2861	60W	4500lm	75lm/W	CCT	530x530x70mm



LED CEILING LIGHT	
Round -SMD5630	
Input Voltage	175-260V 50/60Hz
Beam Angle	120°
CRI	Ra>80
IP Rating	IP20
Dimmable	No

	SKU	Watt	Lumen	Lumen/W	Color	Dimension
Black	2901	18W	1440lm	80lm/W	4500K	Φ250x80mm
	2902	18W	1440lm	80lm/W	3000K	Φ250x80mm
	2905	30W	2400lm	80lm/W	4500K	Φ400x80mm
	2906	30W	2400lm	80lm/W	3000K	Φ400x80mm
	2909	54W	4050lm	75lm/W	4500K	Φ600x80mm
	2910	54W	4050lm	75lm/W	3000K	Φ600x80mm
White	2903	18W	1440lm	80lm/W	4500K	Φ250x80mm
	2904	18W	1440lm	80lm/W	3000K	Φ250x80mm
	2907	30W	2400lm	80lm/W	4500K	Φ400x80mm
	2908	30W	2400lm	80lm/W	3000K	Φ400x80mm
	2911	54W	4050lm	75lm/W	4500K	Φ600x80mm
	2912	54W	4050lm	75lm/W	3000K	Φ600x80mm



LED CEILING LIGHT	
Round -SMD5630	
Input Voltage	175-260V 50/60Hz
Beam Angle	120°
CRI	Ra>80
IP Rating	IP20
Dimmable	No

	SKU	Watt	Lumen	Lumen/W	Color	Dimension
Black	2913	36W	2700lm	75lm/W	4500K	Φ500x80mm
	2914	36W	2700lm	75lm/W	3000K	Φ500x80mm
	2917	64W	4800lm	75lm/W	4500K	Φ800x80mm
	2918	64W	4800lm	75lm/W	3000K	Φ800x80mm
	White	2915	36W	2700lm	75lm/W	4500K
2916		36W	2700lm	75lm/W	3000K	Φ500x80mm
2919		64W	4800lm	75lm/W	4500K	Φ800x80mm
2920		64W	4800lm	75lm/W	3000K	Φ800x80mm



LED CEILING LIGHT	
Square -SMD5630	
Input Voltage	175-260V 50/60Hz
Beam Angle	120°
CRI	Ra>80
IP Rating	IP20
Dimmable	No

	SKU	Watt	Lumen	Lumen/W	Color	Dimension
Black	2921	30W	2250lm	75lm/W	4500K	380x380x80mm
	2922	30W	2250lm	75lm/W	3000K	380x380x80mm
	2925	64W	4800lm	75lm/W	4500K	600x600x80mm
	2926	64W	4800lm	75lm/W	3000K	600x600x80mm
White	2923	30W	2250lm	75lm/W	4500K	380x380x80mm
	2924	30W	2250lm	75lm/W	3000K	380x380x80mm
	2927	64W	4800lm	75lm/W	4500K	600x600x80mm
	2928	64W	4800lm	75lm/W	3000K	600x600x80mm

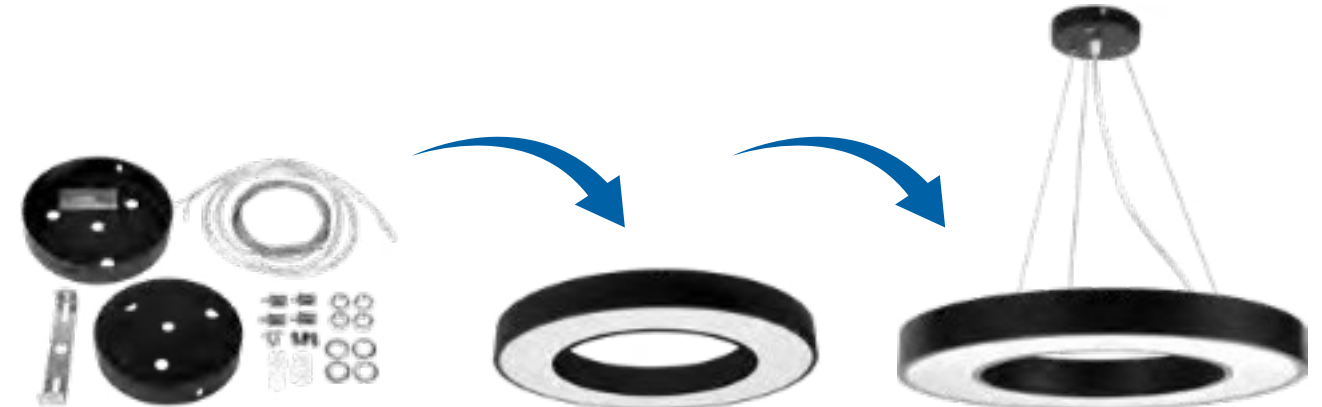

HANGING ACCESSORIES	
FOR SKU:2901-2928	
Material	Metal+plastic-coated
Dimensions	120x25mm

SKU	Color
5180	White
5181	Black





LED DOWNLIGHTSURFACE	
Bridgelux Chip -Aluminium	
Input Voltage	220-240V 50/60Hz
Beam Angle	24°
CRI	Ra>90
IP Rating	IP20
Dimmable	No



	SKU	Watt	Lumen	Lumen/W	Color	Dimension
Black	12001	10W	800lm	80lm/W	4000K	Φ100x65mm
	12002	10W	800lm	80lm/W	3000K	Φ100x65mm
White	12003	10W	800lm	80lm/W	4000K	Φ100x65mm
	12004	10W	800lm	80lm/W	3000K	Φ100x65mm



LED DOWNLIGHTSURFACE	
Adjustable -Aluminium	
Input Voltage	220-240V 50/60Hz
Beam Angle	24°
CRI	Ra>90
IP Rating	IP20
Dimmable	No



	SKU	Watt	Lumen	Lumen/W	Color	Dimension
Black	12005	12W	960lm	80lm/W	4000K	Φ100x100mm
	12006	12W	960lm	80lm/W	3000K	Φ100x100mm
White	12007	12W	960lm	80lm/W	4000K	Φ100x100mm
	12008	12W	960lm	80lm/W	3000K	Φ100x100mm



LED COB DOWNLIGHT	
Adjustable -Aluminium	
Input Voltage	85-265V 50/60Hz
Beam Angle	24°
CRI	Ra>90
IP Rating	IP20
Dimmable	No



	SKU	Watt	Lumen	Lumen/W	Color	Dimension
Black	12021	20W	2000lm	100lm/W	CCT	Φ146x75mm
	12023	30W	3000lm	100lm/W	CCT	Φ176x87mm
White	12022	20W	2000lm	100lm/W	CCT	Φ146x75mm
	12024	30W	3000lm	100lm/W	CCT	Φ176x87mm



LED COB DOWNLIGHT	
Adjustable -Aluminium	

Input Voltage	85-265V 50/60Hz
Beam Angle	24°
CRI	Ra>90
IP Rating	IP20
Dimmable	No

	SKU	Watt	Lumen	Cut Size	Color	Dimension
Black	12025	10W	1000lm	Φ105mm	CCT	Φ120x43mm
	12027	15W	1500lm	Φ150mm	CCT	Φ167x50mm
	12029	30W	3000lm	Φ185mm	CCT	Φ200x550mm
White	12026	10W	1000lm	Φ105mm	CCT	Φ120x43mm
	12028	15W	1500lm	Φ150mm	CCT	Φ167x50mm
	12030	30W	3000lm	Φ185mm	CCT	Φ200x550mm



LED COB DOWNLIGHT	
-Aluminium	

Input Voltage	85-265V 50/60Hz
Beam Angle	24°
CRI	Ra>90
IP Rating	IP20
Dimmable	No

	SKU	Watt	Lumen	Cut Size	Color	Dimension
Black	12031	10W	1000lm	Φ75mm	CCT	Φ86x43mm
	12033	15W	1500lm	Φ95mm	CCT	Φ106x46mm
	12035	20W	2000lm	Φ115mm	CCT	Φ135x51mm
White	12032	10W	1000lm	Φ75mm	CCT	Φ86x43mm
	12034	15W	1500lm	Φ95mm	CCT	Φ106x46mm
	12036	20W	2000lm	Φ115mm	CCT	Φ135x51mm

NEW



LED DOWNLIGHT			
Surface or Build-in-CCT Light			
Power	5W	Beam Angle	55°
Input Voltage	AC220-240V	CRI	Ra>80
Lumens	500lm	IP Rating	IP20
Size	ø92x30 mm	Dimmable	No
SKU	12009		
Color	CCT		



SKU 5045
Chrome bezel



White bezel included

SKU 5046
Brushed bezel



LED SMD DOWNLIGHT			
Fire-Rated -CCT -PF>0.9			
Power	10W	Beam Angle	40°
Input Voltage	AC220-240V	CRI	Ra>80
Lumens	750lm	IP Rating	IP65
Size	ø84x67mm	Dimmable	YES
SKU	5044		
Color	CCT		

NEW



LED DOWNLIGHT			
Power Selectable -CCT Light			
Power	3W-5W-7W	Beam Angle	60°
Input Voltage	AC220-240V	CRI	Ra>80
Lumens	560lmMAX	IP Rating	IP20
Size	ø92x30 mm	Dimmable	No
SKU	13201		
Color	CCT		



Magnetic replaceable covers

LED SMD DOWNLIGHT			
Fire-Rated -PF>0.9			
Power	6W	Beam Angle	40°
Input Voltage	AC220-240V	CRI	Ra>80
Lumens	540lm	IP Rating	IP65
Size	ø84x67mm	Dimmable	YES
SKU	5042	5041	
Color	4500K	3000K	

NEW



LED SPOT/DOWNLIGHT			
3CCT Light -DOB			
Power	5W	Colors	3CCT
Input Voltage	AC220-240V	CRI	Ra>80
Lumens	400lm	IP Rating	IP20
Size	ø50x28mm	Dimmable	No
SKU	1984	1985	
Beam Angle	110°	50°	



Magnetic replaceable covers

LED SMD DOWNLIGHT			
Fire-Rated -CCT -PF>0.9			
Power	8W	Beam Angle	40°
Input Voltage	AC220-240V	CRI	Ra>80
Lumens	630lm	IP Rating	IP65
Size	ø8x80mm	Dimmable	YES
SKU	5043		
Color	CCT		

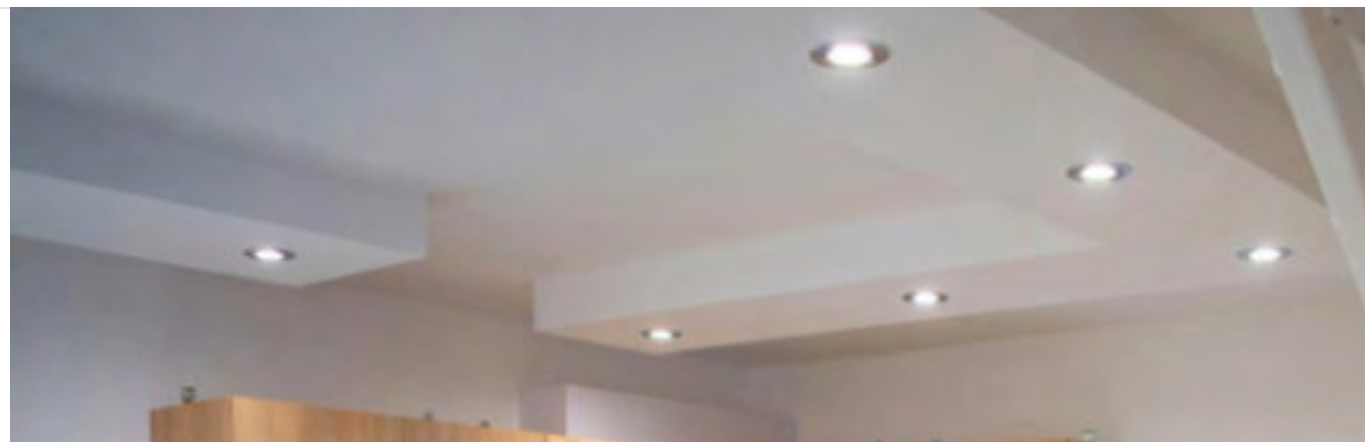

NEW



LED SMD DOWNLIGHT			
Fire-Rated -3CCT -PF>0.9			
Power	10W	Beam Angle	40°
Input Voltage	AC220-240V	CRI	Ra>80
Lumens	900lm	IP Rating	IP20
Size	ø85x69mm	Dimmable	YES
SKU	15002		
Color	CCT		



LED COB DOWNLIGHT

Adjustable -Round

Input Voltage	175-265Vac 50/60Hz
Beam Angle	50°
CRI	Ra>80
IP Rating	IP20
Dimmable	No

SKU	Watt	Lumen	Lumen/W	Color	Dimension
3264	5W	375lm	75lm/W	6000K	Φ90x40mm
3265	5W	375lm	75lm/W	4500K	Φ90x40mm
3266	5W	375lm	75lm/W	2700K	Φ90x40mm
3284	7W	525lm	75lm/W	6000K	Φ90x40mm
3285	7W	525lm	75lm/W	4500K	Φ90x40mm
3286	7W	525lm	75lm/W	2700K	Φ90x40mm
3290	10W	750lm	75lm/W	6000K	Φ115x50mm
3291	10W	750lm	75lm/W	4500K	Φ115x50mm
3292	10W	750lm	75lm/W	2700K	Φ115x50mm



LED COB DOWNLIGHT

Adjustable -Round

Input Voltage	175-265V 50/60Hz
Beam Angle	60°
CRI	Ra>80
IP Rating	IP20
Dimmable	No

SKU	Watt	Lumen	Color	Color	Dimension
3201	8W	560lm	White	6000K	Φ95x55mm
3206	8W	560lm	White	4500K	Φ95x55mm
3202	8W	560lm	White	2700K	Φ95x55mm
3203	8W	560lm	Inox	6000K	Φ95x55mm
3205	8W	560lm	Inox	4500K	Φ95x55mm
3204	8W	560lm	Inox	2700K	Φ95x55mm



LED COB DOWNLIGHT

Adjustable -

Input Voltage	175-265Vac 50/60Hz
Beam Angle	50°
CRI	Ra>80
IP Rating	IP20
Dimmable	No

SKU	Watt	Lumen	Lumen/W	Color	Dimension
3267	5W	375lm	75lm/W	6000K	90x90x40mm
3268	5W	375lm	75lm/W	4500K	90x90x40mm
3269	5W	375lm	75lm/W	2700K	90x90x40mm
3287	7W	525lm	75lm/W	6000K	90x90x40mm
3288	7W	525lm	75lm/W	4500K	90x90x40mm
3289	7W	525lm	75lm/W	2700K	90x90x40mm
3293	10W	750lm	75lm/W	6000K	115x115x50mm
3294	10W	750lm	75lm/W	4500K	115x115x50mm
3295	10W	750lm	75lm/W	2700K	115x115x50mm



LED COB DOWNLIGHT

Adjustable -Square

Input Voltage	175-265V 50/60Hz
Beam Angle	60°
CRI	Ra>80
IP Rating	IP20
Dimmable	No

SKU	Watt	Lumen	Color	Color	Dimension
3207	8W	560lm	White	6000K	100x100x70mm
3222	8W	560lm	White	4500K	100x100x70mm
3212	8W	560lm	White	2700K	100x100x70mm
3223	8W	560lm	Inox	6000K	100x100x70mm
3224	8W	560lm	Inox	4500K	100x100x70mm
3225	8W	560lm	Inox	2700K	100x100x70mm



LED COB DOWNLIGHT

TUV -White

Input Voltage	220-240V 50/60Hz
Beam Angle	145°
CRI	Ra>80
IP Rating	IP20
Dimmable	No

SKU	Watt	Lumen	Lumen/W	Color	Dimension
3270	15W	1200lm	80lm/W	6000K	Φ166x75mm
3271	15W	1200lm	80lm/W	4500K	Φ166x75mm
3272	15W	1200lm	80lm/W	2700K	Φ166x75mm
3273	20W	1600lm	80lm/W	6000K	Φ195x80mm
3274	20W	1600lm	80lm/W	4500K	Φ195x80mm
3275	20W	1600lm	80lm/W	2700K	Φ195x80mm
3276	30W	2500lm	80lm/W	6000K	Φ223x80mm
3277	30W	2500lm	80lm/W	4500K	Φ223x80mm
3278	30W	2500lm	80lm/W	2700K	Φ223x80mm



LED COB DOWNLIGHT

TUV -White

Input Voltage	220-240V 50/60Hz
Beam Angle	145°
CRI	Ra>80
IP Rating	IP20
Dimmable	No

SKU	Watt	Lumen	Lumen/W	Color	Dimension
3260	40W	4000lm	100lm/W	6000K	Φ195x110mm
3261	40W	4000lm	100lm/W	4500K	Φ195x110mm
3262	60W	5600lm	93lm/W	6000K	Φ231x125mm
3263	60W	5600lm	93lm/W	4500K	Φ231x125mm



LED COB DOWNLIGHT

Exchangeable -White

Input Voltage	220-240V 50/60Hz
Beam Angle	60°
CRI	Ra>80
IP Rating	IP20
Dimmable	No



SKU	Watt	Lumen	Lumen/W	Color	Dimension
3241	25W	2200lm	100lm/W	6000K	Φ182x102mm
3242	25W	2200lm	100lm/W	4500K	Φ182x102mm
3243	35W	3000lm	93lm/W	6000K	Φ231x125mm



LED COB DOWNLIGHT

Rotatable -Citizen Chip

Input Voltage	220-240V 50/60Hz
Beam Angle	24°
CRI	Ra>80
IP Rating	IP20
Dimmable	No



SKU	Watt	Lumen	Lumen/W	Color	Dimension
3237	35W	2800lm	80lm/W	6000K	110x150x160mm
3238	35W	2800lm	80lm/W	4500K	110x150x160mm
3239	35W	2800lm	80lm/W	6000K	110x150x160mm



LED DOWNLIGHT

Plastic

Input Voltage	220-240V 50/60Hz
Beam Angle	28°
CRI	Ra>80
IP Rating	IP20
Dimmable	No



	SKU	Watt	Lumen	Shape	Color	Dimension
Black	3296	1W	60lm	Round	3000K	Φ35x29 mm
	3298	1W	60lm	Square	3000K	Φ35x29 mm
White	3297	1W	60lm	Round	3000K	Φ35x29 mm
	3299	1W	60lm	Square	3000K	Φ35x29 mm



LED Strips and Neon Lights

LED strips offer unmatched flexibility in modern lighting design, making them ideal for creative indoor and outdoor projects. Their adaptability allows for unique shapes, hidden accents, or bold highlights, while accessories and controllers add even more possibilities. Whether used as core illumination or atmospheric mood lighting, LED strips are the go-to choice for designers and professionals alike.

Features:

- Up to 80% energy savings compared to traditional lighting
- Highly flexible and durable construction
- Wide range of colours - from single tone to RGB and RGBW
- Multiple IP ratings for indoor or outdoor use
- Dimmable options with smart control compatibility
- Range of accessories for seamless installation and customization

Applications:

- Accent, hidden, or ambient lighting in homes and offices
- Decorative highlights in retail, restaurants, and hotels
- Creative architectural lighting with abstract shapes and forms
- Outdoor projects - facades, gardens, pathways, and signage



LED STRIP 283560 LEDs
4.8W/m -12V

Flux /Meter	300lm/m	Beam Angle	120°
Power / Meter	4.8W/m	CRI	Ra>80
LED Qty	60SMD/m	IP Rating	IP20
Input Voltage	DC: 12V	Width	8mm
Roll Length	5m	Dimmable	Yes

SKU	4702	4700	4703	4704	4706
Color	6000K	4500K	2700K	RED	BLUE



LED STRIP 283560 LEDs
4.8W/m -12V -Waterproof

Flux /Meter	300lm/m	Beam Angle	120°
Power / Meter	4.8W/m	CRI	Ra>80
LED Qty	60SMD/m	IP Rating	IP54
Input Voltage	DC: 12V	Width	8mm
Roll Length	5m	Dimmable	Yes

SKU	4732	4731	4733	4734	4735	4736
Color	6000K	4500K	2700K	RED	GREEN	BLUE



LED STRIP 2835120 LEDs
9.6W/m -12V

Flux /Meter	600lm/m	Beam Angle	120°
Power / Meter	9.6W/m	CRI	Ra>80
LED Qty	120 SMD/m	IP Rating	IP20
Input Voltage	DC: 12V	Width	8mm
Roll Length	5m	Dimmable	Yes

SKU	4710	4740	4711
Color	6000K	4500K	2700K



LED STRIP 2835120 LEDs
9.6W/m -12V -Waterproof

Flux /Meter	600lm/m	Beam Angle	120°
Power / Meter	9.6W/m	CRI	Ra>80
LED Qty	120SMD/m	IP Rating	IP54
Input Voltage	DC: 12V	Width	8mm
Roll Length	5m	Dimmable	Yes

SKU	4720	4721	4722
Color	6000K	4500K	2700K



LED STRIP 2835120 LEDs
Slim -9W/m -12V

Flux /Meter	900lm/m	Beam Angle	120°
Power / Meter	9W/m	CRI	Ra>80
LED Qty	120SMD/m	IP Rating	IP20
Input Voltage	DC: 12V	Width	5mm
Roll Length	5m	Dimmable	Yes

SKU	4907	4908	4909
Color	6000K	4500K	2700K



LED STRIP S-TYPE 283560 LEDs
7.2W/m -12V -Bendable

Flux /Meter	720lm/m	Beam Angle	120°
Power / Meter	7.2W/m	CRI	Ra>80
LED Qty	60SMD/m	IP Rating	IP20
Input Voltage	DC: 12V	Width	6mm
Roll Length	5m	Dimmable	Yes

SKU	4541	4546	4542	4543	4545	4544
Color	7000K	4500K	3000K	RED	GREEN	BLUE



LED STRIP 2835204 LEDs
16.5W/m -12V

Flux /Meter	1700lm/m	Beam Angle	120°
Power / Meter	16.5W/m	CRI	Ra>80
LED Qty	204SMD/m	IP Rating	IP20
Input Voltage	DC: 12V	Width	10mm
Roll Length	5m	Dimmable	Yes

SKU	4761	4762	4763
Color	6000K	4500K	2700K



LED STRIP S-TYPE 283560 LEDs
7.2W/m -12V -Bendable -Waterproof

Flux /Meter	720lm/m	Beam Angle	120°
Power / Meter	7.2W/m	CRI	Ra>80
LED Qty	60SMD/m	IP Rating	IP65
Input Voltage	DC: 12V	Width	6mm
Roll Length	5m	Dimmable	Yes

SKU	4551	4552	4553	4555	4554
Color	7000K	3000K	RED	GREEN	BLUE



LED STRIP 404060 LEDs
10W/m -12V -Waterproof

Flux /Meter	650lm/m	Beam Angle	120°
Power / Meter	10W/m	CRI	Ra>80
LED Qty	60SMD/m	IP Rating	IP44
Input Voltage	DC: 12V	Width	10mm
Roll Length	5m	Dimmable	Yes

SKU	4921	4922	4923
Color	6000K	4500K	2700K



LED STRIP 505030 LEDs
7.2W/m -12V -

Flux /Meter	500lm/m	Beam Angle	120°
Power / Meter	7.2W/m	CRI	Ra>80
LED Qty	30SMD/m	IP Rating	IP20
Input Voltage	DC: 12V	Width	10mm
Roll Length	5m	Dimmable	Yes

SKU	4801	4800	4802	4204
Color	6000K	4500K	2700K	GREEN



LED STRIP 563060 LEDs
8.5W/m -12V

Flux /Meter	1000lm/m	Beam Angle	120°
Power / Meter	12W/m	CRI	Ra>80
LED Qty	120SMD/m	IP Rating	IP20
Input Voltage	DC: 12V	Width	10mm
Roll Length	5m	Dimmable	Yes

SKU	4911	4913	4912
Color	6000K	4500K	2700K



LED STRIP 505060 LEDs
14.4W/m -12V

Flux /Meter	1000lm/m	Beam Angle	120°
Power / Meter	14.4W/m	CRI	Ra>80
LED Qty	60SMD/m	IP Rating	IP20
Input Voltage	DC: 12V	Width	8mm
Roll Length	10m	Dimmable	Yes

SKU	4807	4827	4808	4823	4825
Color	6000K	4500K	2700K	RED	BLUE



LED STRIP 3014120 LEDs
12W/m -12V

Flux /Meter	1000lm/m	Beam Angle	120°
Power / Meter	12W/m	CRI	Ra>80
LED Qty	120SMD/m	IP Rating	IP20
Input Voltage	DC: 12V	Width	8mm
Roll Length	5m	Dimmable	Yes

SKU	4901	4903	4902
Color	6000K	4500K	2700K



LED STRIP 505030 LEDs
7.2W/m -12V -Waterproof

Flux /Meter	500lm/m	Beam Angle	120°
Power / Meter	7.2W/m	CRI	Ra>80
LED Qty	30SMD/m	IP Rating	IP54
Input Voltage	DC: 12V	Width	10mm
Roll Length	5m	Dimmable	Yes

SKU	4809	4811	4810
Color	6000K	4500K	2700K



LED STRIP 4014120 LEDs
12W/m -12V

Flux /Meter	1000lm/m	Beam Angle	120°
Power / Meter	12W/m	CRI	Ra>80
LED Qty	120SMD/m	IP Rating	IP20
Input Voltage	DC: 12V	Width	8mm
Roll Length	5m	Dimmable	Yes

SKU	4904	4905	4906
Color	6000K	4500K	2700K



LED STRIP 505060 LEDs
14.4W/m -12V -Waterproof

Flux /Meter	100lm/m	Beam Angle	120°
Power / Meter	14.4W/m	CRI	Ra>80
LED Qty	60SMD/m	IP Rating	IP54
Input Voltage	DC: 12V	Width	10mm
Roll Length	5m	Dimmable	Yes

SKU	4839	4841	4840	4842	4843
Color	6000K	4500K	2700K	RED	BLUE

NEW



LED STRIP 2835120 LEDs
9W/m -24V

Flux /Meter	1200lm/m	Beam Angle	120°
Power / Meter	9W/m	CRI	Ra>80
LED Qty	120SMD/m	IP Rating	IP20
Input Voltage	DC: 24V	Width	8mm
Roll Length	20m	Dimmable	Yes

SKU	4865	4866	4867
Color	6000K	4500K	3000K

NEW



LED STRIP 2835238 LEDs
18W/m -24V

Flux /Meter	2340lm/m	Beam Angle	120°
Power / Meter	18W/m	CRI	Ra>80
LED Qty	238SMD/m	IP Rating	IP20
Input Voltage	DC: 24V	Width	8mm
Roll Length	5m	Dimmable	Yes

SKU	4877	4878	4879
Color	6000K	4000K	3000K



LED STRIP 2835120 LEDs
9.6W/m -24V

Flux /Meter	1200lm/m	Beam Angle	120°
Power / Meter	9.6W/m	CRI	Ra>80
LED Qty	120SMD/m	IP Rating	IP20
Input Voltage	DC: 24V	Width	8mm
Roll Length	5m	Dimmable	Yes

SKU	4856	4857	4858
Color	6000K	4500K	2700K



LED STRIP 505060 LEDs
14.4W/m -24V

Flux /Meter	600lm/m	Beam Angle	120°
Power / Meter	14.4W/m	CRI	Ra>80
LED Qty	60SMD/m	IP Rating	IP20
Input Voltage	DC: 24V	Width	10mm
Roll Length	5m	Dimmable	Yes

SKU	4851	4850	4852
Color	6000K	4500K	2700K

NEW



LED STRIP 2835126 LEDs
10W/m -24V

Flux /Meter	1300lm/m	Beam Angle	120°
Power / Meter	10W/m	CRI	Ra>80
LED Qty	126SMD/m	IP Rating	IP20
Input Voltage	DC: 24V	Width	8mm
Roll Length	5m	Dimmable	Yes

SKU	4871	4872	4873
Color	6000K	4000K	3000K



LED STRIP 505060 LEDs
14.4W/m -24V -Waterproof

Flux /Meter	600lm/m	Beam Angle	120°
Power / Meter	14.4W/m	CRI	Ra>80
LED Qty	60SMD/m	IP Rating	IP54
Input Voltage	DC: 24V	Width	10mm
Roll Length	5m	Dimmable	Yes

SKU	4853	4854	4855
Color	6000K	4500K	2700K

NEW



LED STRIP 2835182 LEDs
14W/m -24V

Flux /Meter	1820lm/m	Beam Angle	120°
Power / Meter	14W/m	CRI	Ra>80
LED Qty	182SMD/m	IP Rating	IP20
Input Voltage	DC: 24V	Width	8mm
Roll Length	5m	Dimmable	Yes

SKU	4874	4875	4876
Color	6000K	4000K	3000K



LED STRIP COB 640LEDs
12W/m -24V -RGB

Flux /Meter	500lm/m	Beam Angle	120°
Power / Meter	14.4W/m	CRI	Ra>80
LED Qty	640SMD/m	IP Rating	IP20
Input Voltage	DC: 24V	Width	12mm
Roll Length	5m	Dimmable	Yes

SKU	4950
Color	RGB+6000K



LED STRIP COB 320LEDs
10W/m -24V

Flux /Meter	900lm/m	Beam Angle	120°
Power / Meter	10W/m	CRI	Ra>90
LED Qty	320SMD/m	IP Rating	IP20
Input Voltage	DC: 24V	Width	10mm
Roll Length	5m	Dimmable	Yes

SKU	4941	4942	4943
Color	6000K	4000K	3000K



LED STRIP COB 320LEDs
10W/m -24V -D Shape

Flux /Meter	900lm/m	Beam Angle	120°
Power / Meter	10W/m	CRI	Ra>80
LED Qty	320SMD/m	IP Rating	IP65
Input Voltage	DC: 24V	Width	10x4mm
Roll Length	10m	Dimmable	Yes

SKU	4947	4948	4949	6540
Color	6000K	4500K	3000K	FIX CLIP WITH SCREW



LED STRIP COB 512LEDs
12W/m -24V

Flux /Meter	1100lm/m	Beam Angle	120°
Power / Meter	12W/m	CRI	Ra>90
LED Qty	512SMD/m	IP Rating	IP20
Input Voltage	DC: 24V	Width	10mm
Roll Length	5m	Dimmable	Yes

SKU	4944	4945	4946
Color	6000K	4000K	3000K



LED STRIP COB 504LEDs
6W/m -48V -Milky

Flux /Meter	500lm/m	Beam Angle	120°
Power / Meter	6W/m	CRI	Ra>80
LED Qty	504SMD/m	IP Rating	IP67
Input Voltage	DC: 48V	Width	10mm
Roll Length	20m	Dimmable	Yes

SKU	4937	4938	4939	6539
Color	6000K	4500K	3000K	FIX CLIP WITH SCREW



LED STRIP COB 320LEDs
10W/m -24V -Slim

Flux /Meter	1000lm/m	Beam Angle	120°
Power / Meter	10W/m	CRI	Ra>80
LED Qty	320SMD/m	IP Rating	IP20
Input Voltage	DC: 24V	Width	5mm
Roll Length	5m	Dimmable	Yes

SKU	4931	4932	4933
Color	6000K	4000K	3000K



LED STRIP COB 624LEDs
7+7W/m -24V

Flux /Meter	700lm/m	Beam Angle	120°
Power / Meter	7+7W/m	CRI	Ra>80
LED Qty	624SMD/m	IP Rating	IP20
Input Voltage	DC: 24V	Width	10mm
Roll Length	5m	Dimmable	Yes

SKU	4961
Color	CCT



LED STRIP COB 504LEDs
6W/m -48V

Flux /Meter	630lm/m	Beam Angle	120°
Power / Meter	6W/m	CRI	Ra>80
LED Qty	504SMD/m	IP Rating	IP20
Input Voltage	DC: 48V	Width	10mm
Roll Length	25m	Dimmable	Yes

SKU	4934	4935	4936
Color	6000K	4500K	3000K

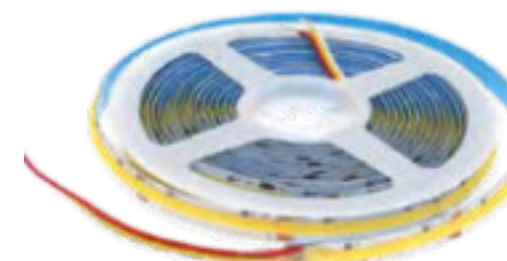

LED STRIP COB 640LEDs
8+8W/m -24V

Flux /Meter	650lm/m	Beam Angle	120°
Power / Meter	8+8W/m	CRI	Ra>80
LED Qty	640SMD/m	IP Rating	IP20
Input Voltage	DC: 24V	Width	10mm
Roll Length	5m	Dimmable	Yes

SKU	4960
Color	CCT

NEW



LEDSTRIP COBSLIM
7W/m -24V

Flux /Meter	560lm/m	Beam Angle	120°
Power / Meter	7W/m	CRI	Ra>80
LED Qty	384SMD/m	IP Rating	IP20
Input Voltage	DC: 24V	Width	3mm
Roll Length	5m	Dimmable	Yes

SKU	4962	4963	4964	6595	6596
Color	6000K	4500K	3000K	CONNECTOR WITH WIRE	2WAY-CONNECTOR WITH WIRE

NEW



LEDSTRIP COBSUPER WIDE
28W/m -24V

Flux /Meter	2800lm/m	Beam Angle	120°
Power / Meter	28W/m	CRI	Ra>80
LED Qty	960SMD/m	IP Rating	IP20
Input Voltage	DC: 24V	Width	20mm
Roll Length	5m	Dimmable	Yes

SKU	4966
Color	3000K

NEW



LED STRIP COB RGB
14W/m -24V

Flux /Meter	1000lm/m	Beam Angle	120°
Power / Meter	14W/m	CRI	Ra>80
LED Qty	576SMD/m	IP Rating	IP20
Input Voltage	DC: 24V	Width	10mm
Roll Length	5m	Dimmable	Yes

SKU	4965
Color	RGB



NEW



LED STRIP COB MAGIC RGB
Digital -16W/m-24V

Flux /Meter	1100lm/m	Beam Angle	120°
Power / Meter	16W/m	CRI	Ra>80
LED Qty	576COB/m	IP Rating	IP20
Input Voltage	DC: 24V	Width	10mm
Roll Length	5m	Dimmable	Yes

SKU	4578
Color	RGB



Accessories
For COB Strips



SKU 6622
MIDDLE CONNECTOR 8mm



SKU 6623
ONE END CONNECTOR WITH WIRE 8mm



SKU 6624
TWO END CONNECTOR WITH WIRE 8mm



SKU 6531
COB FASTEN CONNECTOR 5mm



SKU 6532
COB FASTEN ANGLE CONNECTOR 5mm



SKU 6533
COB FASTEN CONNECTOR WITH WIRE 5mm



SKU 6534
TWO END COB FASTEN CONNECTOR WITH WIRE 5mm



SKU 6535
COB FASTEN CONNECTOR 10mm



SKU 6536
COB FASTEN ANGLE CONNECTOR 10mm



SKU 6537
COB FASTEN CONNECTOR WITH WIRE 10mm



SKU 6538
TWO END COB FASTEN CONNECTOR WITH WIRE 10mm

NEW



SKU 6597
COB RGB FASTEN CONNECTOR 10mm

NEW



SKU 6600
COB RGB FASTEN ANGLE CONNECTOR 10mm

NEW



SKU 6598
COB RGB FASTEN CONNECTOR WITH WIRE 10mm

NEW



SKU 6599
TWO END COB RGB FASTEN CONNECTOR WITH WIRE 10mm

NEW



SKU 6584
COB MAGIC RGB FASTEN CONNECTOR 10mm

NEW



SKU 6587
COB FASTEN ANGLE CONNECTOR 10mm - MAGIC RGB

NEW



SKU 6585
COB FASTEN CONNECTOR WITH WIRE 10mm - MAGIC RGB

NEW



SKU 6586
TWO END COB FASTEN CONNECTOR WITH WIRE 10mm - MAGIC RGB

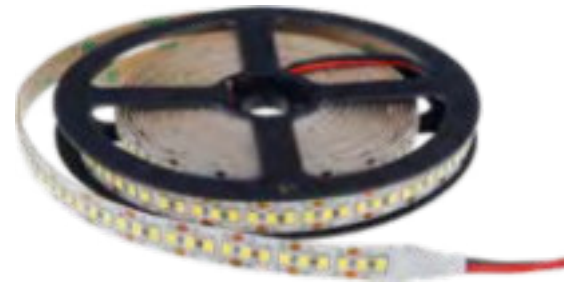

LED STRIP 2835196 LEDs
PREMIUM LINE
20W/m -12V

Flux /Meter	2100lm/m	Beam Angle	120°
Power / Meter	20W/m	CRI	Ra>80
LED Qty	195SMD/m	IP Rating	IP20
Input Voltage	DC:12V	Width	12mm
Roll Length	5m	Dimmable	Yes

SKU	4424	4425	4426
Color	6000K	4200K	2800K



LED STRIP 505460 LEDs
PREMIUM LINE
16W/m -24V

Flux /Meter	1100lm/m	Beam Angle	120°
Power / Meter	16W/m	CRI	Ra>80
LED Qty	60SMD/m	IP Rating	IP20
Input Voltage	DC:24V	Width	12mm
Roll Length	5m	Dimmable	Yes

SKU	4431	4432	4433
Color	6000K	4200K	2800K

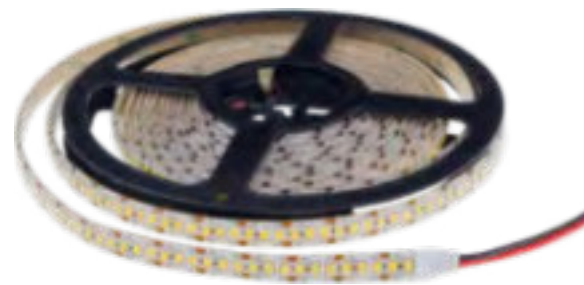

LED STRIP 2835196 LEDs
PREMIUM LINE
20W/m -12V -Waterproof

Flux /Meter	2100lm/m	Beam Angle	120°
Power / Meter	20W/m	CRI	Ra>80
LED Qty	196SMD/m	IP Rating	IP65
Input Voltage	DC:12V	Width	12mm
Roll Length	5m	Dimmable	Yes

SKU	4454	4455	4456
Color	6000K	4200K	2800K



LED STRIP 505460 LEDs
PREMIUM LINE
16W/m -24V -Waterproof

Flux /Meter	1100lm/m	Beam Angle	120°
Power / Meter	16W/m	CRI	Ra>80
LED Qty	60SMD/m	IP Rating	IP65
Input Voltage	DC:24V	Width	12mm
Roll Length	5m	Dimmable	Yes

SKU	4461	4462	4463
Color	6000K	4200K	2800K



LED STRIP 2835196 LEDs
PREMIUM LINE
20W/m -24V

Flux /Meter	2100lm/m	Beam Angle	120°
Power / Meter	20W/m	CRI	Ra>80
LED Qty	196SMD/m	IP Rating	IP20
Input Voltage	DC:24V	Width	12mm
Roll Length	5m	Dimmable	Yes

SKU	4421	4422	4423
Color	6000K	4200K	2800K



LED STRIP 502560 LEDs
PREMIUM LINE
16W/m -24V -CCT

Flux /Meter	800lm/m	Beam Angle	120°
Power / Meter	16W/m	CRI	Ra>80
LED Qty	60SMD/m	IP Rating	IP20 ; 65
Input Voltage	DC:24V	Width	10mm
Roll Length	5m	Dimmable	Yes

SKU	4441	4471
Color	CCT IP20	CCT IP65



LED STRIP 2835196 LEDs
PREMIUM LINE
20W/m - 24V -Waterproof

Flux /Meter	2100lm/m	Beam Angle	120°
Power / Meter	20W/m	CRI	Ra>80
LED Qty	196SMD/m	IP Rating	IP65
Input Voltage	DC:24V	Width	12mm
Roll Length	5m	Dimmable	Yes

SKU	4451	4452	4453
Color	6000K	4200K	2800K



LED STRIP 505060 LEDs
PREMIUM LINE
9.5W/m - 24V -RGB+CCT

Flux /Meter	950lm/m	Beam Angle	120°
Power / Meter	9.5W/m	CRI	Ra>80
LED Qty	60SMD/m	IP Rating	IP20
Input Voltage	DC:24V	Width	10mm
Roll Length	5m	Dimmable	Yes

SKU	4480
Color	RGB+CCT



LED STRIP 505060 LEDs
PREMIUM LINE
16W/m - 12V -RGB

Flux /Meter	1600lm/m	Beam Angle	120°
Power / Meter	16W/m	CRI	Ra>80
LED Qty	60SMD/m	IP Rating	IP20
Input Voltage	DC:12V	Width	12mm
Roll Length	5m	Dimmable	Yes

SKU	4485	4486
Color	RGB+6000K	RGB+3000K



LED STRIP 505030 LEDs
7.2W/m -12V -RGB

Flux /Meter	500lm/m	Beam Angle	120°
Power / Meter	7.2W/m	CRI	Ra>80
LED Qty	30SMD/m	IP Rating	IP20 ;IP54
Input Voltage	DC: 12V	Width	10mm
Roll Length	5m	Dimmable	Yes

SKU	4311	4315
Color	RGB	RGB



LED STRIP 505060 LEDs
PREMIUM LINE
16W/m - 12V -RGB -Waterproof

Flux /Meter	1600lm/m	Beam Angle	120°
Power / Meter	16W/m	CRI	Ra>80
LED Qty	60SMD/m	IP Rating	IP65
Input Voltage	DC:12V	Width	12mm
Roll Length	5m	Dimmable	Yes

SKU	4487	4488
Color	RGB+6000K	RGB+3000K



LED STRIP 505060 LEDs
14.4W/m -12V -RGB

Flux /Meter	1000lm/m	Beam Angle	120°
Power / Meter	14.4W/m	CRI	Ra>80
LED Qty	60SMD/m	IP Rating	IP20 ;IP54
Input Voltage	DC: 12V	Width	10mm
Roll Length	5m	Dimmable	Yes

SKU	4312	4316
Color	RGB	RGB



LED STRIP 505060 LEDs
PREMIUM LINE
16W/m - 24V -RGB

Flux /Meter	1600lm/m	Beam Angle	120°
Power / Meter	16W/m	CRI	Ra>80
LED Qty	60SMD/m	IP Rating	IP20
Input Voltage	DC:24V	Width	10mm
Roll Length	5m	Dimmable	Yes

SKU	4481	4482
Color	RGB+6000K	RGB+3000K



LED STRIP 505060 LEDs
14.4W/m -12V -RGB

Flux /Meter	1000lm/m	Beam Angle	120°
Power / Meter	14.4W/m	CRI	Ra>80
LED Qty	60SMD/m	IP Rating	IP20
Input Voltage	DC: 12V	Width	12mm
Roll Length	5m	Dimmable	Yes

SKU	4313	4314
Color	RGB+6000K	RGB+3000K



LED STRIP 505060 LEDs
PREMIUM LINE
16W/m - 24V -RGB -Waterproof

Flux /Meter	1600lm/m	Beam Angle	120°
Power / Meter	16W/m	CRI	Ra>80
LED Qty	60SMD/m	IP Rating	IP65
Input Voltage	DC:24V	Width	10mm
Roll Length	5m	Dimmable	Yes

SKU	4483	4484
Color	RGB+6000K	RGB+3000K



LED STRIP 505060 LEDs
14.4W/m -24V -RGB

Flux /Meter	1000lm/m	Beam Angle	120°
Power / Meter	14.4W/m	CRI	Ra>80
LED Qty	60SMD/m	IP Rating	IP20 ;IP54
Input Voltage	DC: 24V	Width	10mm
Roll Length	5m	Dimmable	Yes

SKU	4361	4362
Color	RGB	RGB





LED SMD Digital Strip

PREMIUM LINE
Addressable

Beam Angle	120°
CRI	Ra>80
IP Rating	IP20
Dimmable	Yes

SKU	Watt/Meter	Flux/Meter	LED Qty	Color	Pixels	Voltage
4490	7W/m	550lm/m	30SMD/m	RGB	10Pixels	DC:12V
4491	8W/m	600lm/m	30SMD/m	RGB	30Pixels	DC:5V
4492	16W/m	1200lm/m	60SMD/m	RGB	30Pixels	DC:5V
NEW 4493	12W/m	1200lm/m	60SMD/m	WWA	60Pixels	DC:5V



LED SMD STIPS 2216;2110

PREMIUM LINE
High Power -24V

Input Voltage	DC: 24V
Beam Angle	120°
CRI	Ra>90
IP Rating	IP20
Dimmable	Yes

SKU	Watt/Meter	Flux/Meter	LED Qty	Color	Width
4403	22W/m	1900lm/m	240SMD/m	3000K	10mm
4404	24W/m	2200lm/m	300SMD/m	3000K	10mm
4405	32W/m	2500lm/m	560SMD/m	3000K	12mm
4406	38W/m	3400lm/m	700SMD/m	3000K	12mm



LED STRIP COB RUNNING WATER EFFECT

PREMIUM LINE

SET(ADAPTER+CONTROLLER) -24V

Flux /Meter	720lm/m	Beam Angle	120°
Power / Meter	8W/m	CRI	Ra>80
LED Qty	360SMD/m	IP Rating	IP43
Input Voltage	DC: 24V	Width	20mm
Roll Length	5m	Dimmable	Yes

SKU	4415	4416
Color	4000K	3000K



LED STRIP SMD2835 RUNNING WATER EFFECT

PREMIUM LINE

SET(ADAPTER+CONTROLLER) -12V

Flux /Meter	432lm/m	Beam Angle	120°
Power / Meter	4.8W/m	CRI	Ra>80
LED Qty	126SMD/m	IP Rating	IP65
Input Voltage	DC: 12V	Width	8mm
Roll Length	5m	Dimmable	Yes

SKU	4417	4418
Color	4000K	3000K



LED STRIP SMD2835 RUNNING WATER EFFECT

PREMIUM LINE

120LED/m -24V

Flux /Meter	950lm/m	Beam Angle	120°
Power / Meter	10W/m	CRI	Ra>80
LED Qty	120SMD/m	IP Rating	IP65
Input Voltage	DC: 24V	Width	8mm
Roll Length	10m	Dimmable	Yes

SKU	4940
Color	4500K



DIGITALLED STRIP CONTROLLER

DC 5-24V SD-Card

Voltage	5V-24V	Dimension	160x95x30mm
IP Rating	IP20	Supported Pixels	1024/2048



SKU 6331

DIGITALLED STRIP CONTROLLER

DC 5V -14Keys -Remote Control

Voltage	5V	Dimension	80x40x6mm
IP Rating	IP20	Material	Plastic



SKU 6332

DIGITALLED STRIP CONTROLLER

WWA DC5-24V SPI-Signal for SKU:4493

Voltage	5V-24V	Dimension	160x95x30mm
IP Rating	IP20	OutputSignal	SPI



SKU 6333

MAGIC RGB CONTROLLER

2.4GHz Bluetooth Remote Controller -24 Keys

Voltage	5V-24V	Dimension	160x95x30mm
IP Rating	IP20	OutputSignal	SPI



SKU 6582

RF CONTROLLER

DC12-24V

Voltage	12V-24V	Mode	28 kinds
IP Rating	IP20	OutputSignal	1 GroupSPI



SKU 6541

AMPLIFIER

DC5-24V2*4=8GROUP SPI SIGNAL

Voltage	5V-24V	Output	2x4GroupSPI
IP Rating	IP20	OutputSignal	SPI



SKU 6542



LED COB STRIP -MILKY COVER 220V

288 LED/m -50cm Cut

Flux /Meter	700lm/m	Beam Angle	120°
Power / Meter	10W/m	CRI	Ra>80
LED Qty	288COB/m	IP Rating	IP65
Input Voltage	AC:220V	Width	12mm
Roll Length	50m	Dimmable	Yes



SKU	4954	4955	4956
Color	6000K	4500K	3000K



SKU 6546
INPUT CABLE +CONNECTOR



SKU 6457
FLUX CLIPS



SKU 6548
END CAP FOR COB220V



LED COB STRIP - CONNECT-ANYWAY220V

360 LED/m -10cm Cut

Flux /Meter	700lm/m	Beam Angle	120°
Power / Meter	10W/m	CRI	Ra>80
LED Qty	288COB/m	IP Rating	IP65
Input Voltage	AC:220V	Width	12mm
Roll Length	50m	Dimmable	Yes



SKU	4957	4958	4959
Color	6000K	4000K	3000K



SKU 6592
CONNECT 5mm FOR 220V



SKU 6593
END Cap for COB 220V



LED STRIP 220V
2835 120SMD/m

Flux /Meter	900lm/m	Beam Angle	120°
Power / Meter	9W/m	CRI	Ra>80
LED Qty	120SMD/m	IP Rating	IP65
Input Voltage	AC:220V	Width	10mm
Roll Length	50m	Dimmable	Yes



SKU	4951	4952	4953
Color	6000K	4500K	3000K



SKU 6543
INPUT CABLE +CONNECTOR



SKU 6544
FLIX CLIPS



SKU 6545
END CAP FOR 2835



NEW

SUPER SLIM LEDFLEX NEON24V
SIDE BEND 2835 120SMD/m

Flux /Meter	400lm/m	Beam Angle	120°
Power / Meter	8W/m	CRI	Ra>80
LED Qty	120SMD/m	IP Rating	IP65
Input Voltage	DC:24V	Dimension	4x8mm
Roll Length	50m	Dimmable	Yes



SKU	4576	4575	4574	6588	6589
Color	6000K	4500K	3000K	End Cap with hole	End Cap



LED FLEX NEON 24V
2835 140 SMD/m

Flux /Meter	300lm/m	Beam Angle	120°
Power / Meter	10W/m	CRI	Ra>80
LED Qty	140SMD/m	IP Rating	IP65
Input Voltage	DC:24V	Dimension	12x20mm
Roll Length	5m	Dimmable	Yes



SKU	4571	4572	4573	6591
Color	6000K	4400K	3000K	Fix clips



LED STRIP 220V
5730 120 SMD/m

Flux /Meter	500lm/m	Beam Angle	120°
Power / Meter	10W/m	CRI	Ra>80
LED Qty	120SMD/m	IP Rating	IP65
Input Voltage	AC:220V	Width	14mm
Roll Length	50m	Dimmable	Yes



SKU	4611	4613	4612
Color	6000K	4000K	2800K



SKU 6631
INPUT CABLE +CONNECTOR+PLUG



SKU 6632
FLIX CLIPS



SKU 6633
MIDDLE CONNECTOR



SKU 6627
END CAP FOR 5730



LED FLEX NEON -MAGIC RGB
5050 72 SMD/m

Flux /Meter	250lm/m	Beam Angle	120°
Power / Meter	9W/m	CRI	Ra>80
LED Qty	72SMD/m	IP Rating	IP65
Input Voltage	DC:24V	Dimension	6x12mm
Roll Length	5m	Dimmable	Yes



SKU	4579	6581
Color	Magic RGB	Fix clips





LED FLEX NEON 12V
2835 120SMD/m -25m

Roll Length	25m
Beam Angle	120°
CRI	Ra>80
IP Rating	IP65
Dimmable	No

SKU	Watt/m	Lumen/m	Voltage	Color	Dimension
4590	6W/m	300lm/m	DC:12V	6000K	18x8 mm
4591	6W/m	300lm/m	DC:12V	4500K	18x8 mm
4592	6W/m	300lm/m	DC:12V	2800K	18x8 mm
4593	6W/m	300lm/m	DC:12V	Blue	18x8mm
4594	6W/m	300lm/m	DC:12V	Red	18x8mm
4595	6W/m	300lm/m	DC:12V	Green	18x8 mm
4596	6W/m	300lm/m	DC:12V	Ice Blue	18x8mm
4597	6W/m	300lm/m	DC:12V	Lemon	18x8mm
4598	6W/m	300lm/m	DC:12V	Golden	18x8 mm
4599	6W/m	300lm/m	DC:12V	Purple	18x8mm



LED FLEX NEON 220V
2835 120SMD/m -50m

Roll Length	50m
Beam Angle	120°
CRI	Ra>80
IP Rating	IP65
Dimmable	No

SKU	Watt/m	Lumen/m	Voltage	Color	Dimension
4581	8.5W/m	300lm/m	AC:220V	6000K	16x10mm
4580	8.5W/m	300lm/m	AC:220V	4500K	16x10mm
4582	8.5W/m	300lm/m	AC:220V	2800K	16x10mm
4583	8.5W/m	300lm/m	AC:220V	Blue	16x10mm
4584	8.5W/m	300lm/m	AC:220V	Red	16x10mm
4585	8.5W/m	300lm/m	AC:220V	Green	16x10mm
4586	8.5W/m	300lm/m	AC:220V	Amber	16x10mm
4587	8.5W/m	300lm/m	AC:220V	Yellow	16x10mm
4588	8.5W/m	300lm/m	AC:220V	Pink	16x10mm
4589	8.5W/m	300lm/m	AC:220V	RGB	25x13mm



SKU 6602
CONNECTOR WITH ONE SIDE WIRE FOR NEON FLEX



SKU 6603
MOUNTING BRACKET FOR NEON FLEX



SKU 6601
ALUMINIUM CLIPS FOR NEON FLEX



SKU 6605
END CAP FOR NEON FLEX



SKU 6634
MIDDLE CONNECTOR



SKU 6635
INPUT CABLE + CONNECTOR + PLUG



SKU 6636
ALUMINIUM CHANNEL WITH 2 SCREWS, 5CM SINGLE COLOUR



SKU 6637
END CAP FOR SINGLE COLOUR



SKU 6604
MIDDLE CONNECTOR



SKU 6591
FLEX CLIP FOR NEON



SKU 6638
POWER CABLE + RGB CONTROLLER (PIN CONNECTOR + END CAP)



SKU 6639
ALUMINIUM CHANNEL WITH 2 SCREWS, 5CM RGB



SKU 6640
END CAP FOR RGB

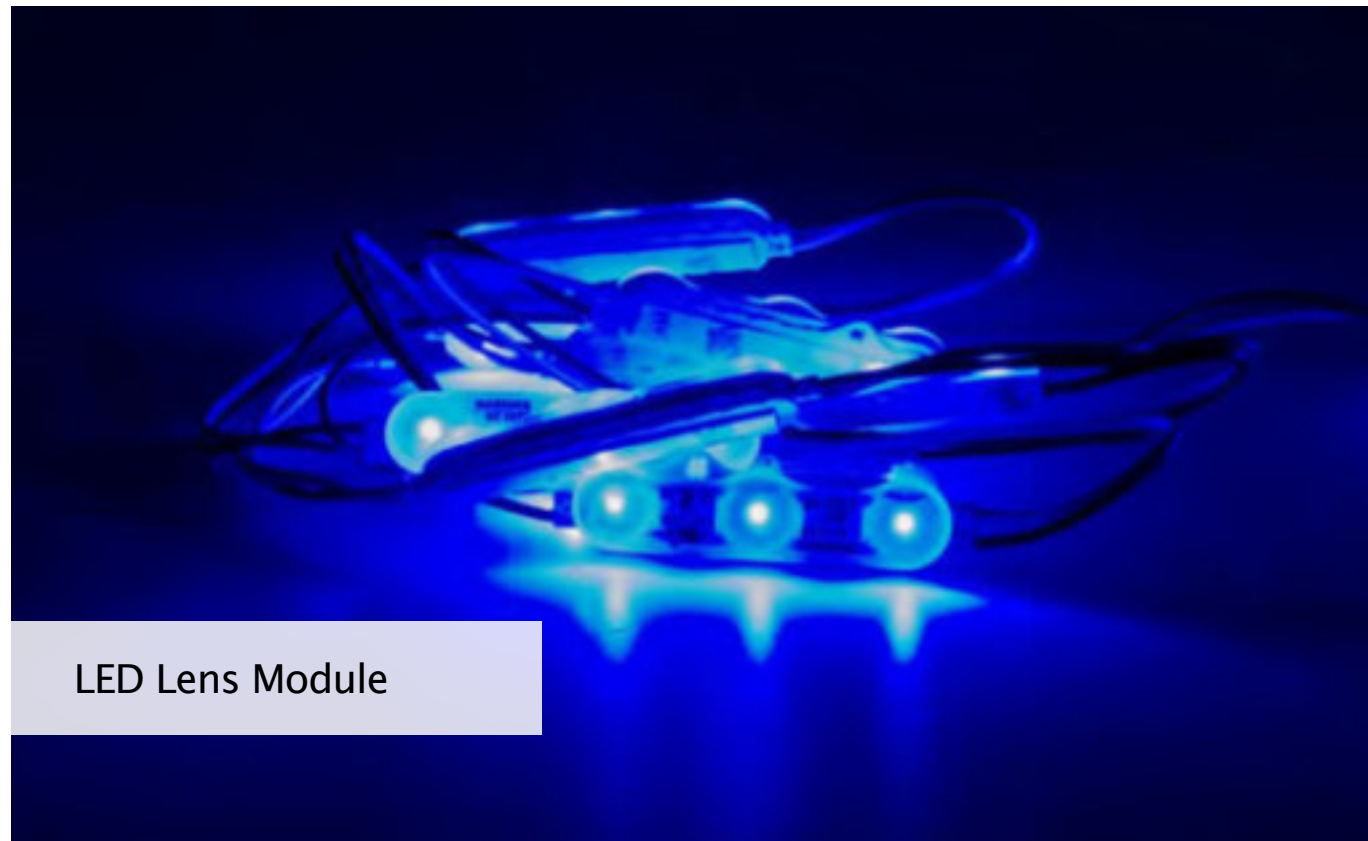

LED Lens Module



LENS LED MODULE 220V
3x3014 SMD –Waterproof

Power/Module	1.6W	Beam Angle	160°
Input Voltage	AC 220–240V	CRI	Ra>80
LED Qty	3 Pcs	IP Rating	67
Flux per Watt	70lm/W	Dimension	88x22x11mm

SKU	4564
Color	6000K



LENS LED MODUL RGB
3x5050 SMD –Waterproof

Power/Module	0.72W	Beam Angle	160°
Input Voltage	DC 12V	CRI	Ra>80
LED Qty	3 Pcs	IP Rating	65
Flux per Watt	118lm/W	Dimension	70x16x8mm

SKU	4563
Color	RGB



LENS LED MODULE
3x2835 SMD –Waterproof

Power/Module	0.72W	Beam Angle	120°
Input Voltage	DC 12V	CRI	Ra>80
LED Qty	3 Pcs	IP Rating	65
Flux per Watt	110lm/W	Dimension	58x12mm

SKU	4512	4511	4513	4514	4516	4515
Color	10000K	7000K	3000K	RED	GREEN	BLUE



LENS LED MODULE
3x3014 SMD –Waterproof

Power/Module	0.36W	Beam Angle	120°
Input Voltage	DC 12V	CRI	Ra>80
LED Qty	3 Pcs	IP Rating	65
Flux per Watt	85lm/W	Dimension	18x8x3mm

SKU	4531	4533	4535	4534
Color	7000K	RED	GREEN	Blue



LENS LED MODULE
3x2835 SMD –Waterproof

Power/Module	1.5W	Beam Angle	160°
Input Voltage	DC 12V	CRI	Ra>80
LED Qty	3 Pcs	IP Rating	65
Flux per Watt	80lm/W	Dimension	75x15mm

SKU	4522	4521	4523	4524	4526	4525
Color	10000K	7000K	3000K	RED	GREEN	BLUE



LENS LED MODULE
4x2835 SMD –Waterproof

Power/Module	2.4W	Beam Angle	160°
Input Voltage	DC 12V	CRI	Ra>80
LED Qty	4 Pcs	IP Rating	65
Flux per Watt	100lm/W	Dimension	43x35x6.5mm

SKU	4561	4562
Color	7000K	3000K



LED STRIP SET 12V 505030 LEDs
Adapter +Controller +Remote

Flux /Meter	240lm/m	Beam Angle	120°
Power / Meter	4W/m	CRI	Ra>80
LED Qty	30SMD/m	IP Rating	IP20
Input Voltage	DC: 12V	Width	10mm
Roll Length	5m	Dimmable	Yes

SKU	4321
Color	RGB



SMART LED STRIP SET 12V 5050+283560LEDs
Adapter +Wifi Controller

Flux /Meter	240lm/m	Beam Angle	120°
Power / Meter	4W/m	CRI	Ra>80
LED Qty	60SMD/m	IP Rating	IP20
Input Voltage	DC: 12V	Width	10mm
Roll Length	2m	Dimmable	Yes

SKU	4324	4325
Color	RGB+W	RGB+WW



LED STRIP SET 12V 505060 LEDs
Adapter +Controller +Remote

Flux /Meter	480lm/m	Beam Angle	120°
Power / Meter	8W/m	CRI	Ra>80
LED Qty	60SMD/m	IP Rating	IP20 ;IP54
Input Voltage	DC: 12V	Width	10mm
Roll Length	5m	Dimmable	Yes

SKU	4322	4323
Color	RGB IP20	RGB IP54



SMART LED STRIP SET 12V 5050+283590LEDs
Adapter +Wifi Controller

Flux /Meter	360lm/m	Beam Angle	120°
Power / Meter	6W/m	CRI	Ra>80
LED Qty	90SMD/m	IP Rating	IP20
Input Voltage	DC: 12V	Width	10mm
Roll Length	3m	Dimmable	Yes

SKU	4326
Color	RGB+CCT



LED STRIP SET 12V 505030 LEDs
Adapter +Bluetooth +Remote

Flux /Meter	240lm/m	Beam Angle	120°
Power / Meter	4W/m	CRI	Ra>80
LED Qty	30SMD/m	IP Rating	IP20
Input Voltage	DC: 12V	Width	10mm
Roll Length	5m	Dimmable	Yes

SKU	4328
Color	RGB



TV LED Strip 5V 5050+283560LEDs -SET
Wifi Controller +Remote

Flux /Meter	240lm/m	Beam Angle	120°
Power / Meter	4W/m	CRI	Ra>80
LED Qty	60SMD/m	IP Rating	IP20
Input Voltage	DC: 5V	Width	10mm
Roll Length	2m	Dimmable	Yes

SKU	4327
Color	RGB+WW



LED STRIP SET 12V 505060 LEDs
Adapter +Bluetooth +Remote

Flux /Meter	480lm/m	Beam Angle	120°
Power / Meter	8W/m	CRI	Ra>80
LED Qty	60SMD/m	IP Rating	IP20 ;IP54
Input Voltage	DC: 12V	Width	10mm
Roll Length	5m	Dimmable	Yes

SKU	4329	4330
Color	RGB IP20	RGB IP54

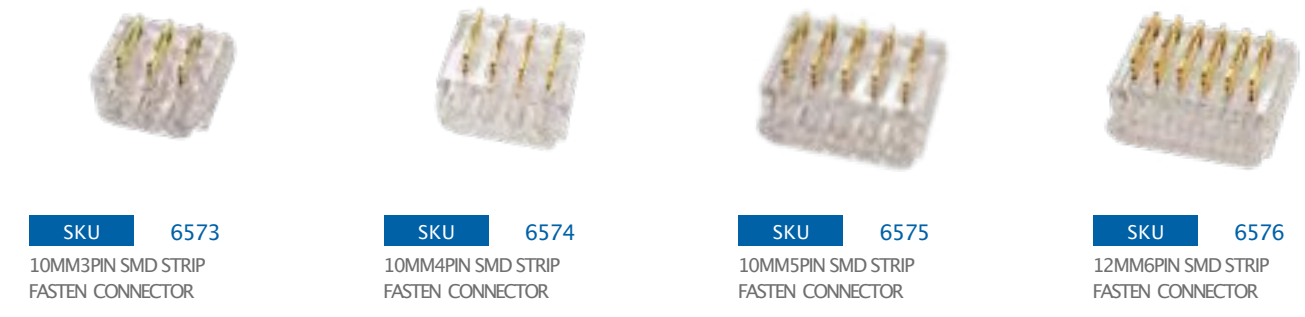

SKU 6573
10MM3PIN SMD STRIP FASTEN CONNECTOR

SKU 6574
10MM4PIN SMD STRIP FASTEN CONNECTOR

SKU 6575
10MM5PIN SMD STRIP FASTEN CONNECTOR

SKU 6576
12MM6PIN SMD STRIP FASTEN CONNECTOR



SKU 6549
2PIN FASTEN CONNECTORSTRIP TO STRIP FOR 8MMCOB



SKU 6550
2PIN FASTEN CONNECTORSTRIP TO WIRE FOR 8MMSMD



SKU 6551
2PIN FASTEN CONNECTORSTRIP TO WIRE FOR 8MM COB



SKU 6552
2PIN FASTEN CONNECTORSTRIP TO WIRE FOR 8MMSMD



SKU 5151
CONNECTORFOR LED STRIP 3528



SKU 5152
CONNECTORFOR LED STRIP 5050



SKU 6606
CONNECTORFORLED STRIP RGBW



SKU 6607
CONNECTORFORLED STRIP RGBW-ANGLE



SKU 6553
2PIN FASTEN DUAL CONNECTORFOR 8MM COB



SKU 6554
2PIN FASTEN DUAL CONNECTORFOR 8MM SMD



SKU 6555
3PIN FASTEN CONNECTORSTRIP TO STRIP FOR10MM3PIN



SKU 6556
3PIN FASTEN CONNECTORWITH WIRE FOR 10MM3PIN



SKU 6608
CONNECTORFORLED STRIP RGB



SKU 6619
ANGLE CONNECTORFOR LED STRIP 3528 8mm



SKU 6620
ANGLE CONNECTORFOR LED STRIP 5050 10mm



SKU 6621
ANGLE CONNECTORFOR LED STRIP RGB 10mm



SKU 6557
ASTEN CONNECTORSTRIP TOSTRIP FOR 10MM5PIN SMDSTRIP RGBW



SKU 6558
FASTEN DUAL CONNECTORFOR 10MM 5PIN SMDSTRIP RGBW



SKU 6559
CLAMP PRESS CONNECTORSTRIP TO STRIP FOR12MM6PIN SMDSTRIP



SKU 6560
CLAMP PRESS DUALCONNECTORFOR 12MM6PIN SMD STRIP



SKU 6610
CONNECTORFOR LED STRIP DCMALE



SKU 6611
CONNECTORFOR LED STRIP DCFEMALE



SKU 6612
FLEXIBLE CONNECTORFORLED STRIP 3528 DCMALE



SKU 6613
FLEXIBLE CONNECTORFORLED STRIP 5050 DCMALE



SKU 6561
WATERPROOF CONNECTORWITH 15CM 2WIRE SMD10MM PCB 2PIN



SKU 6562
DOUBLE WATERPROOF CONNECTOR 15CM2WIRE SMD 10MMPCB 2PIN



SKU 6563
WATERPROOF CONNECTORSMD 10MM PCB 3PIN (CCT,MAGICRGB)



SKU 6564
WATERPROOF CONNECTORWITH 15CM 3WIRE SMD10MM PCB 3PIN (CCT,MAGIC RGB)



SKU 6614
FLEXIBLE CONNECTORFORLED STRIP RGB



SKU 6615
FLEXIBLE CONNECTORFORLED STRIP 3528



SKU 6616
FLEXIBLE CONNECTORFORLED STRIP 5050



SKU 6618
FLEXIBLE CONNECTORFORLED STRIP RGB+WH



SKU 6565
WATERPROOF CONNECTORWITH 15CM 4WIRE SMD10MM PCB 4PIN(RGB)



SKU 6566
WATERPROOF CONNECTORWITH 15CM 5WIRE SMD10MM PCB 5PIN(RGBW)



SKU 6617
FLEXIBLE CONNECTORFORRGB LED STRIP



SKU 6517
4PINS MALE INWHITE FORRGB LED STRIP



SKU 6570
5MM PCB FOR COB/SMD,FASTEN CONNECTOR



SKU 6571
8MM PCB FOR COB/SMD,FASTEN CONNECTOR



SKU 6572
10MMPCB FOR COB/SMD,FASTEN CONNECTOR

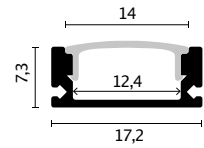

SKU 5190
Silver Body-White Cover (L=1m)

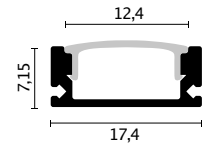

SKU 5191
Silver Body-White Cover (L=2m)

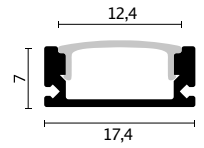

SKU 5184
White Body-White Cover (L=2m)

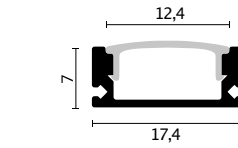

SKU 5185
Black Body-White Cover (L=2m)

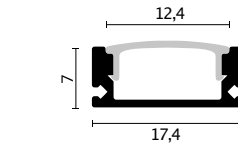

SKU 5107
Black Body-Black Cover (L=2m)

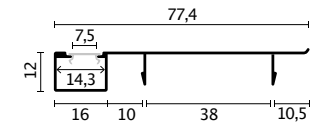

NEW
SKU 15120
Black Body-White Cover (L=2m)

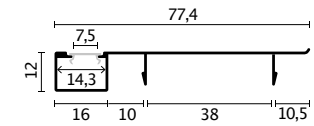

NEW
SKU 15121
White Body-White Cover (L=2m)

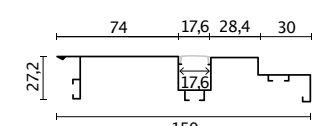

NEW
SKU 15113
White Body-White Cover (L=2m)

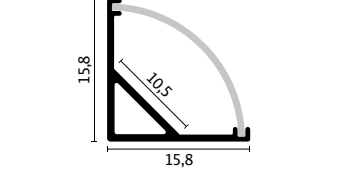

NEW
SKU 5150
Silver Body-White Cover (L=2m)



Flexible/Bendable

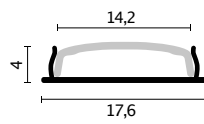

SKU 5002
Silver Body-White Cover (L=1m)

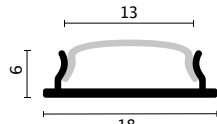

SKU 5001
Silver Body-White Cover (L=2m)

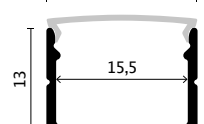

SKU 5132
Silver Body-White Cover (L=2m)

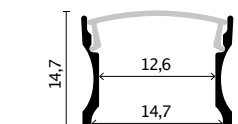

SKU 5133
Silver Body-White Cover (L=2m)

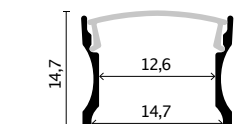

SKU 5175
Silver Body-White Cover (L=2m)

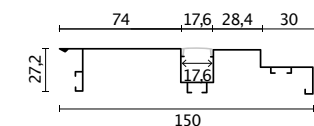

NEW
SKU 15114
White Body-Black Cover (L=2m)

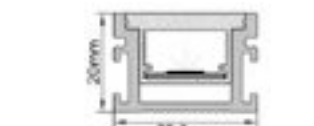

NEW
SKU 15133
Black Body-White Cover (L=2m)



NEW
SKU 15134
Black Body-White Cover (L=2m)



NEW
SKU 15135
Silver Body-White Cover (L=2m)

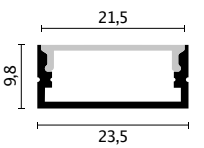

SKU 5183
Black Body-Black Cover (L=2m)

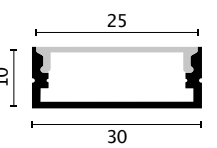

SKU 5115
Silver Body-White Cover (L=2m)

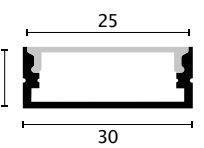

SKU 5116
Black Body-White Cover (L=2m)

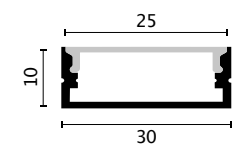

SKU 5114
Black Body-Black Cover (L=2m)

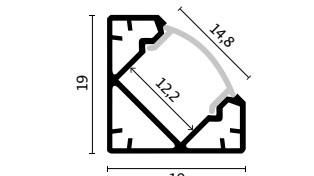

SKU 5194
Silver Body-White Cover (L=1m)

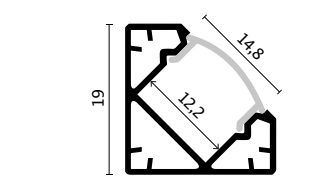

SKU 5103
Silver Body-White Cover (L=2m)

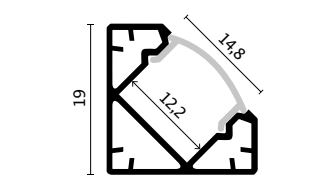

SKU 5102
White Body-White Cover (L=2m)

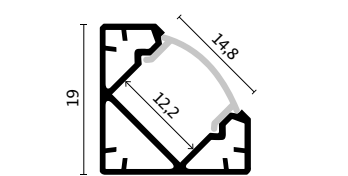

SKU 5100
Black Body-White Cover (L=2m)

SKU 5101
Black Body-Black Cover (L=2m)

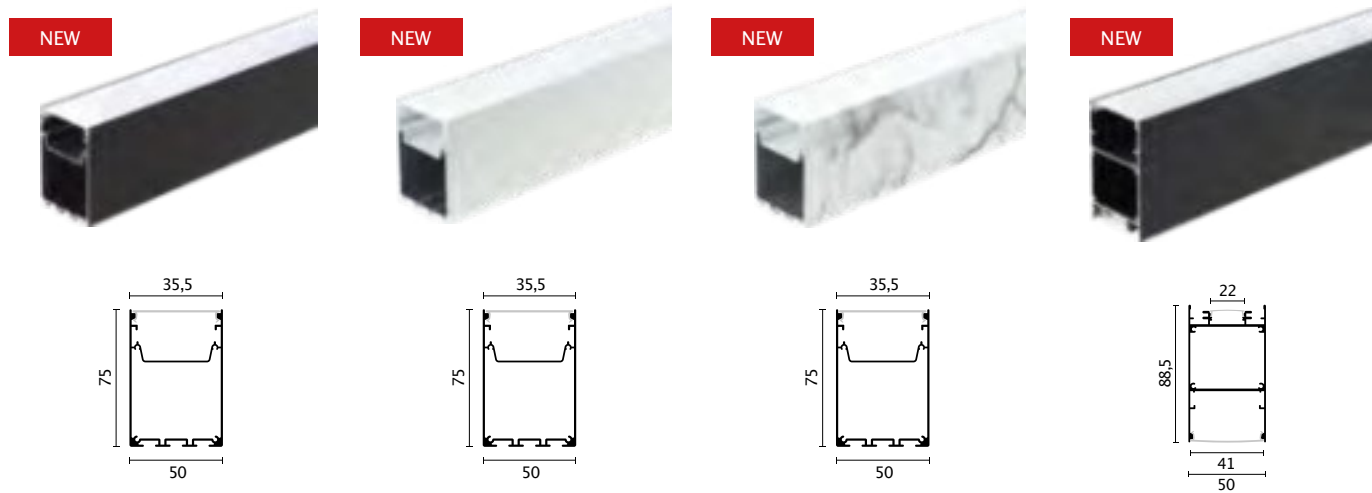

SKU 15124 Body Body-White Cover (L=2m)
 SKU 15125 White Body-White Cover (L=2m)
 SKU 15126 Marble Body-White Cover (L=2m)
 SKU 15127 Black Body-White Cover (L=2m)

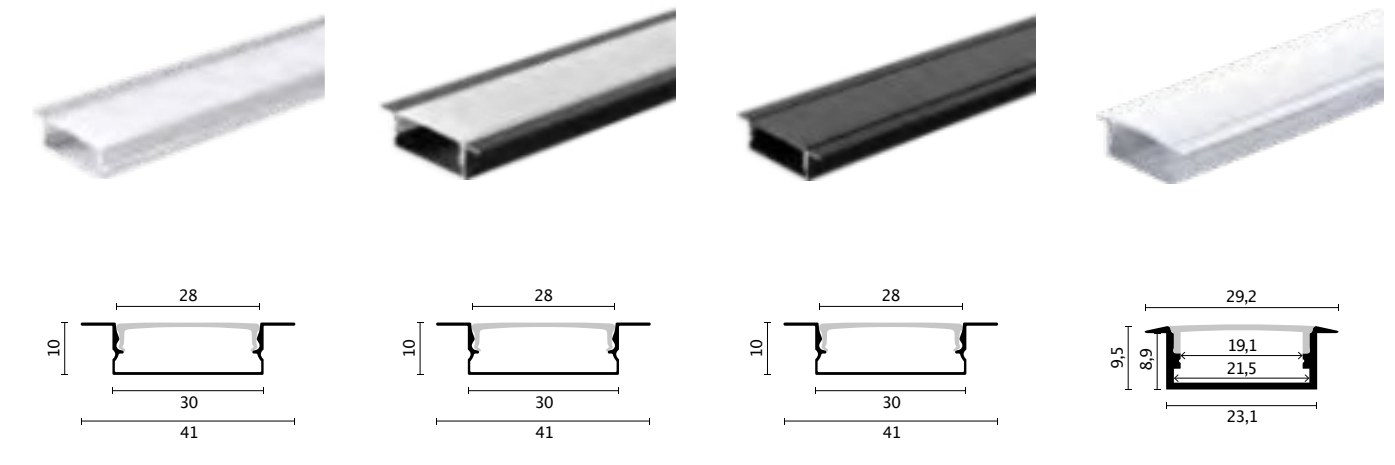

SKU 5118 Silver Body-White Cover (L=2m)
 SKU 5119 Black Body-White Cover (L=2m)
 SKU 5117 Black Body-Black Cover (L=2m)
 SKU 5109 Black Body-White Cover (L=2m)

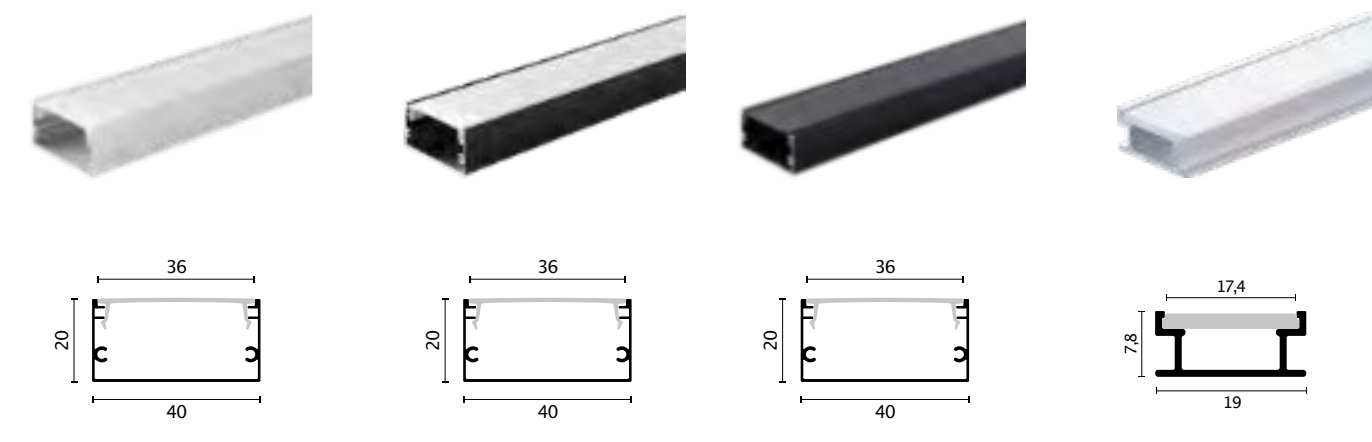

SKU 5121 Silver Body-White Cover (L=2m)
 SKU 5122 Black Body-White Cover (L=2m)
 SKU 5120 Black Body-Black Cover (L=2m)
 SKU 5113 Black Body-Black Cover (L=2m)

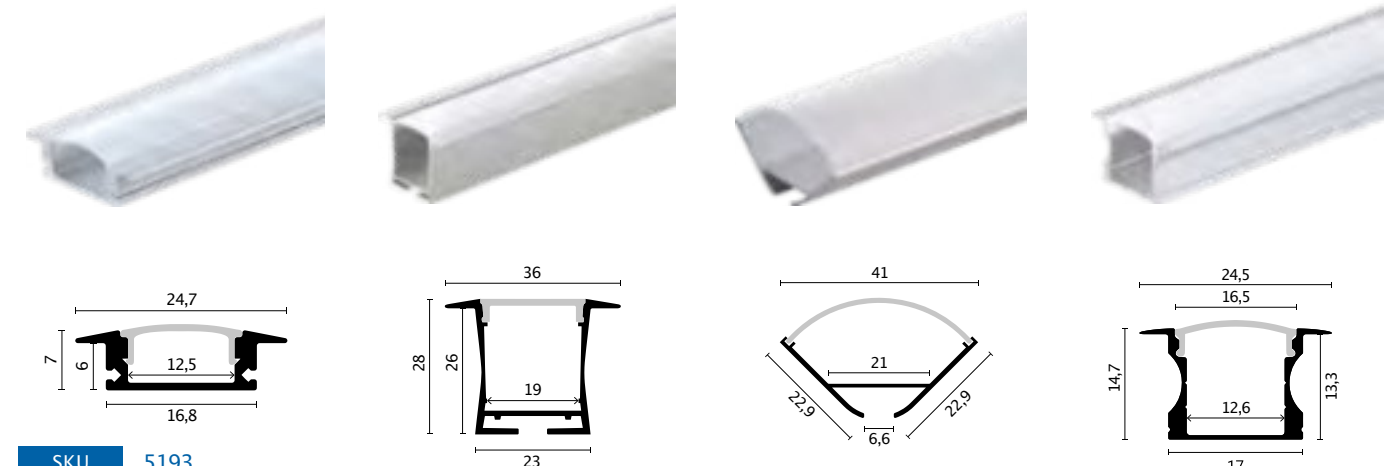

SKU 5193 Silver Body-White Cover (L=1m)
 SKU 5192 Silver Body-White Cover (L=2m)
 SKU 5130 Silver Body-White Cover (L=2m)
 SKU 5110 Silver Body-White Cover (L=2m)
 SKU 5108 Silver Body-White Cover (L=2m)

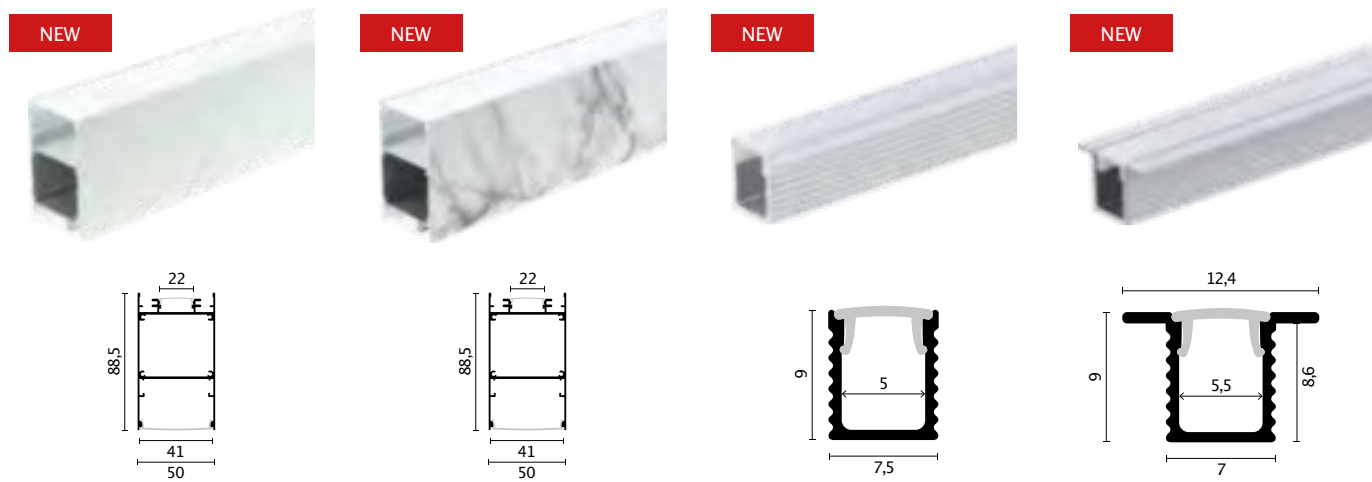

SKU 15128 White Body-White Cover (L=2m)
 SKU 15129 Marble Body-White Cover (L=2m)
 SKU 5142 Silver Body-White Cover (L=2m)
 SKU 5141 Silver Body-White Cover (L=2m)

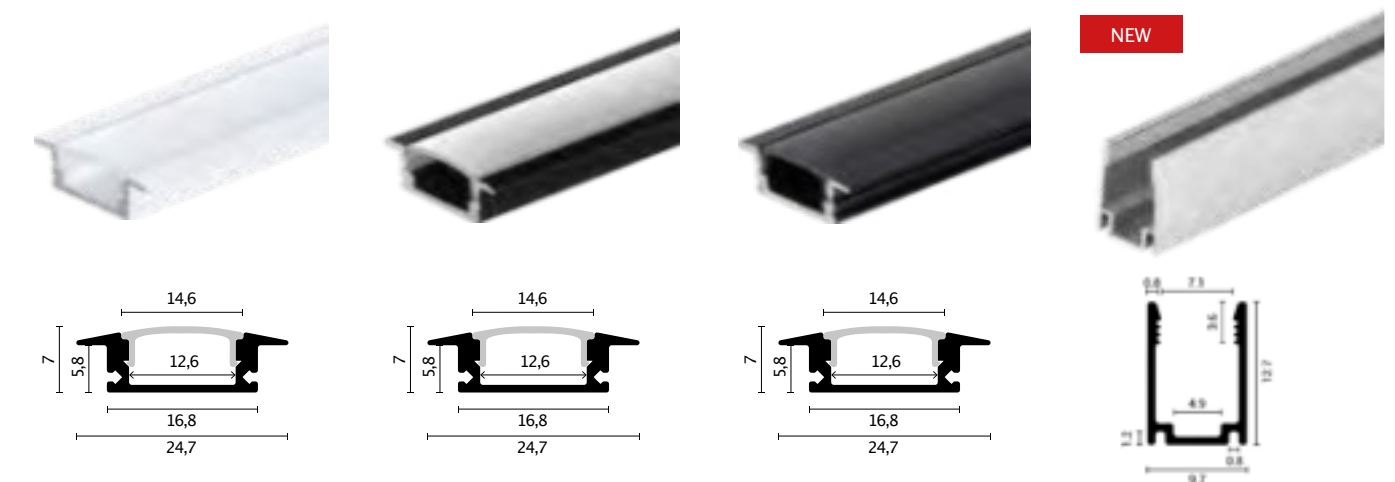

SKU 5106 White Body-White Cover (L=2m)
 SKU 5104 Black Body-White Cover (L=2m)
 SKU 5105 Black Body-Black Cover (L=2m)
 SKU 15136 Silver Body-White Cover (L=2m)

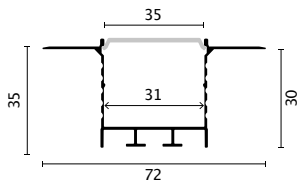

SKU 5123
Silver Body -White Cover (L=2m)

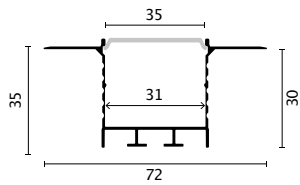

SKU 5125
Black Body -White Cover (L=2m)

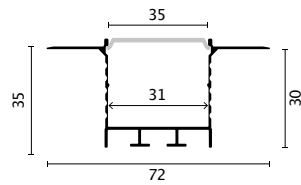

SKU 5124
Black Body -Black Cover (L=2m)

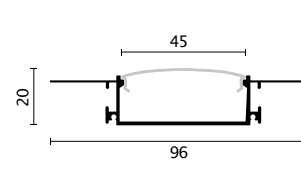

SKU 5134
Silver Body -White Cover (L=2m)

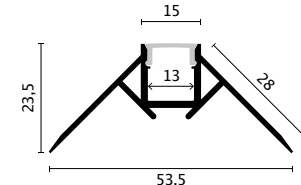

SKU 5165
Silver Body -White Cover (L=2m)

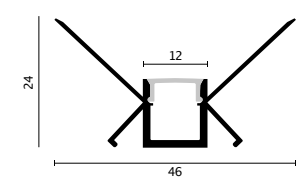

SKU 5166
Black Body -White Cover (L=2m)

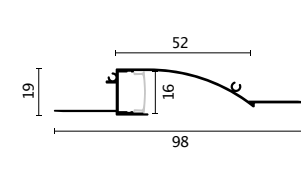

SKU 5128
Silver Body -White Cover (L=2m)

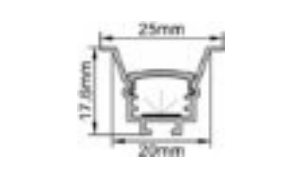

NEW
SKU 15132
Silver Body -White Cover (L=2m)

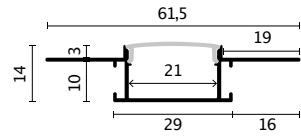

NEW
SKU 5145
Silver Body -White Cover (L=2m)

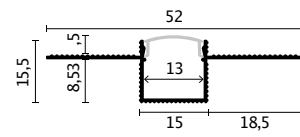

NEW
SKU 15111
Silver Body -White Cover (L=2m)

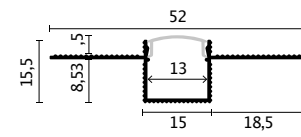

NEW
SKU 15112
Silver Body -Black Cover (L=2m)

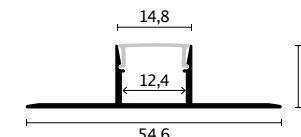

NEW
SKU 5143
Silver Body -White Cover (L=2m)

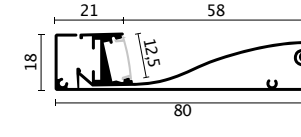

NEW
SKU 15115
Silver Body -White Cover (L=2m)

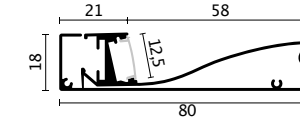

NEW
SKU 15116
Black Body -White Cover (L=2m)

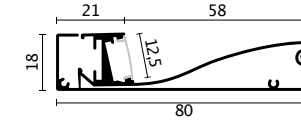

NEW
SKU 15117
Iron Oxide Body -White Cover (L=2m)

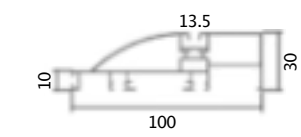

NEW
SKU 15123
White Body -White Cover (L=2m)

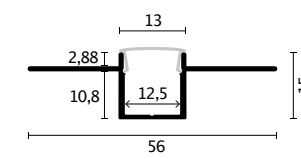

SKU 5162
Silver Body -White Cover (L=2m)

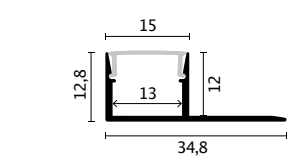

NEW
SKU 5144
Silver Body -White Cover (L=2m)

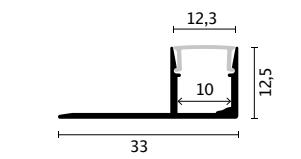

SKU 5111
Silver Body -White Cover (L=2m)

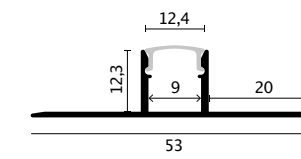

SKU 5112
Silver Body -White Cover (L=2m)

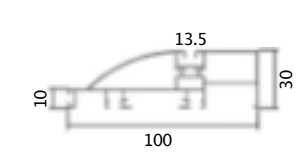

NEW
SKU 15122
Black Body -White Cover (L=2m)

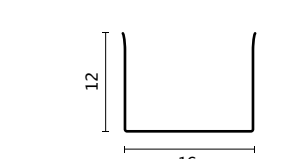

NEW
SKU 15130
Keel Mesh for Neon
Silver Body (L=2m)

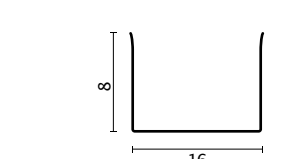

NEW
SKU 15131
Keel Mesh for Neon
Silver Body (L=2m)

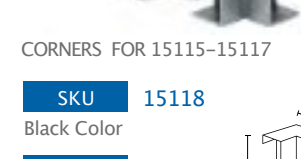

NEW
CORNERS FOR 15115-15117
SKU 15118 Black Color
SKU 15118S Silver Color
SKU 15119 Gray Color



LED Power Supplies and Controllers

Our power supply portfolio covers all major global standards, delivering reliable performance across a wider range of LED applications. Designed with efficiency and durability in mind, they reduce both energy consumption and maintenance costs. Compact narrow-body models ensure easy installation even in confined spaces, making them the perfect choice for professional lighting projects.

Features:

- Available in 5V, 12V, and 24V versions with multiple sizes and shapes
- Specialized dimmable options for LED panels and downlights
- Waterproof models with various IP protection ratings
- Forced heat dissipation for extended lifespan and reliability
- High efficiency for cost-effective operation

Applications:

- Ideal for powering LED strips, panels, and downlights
- Suitable for residential, commercial, and industrial lighting projects
- A core component for every LED installation

NEW



DINRAIL POWER SUPPLY

12V or 24V Output –Metal

Input Voltage	100–240V 50/60Hz
Material	Metal
IP Rating	IP20
Dimmable	No

SKU	Watt	OutputVoltage	Current	Dimension
6275	75W	DC: 12V	6.25A	32x125.2x102mm
6277	120W	DC: 12V	10A	40x125.2x113.5mm
6279	240W	DC: 12V	20A	63x125.2x113.5mm
6276	75W	DC: 24V	3.125A	32x125.2x102mm
6278	120W	DC: 24V	5A	40x125.2x113.5mm
6280	240W	DC: 24V	10A	63x125.2x113.5mm

NEW



LEDPOWER SUPPLIES

Super Slim –Plastic 12V

Input Voltage	175–265V 50/60Hz
Material	Plastic
IP Rating	IP20
Dimmable	No

SKU	Watt	OutputV	Current	Dimension
6291	24W	DC: 12V	2A	117x55x18.5mm
6292	36W	DC: 12V	3A	137x55x18.5mm
6293	60W	DC:12V	5A	169x59x20mm
6294	100W	DC: 12V	8.3A	198x59x20mm
6299	Connector Cable			

NEW



DINRAIL POWER SUPPLY

12V/24V Output –Plastic –Slim

Input Voltage	85–264V 50/60Hz
Material	Plastic
IP Rating	IP20
Dimmable	No

SKU	Watt	OutputV	Current	Dimension
6265	60W	DC: 12V	5A	52.5x90x54.5mm
6267	100W	DC: 12V	8.33A	70x90x54.5mm
6266	60W	DC: 24V	2.5A	52.5x90x54.5mm
6268	100W	DC: 24V	4.16A	70x90x54.5mm

NEW



LEDPOWER SUPPLIES

Slim –12V or 24V with quick connection

Input Voltage	198–242V 50/60Hz
Material	Metal
IP Rating	IP20
Dimmable	No

SKU	Watt	OutputVoltage	Current	Dimension
6235	60W	DC: 12V	5A	131x52x27.3mm
6236	100W	DC: 12V	8.3A	154x52x27.3mm
6237	150W	DC: 12V	12.5A	211x52x27.3mm
6238	200W	DC: 12V	16.5A	211x52x27.3mm
6239	300W	DC: 12V	25A	211x62x28.7mm
6240	400W	DC: 12V	33.3A	240x63x29mm
6245	60W	DC: 24V	2.5A	131x52x27.3mm
6246	100W	DC: 24V	4.1A	154x52x27.3mm
6247	150W	DC: 24V	6.25A	211x52x27.3mm
6248	200W	DC: 24V	8.3A	211x52x27.3mm
6249	300W	DC: 24V	12.5A	211x62x28.7mm
6250	400W	DC: 24V	16.6A	240x63x29mm



TRIAC POWER SUPPLY	
Dimmable 12V or 24V	
Input Voltage	220-240V 50/60Hz
Material	Metal
IP Rating	IP20
Dimmable	YES

SKU	Watt	OutputVoltage	Current	Dimension
6271	75W	DC: 12V	6.25A	190x50x31mm
6272	100W	DC: 12V	8.33A	206x67x37mm
6273	150W	DC: 12V	12.5A	206x67x37mm
6281	75W	DC: 24V	3.1A	119x52x32mm
6282	100W	DC: 24V	4.17A	206x67x37mm
6283	150W	DC: 24V	6.25A	206x67x37mm



LEDPOWER SUPPLIES	
Plastic 12V or24V	
Input Voltage	100-240V 50/60Hz
Material	Plastic
IP Rating	IP20
Dimmable	No

SKU	Watt	OutputVoltage	Current	Dimension
6201	36W	DC: 12V	3A	119x52x32mm
6202	60W	DC: 12V	5A	119x52x32mm
6203	72W	DC: 12V	6A	119x52x32mm
6206	36W	DC: 24V	1.5A	119x52x32mm
6207	60W	DC: 24V	2.5A	119x52x32mm
6208	72W	DC: 24V	3A	119x52x32mm



LEDPOWER SUPPLIES	
Slim -Metal -12V or 24V	
Input Voltage	176-265V 50/60Hz
Material	Metal
IP Rating	IP20
Dimmable	No

SKU	Watt	OutputVoltage	Current	Dimension
6211	60W	DC: 12V	5A	130x50x31mm
6212	100W	DC: 12V	8.4A	190x50x31mm
6213	150W	DC: 12V	12.5A	200x62x31mm
6214	200W	DC: 12V	16.7A	208x82x32mm
6221	60W	DC: 24V	2.5A	130x50x31mm
6222	100W	DC: 24V	4.2A	190x50x31mm
6223	150W	DC: 24V	6.25A	200x60x31mm
6224	200W	DC: 24V	8.35A	208x82x32mm



LEDPOWER SUPPLIES	
Plastic Case 12V or 24V	
Input Voltage	100-240V 50/60Hz
Material	Plastic
IP Rating	IP20
Dimmable	No

SKU	Watt	OutputVoltage	Current	Dimension
6231	24W	DC: 12V	2A	120x42x28mm
6232	36W	DC: 12V	3A	140x48x30mm
6233	60W	DC: 12V	5A	155x53x30mm
6241	24W	DC: 24V	1A	120x42x28mm
6242	36W	DC: 24V	1.5A	140x48x30mm
6243	60W	DC: 24V	2.5A	155x53x30mm



LEDPOWER SUPPLIES

Waterproof –Metal –12V or 24V

Input Voltage	100–240V 50/60Hz
Material	Metal
IP Rating	IP67
Dimmable	No

SKU	Watt	OutputVoltage	Current	Dimension
6251	60W	DC: 12V	5A	158x52x32mm
6252	100W	DC: 12V	8.4A	220x52x32mm
6253	150W	DC: 12V	12.5A	230x65x32mm
6254	200W	DC: 12V	16.7A	244x80x32mm
6261	60W	DC: 24V	2.5A	158x52x32mm
6262	100W	DC: 24V	4.2A	220x52x32mm
6263	150W	DC: 24V	6.25A	230x65x32mm
6264	200W	DC: 24V	8.35A	244x80x32mm



LEDPOWER SUPPLIES

Metal –12V

Input Voltage	110V/220V 50/60Hz
Material	Metal
IP Rating	IP20
Dimmable	No

SKU	Watt	OutputVoltage	Current	Dimension
6104	24W	DC: 12V	2A	85x57x34mm
6121	36W	DC: 12V	3A	85x57x34mm
6105	60W	DC: 12V	5A	110x78x38mm
6109	100W	DC: 12V	8.3A	160x98x42mm
6106	120W	DC: 12V	10A	160x98x42mm
6114	150W	DC: 12V	12.5A	205x100x50mm
6117	250W	DC: 12V	20A	205x115x55mm
6108	360W	DC: 12V	30A	220x115x55mm
6124	500W	DC: 12V	41.5A	220x115x55mm



LEDPOWER SUPPLIES

Waterproof –Metal –12V

Input Voltage	220–240V 50/60Hz
Material	Metal
IP Rating	IP67
Dimmable	No

SKU	Watt	OutputVoltage	Current	Dimension
6110	30W	DC: 12V	2.5A	158x52x32mm
6111	60W	DC: 12V	5A	220x52x32mm
6113	100W	DC: 12V	8.3A	230x65x32mm
6112	150W	DC: 12V	12.5A	244x80x32mm



LEDPOWER SUPPLIES

Metal –24V

Input Voltage	110V/220V 50/60Hz
Material	Metal
IP Rating	IP20
Dimmable	No

SKU	Watt	OutputVoltage	Current	Dimension
6154	60W	DC: 24V	2.5A	116x95x40mm
6151	100W	DC: 24V	4.2A	199x98x42mm
6155	150W	DC: 24V	6.25A	199x98x42mm
6152	250W	DC: 24V	10.5A	200x110x50mm
6153	360W	DC: 24V	15A	220x120x50mm





LEDPOWER SUPPLIES	
Slim Line –Metal –12V /24V	
Input Voltage	220V 50/60Hz
Material	Metal
IP Rating	IP20
Dimmable	No

SKU	Watt	OutputVoltage	Current	Dimension
6131	60W	DC: 12V	5A	170x45x38mm
6132	100W	DC: 12V	8.5A	190x48x38mm
6133	150W	DC: 12V	12.5A	207x63x43mm
6134	250W	DC: 12V	20A	228x71x43mm
6135	360W	DC: 12V	30A	228x71x43mm
6161	60W	DC: 24V	2.5A	170x45x38mm
6162	100W	DC: 24V	4.2A	190x48x38mm
6163	150W	DC: 24V	6.25A	207x63x43mm
6164	250W	DC: 24V	10.5A	228x71x43mm
6165	360W	DC: 24V	15A	228x71x43mm



POWER SUPPLIES 48V	
For Track Lights –Metal	
Input Voltage	220–240V 50/60Hz
Material	Metal
IP Rating	IP20
Dimmable	No

SKU	Watt	OutputV	Current	Dimension
6284	120W	DC: 48V	2.5A	190x90x30mm
6285	250W	DC: 48V	5.2A	220x120x30mm



LEDPOWER SUPPLIES	
Plastic –12V ;24V	
Input Voltage	220–240V 50/60Hz
Material	Plastic
IP Rating	IP20
Dimmable	No

SKU	Watt	OutputVoltage	Current	Dimension
6120	18W	DC: 12V	1.5A	85x50x34mm
6101	24W	DC: 12V	2A	85x50x34mm
6102	36W	DC: 12V	3A	115x47x33mm
6103	60W	DC: 12V	5A	122x55x33mm
6119	80W	DC: 12V	6.5A	136x64x40mm
6141	24W	DC: 24V	1A	85x50x34mm
6142	36W	DC: 24V	1.5A	115x47x33mm
6143	60W	DC: 24V	2.5A	122x55x33mm
6144	80W	DC: 24V	3.3A	136x64x40mm



POWER SUPPLIES 48V	
Waterproof –Metal	
Input Voltage	220–240V 50/60Hz
Material	Metal
IP Rating	IP67
Dimmable	No

SKU	Watt	OutputV	Current	Dimension
6255	150W	DC: 48V	3.125A	–
6256	200W	DC: 48V	4.17A	–

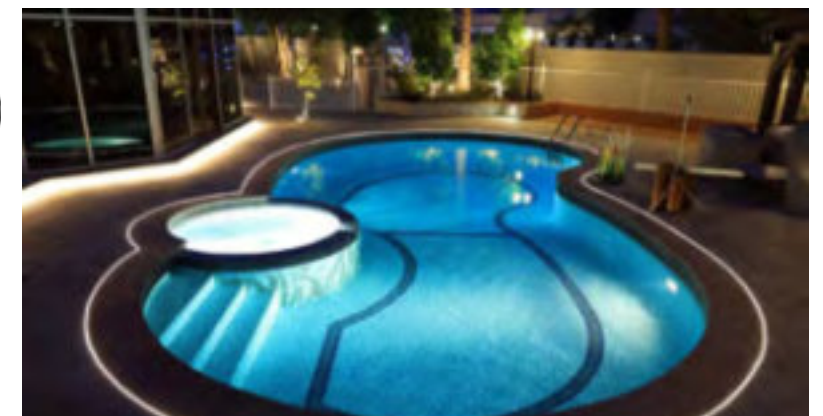



LED REMOTE CONTROLSET
Single Color RF 2.4G 3CH 3x4A V3

LED Remote		LED Receiver	
Output signal	RF 2.4GHz	Input voltage	12/24VDC
Working voltage	3VDC(CR2032)	Output power	144W/288W
Standby time	12 months	Output current	3CH,4A/CH
Remote distance	30m	IP Rating	IP20
Dimension	107x58.5x9mm	Dimension	97x33x18mm

Professionalseries

SKU 6348



CCT RF CONTROLLER
Iron shell RF433M wireless 8-keytouch

Working voltage:	DC 12-24V
Operatig temperature:	-20°C +60°C
Output current /power:	10A*2CH, 12V <240W, 24V <480W
Weight:	140gr
Product size:	L85xW62xH20mm

SKU 6583



LED REMOTE CONTROLSET
RGB -RF 2.4G 3CH 3x4A V3

LED Remote		LED Receiver	
Output signal	RF 2.4GHz	Input voltage	12/24VDC
Working voltage	3VDC(CR2032)	Output power	144W/288W
Standby time	12 months	Output current	3CH,4A/CH
Remote distance	30m	IP Rating	IP20
Dimension	107x58.5x9mm	Dimension	97x33x18mm

Professionalseries

SKU 6349



Remote Holder for 6359 , 6360
SKU 6334

LED RGB CONTROL
Touch -1 Zone RGB -RF 2.4G 3CH 3x4A V3

- Match with OPTONICAProfessional LEDControllers.
- Ultra sensitive color adjustment touchslide.
- Each remote can match one or more receivers.
- Operate with LEDIndicator light.
- Magnet on the back which can be easily stuck on any metal surfaces
- CR2032 battery powered.

Professionalseries Single Color RGB
SKU 6359 6360



RGB+CCTLED STRIP CONTROLLER KIT
5Channels Constant Voltage

- 5 Channels constant voltage output for RGB+CCT light
- Ultra sensitive color adjustment touch wheel
- Smooth dimming and switch without any flickering
- Built in 10 dynamic mode, include jump or gradual change style
- Independent dimming function of each R, G, B channel to achieve millions of colors
- Auto-transmitting function: Controller automatically transmit signal to another controller with 30m control distance
- Synchronize on multiple number of controllers
- Light on/off fade time 3s selectable

Professionalseries

SKU 6387



LED RGB +CCT REMOTE CONTROL
Touch -4 Zone RF 2.4 Ghz

- Match with OPTONICAProfessional LEDControllers.
- Ultra sensitive color adjustment touchslide.
- Each remote can match one or more receivers.
- Operate with LEDIndicator light.
- AAAx2 battery powered.
- Dimension 122x53x17.5mm

Professionalseries
SKU 6368



Bluetooth & RF 2CH LED Controller
2Channels-Push Dim -Wireless Control

- Remote control or connected with external push switch to achieve on/off and dimming function
- Ultra sensitive brightness adjustment touch slide
- Smooth dimming and switch without any flickering
- Auto-transmitting function: Controller automatically transmit signal to another controller with 30m control distance
- Synchronize on multiple number of controllers
- Light on/off fade time 3s selectable
- Magnet on the back which can be easily stuck on back holder or any metal surfaces

Professionalseries

SKU 6386



LED CCT REMOTE CONTROL
Touch -4 Zone RF 2.4Ghz

- Match with OPTONICAProfessional LEDControllers.
- Ultra sensitive color adjustment touch wheel.
- Each remote can match one or more receivers.
- Operate with LEDIndicator light.
- AAAx2 battery powered.
- Dimension 122x53x17.5mm

Professionalseries
SKU 6350





Wall Mounted Holder for 6345

SKU 6347



LED RGB/RGBW REMOTE CONTROL

4ZoneRF 2.4GHz

- Match with OPTONICA Professional LED Controllers.
- Ultra sensitive color adjustment touch wheel.
- Each remote can match one or more receivers.
- Operate with LED Indicator light.
- AAx2 battery powered.
- Dimension 122x53x17.5mm

Professional Series

SKU 6345



SMART Wifi-BLE MUSIC CONTROLLER

IR 44 Keys RGB

- Input Voltage DC12-24V
- Output 3Channels
- Output Current 2A (each channel)
- Output Power 12V-72W; 24V-144W
- Dimension 70x30x15 mm

• Support remote/local control through 2G /3G /4G/Wi-Fi networks.

SKU 6336



LED RGB/RGBW REMOTE CONTROL

4ZoneRF 2.4GHz

- Match with OPTONICA Professional LED Controllers.
- Ultrasensitive color adjustment touch wheel.
- Each remote can match one or more receivers.
- Slim and light
- CR2032 battery powered.
- Dimension 107x58.5x9mm

Professional Series

SKU 6335



SMART Wifi-BLE CONTROLLER

IR 24 Keys RGB CCT

- Input Voltage DC12-24V
- Output 5Channels
- Output Current 1A (each channel)
- Output Power 12V-60W; 24V-120W
- Dimension 70x30x15 mm

• Support remote/local control through 2G /3G /4G/Wi-Fi networks.

SKU 6337



Wall Mounted Holder for 6341; 6340

SKU 6346



LED REMOTE CONTROL

4ZoneSingle Color RF 2.4GHz

- Match with OPTONICA Professional LED Controllers.
- Each remote can match one or more receivers.
- Slim and light
- IP20
- CR2032 battery powered.
- Dimension 135x40x11mm

Professional Series

SKU 6341



SMART Wifi-BLE CONTROLLER

IR 14 Keys CCT

- Input Voltage DC12-24V
- Output 2Channels
- Output Current 2A (each channel)
- Output Power 12V-48W; 24V-96W
- Dimension 70x30x15 mm

• Support remote/local control through 2G /3G /4G/Wi-Fi networks.

SKU 6338



LED REMOTE CONTROL

1ZoneCCT RF 2.4GHz

- Match with OPTONICA Professional LED Controllers.
- Each remote can match one or more receivers.
- Slim and light.
- IP20
- CR2032 battery powered.
- Dimension 107x58.5x9mm

Professional Series

SKU 6340



LED CONTROLLER

IR 40 Keys RGBW

- Input Voltage DC12-24V
- Output 4Channels
- Output Current 2A (each channel)
- Output Power 12V-96W; 24V-192W
- Dimension 70x30x15 mm

SKU 6339





WALL MOUNTED TOUCH PANEL
4Zone/ColorWheel/AC Input/DMX512 Signal

Input Voltage 100-240VAC
Input Current 0.1A
Output Signal DMX512,RF2.4Ghz

- Touchpanel 4 zone 1-4 color DMX512 master, can also be used as 4zone1-4color RF remote.
- DMXsignal output, comply to standard DMX512 protocol, compatible with DMX decoder from any supplier.
- Ultra sensitive high strength glass touch panel with touch color wheel in the middle.
- Touchkeys with LED indicator.

Professionalseries
SKU 6376



ULTRATHIN RF REMOTE CONTROLLER
4ZoneRGB+CCT/TouchColor Wheel

- Apply to RGB+CCT LED controller.
- Ultra sensitive color adjustment touch wheel.
- Each remote can match one or more receiver.
- CR2032 battery powered.
- Operate with LED indicator light.

Professionalseries
SKU 6381



WALL MOUNTED TOUCH PANEL
4Zone/ColorWheel/AC Input/DMX512 Signal

Input Voltage 100-240VAC
Input Current 0.1A
Output Signal DMX512,RF2.4Ghz

- Touchpanel 4 zone 1-4 color DMX512 master, can also be used as 4zone1-4color RF remote.
- DMXsignal output, comply to standard DMX512 protocol, compatible with DMX decoder from any supplier.
- Ultra sensitive high strength glass touch panel with touch color wheel in the middle.
- Touchkeys with LED indicator.

Professionalseries
SKU 6377



ULTRATHIN RGB/RGBW CONTROLLER
1and4zone RGB or RGBW/Touchcolorwheel

- Apply to RGB or RGBW controller.
- Ultra sensitive color adjustment touch wheel.
- Each remote can match one or more receiver.
- CR2032 battery powered.
- Operate with LED indicator light.

Professionalseries
SKU 6344



LED REMOTE CONTROL
Single Color Touch-2.4 GHz

- Touchpanel 4zone1colorRF remote.
- Each zone can remotecontrol multiple receivers, LED controller, dimmingdriver or smart lamp.
- Ultra sensitive high strengthglass touch panel with touch color slide in the middle.
- Smooth and accurate adjustment bytouching theslide.
- Touch keys with chord tones and LED indicator.
- Free installation, no wiring, removable.
- AAA x 2 battery powered.

Professionalseries
SKU 6375



DESK MOUNT RF REMOTE CONTROLLER
Rotary Dimming/CR2032Battery

Output signal RF(2.4GHz) Standby current <10µA
Working voltage 3VDC(CR2032) Standby time 1year
Working current <5mA Remote distance 30m

- Apply to RGB LEDcontroller.
- Rotate knobto change RGB color, color temperature or brightness, support long press or twice click operation.
- Each remote can match one or more receiver.
- CR2032 battery powered.
- Desk mount, removeable anywhere easily.

Professionalseries
SKU 6379



LED Remote Control
RGB /RGBW Touch -2.4 GHz

- Touchpanel 4zone1colorRF remote.
- Each zone can remotecontrol multiple receivers, LED controller, dimmingdriver or smart lamp.
- Ultra sensitive high strengthglass touch panel with touch color slide in the middle.
- Smooth and accurate adjustment bytouching theslide.
- Touch keys with chord tones and LED indicator.
- Free installation, no wiring, removable.
- AAA x 2 battery powered.

Professionalseries
SKU 6374



ROTATED DIMMER
Rotary Dimming8A

Input Voltage DC12-24V
Output 1Channels
Output Current 8A
Output Power 12V-96W; 24V-192W
Dimension 105x63x55 mm

Professionalseries
SKU 6316



BLUETOOTH&RF 2CH LEDCONTROLLER
2Channels/Puch-Dim/Wireless control

Input Voltage	12-36VDC	Output Current	2CH,5A/CH
Input Current	10.5A	Output Power	2x(60-180)W
Output Voltage	2X(12-36)VDC	Output Type	Constant Voltage

- Used for control single color or color temperature LEDstrip.
- Tuya APP cloud control, support on/off, color temperature and brightness adjust, delay turn on/off light,
- Each controller can also work as Bluetooth-RF converter, then use TuyaAPP to control one or more RF LEDcontroller or RF LEDdimming driver synchronously.

Professionalseries
SKU 6384



WiFi & 5in1 LED Controller
Tuya APP Cloud control/Voice control 5CH

Input Voltage	12-24VDC	Output Current	5CH,3A/CH
Input Current	15.5A	Output Power	5x(36-72)W
Output Voltage	5X(12-24)VDC	Output Type	Constant Voltage

- 5 in 1 function, used for control RGB, RGBW, RGB+CCT, color temperature or single color LEDstrip.
- Voice control, support amazon ECHO and TmallGenie smart speaker.
- Match with RF 2.4G remote control optional.
- Light on/off fade time 3s selectable.

Professionalseries
SKU 6383



CONSTANT VOLTAGE LED CONTROLLER
4CH /Wireless remote control /Synchronize

Input Voltage	12-36VDC	Output Current	4CH,5A/CH
Input Current	20.5A	Output Power	4x(60-180)W
Output Voltage	4X(12-36)VDC	Output Type	Constant Voltage

- When using with RGB/RGBW light, built in 10 dynamic mode, include jump or gradual change style.
- Auto-transmitting function: Controller automatically transmit signal to another controller with 30m control distance.
- Synchronize on multiple number of controllers.
- Fade in and out effect selectable.

Professionalseries
SKU 6380



CONSTANT VOLTAGE POWER REPEATER
4CH /PWM signal input

Input Voltage	12-36VDC	Output Current	4CH,5A/CH
Input Current	20.5A	Output Power	4x(60-180)W
Output Voltage	4X(12-36)VDC	Output Type	Constant Voltage

- Waterproof 12-36V constant voltage power repeater with IP67 rating, suitable for outdoor and damp environment.
- 4 channel, 5A per channel.
- To receive PWM signal control.
- Power repeater in series or in parallel to expand output unlimitedly.
- Apply to single color, dual color, RGB or RGBW constant voltage LED strip or module.

Professionalseries
SKU 6395



6 CHANNEL DMX SLIDING FADER
6 Sliding Faders /Real DMX Value LED Screen

- Ideal Cost Efficient 6 Channel Mini DMX Fader Console
- Easy Usage
- Suitable for permanent installations by using available brackets
- Ideal for Sample Testing and Trouble-Shooting on-site or workshops
- Powered by 3 x AAA Batteries or external 5-12V Power-Supply
- 3 Digit LED Screen 0-100% or DMX000-DMX255 (Settings by internal DIP-Switch)
- 6 Channel Mode or 5 Channel & Master Mode (Settings by internal DIP-Switch)

Professionalseries
SKU 6392



CONSTANT VOLTAGE DMX512 & RDM DECODER
Linear or logarithmic dimming /Numeric display

- Comply with the DMX512 standard protocols.
- Digital numeric display, set DMX decode start address by buttons.
- RDM function can realize intercommunication between
- DMX decoder address can be set by DMX master console.
- 1/2/4 DMX channel output selectable.
- 16bit (65536 levels) /8bit (256 levels) grey level selectable.
- Stand-alone RGB/RGBW mode and 4 channel dimmer mode selectable, which be controlled by buttons with built-in programs, instead of DMX signal.

Professionalseries
SKU 6390



4WAYS DMX SIGNAL SPLITTER
DMX512-4 Compatible

- One DMX512 signal input, repeat four DMX512 signal output, each allowing for 32 DMX devices to be connected.
- Dedicated to amplify, distribute and insulate the signal that comes from the lighting system equipment when it is connected to the bus of DMX512 (or RS-485).
- Input isolated from outputs to 500VAC, 1000VDC.
- Outputs are isolated from each other to 500VAC, 1000VDC.
- Input and outputs are true RS-485 rated, and no microprocessors are used for maximum reliability.

Professionalseries
SKU 6391



CONSTANT VOLTAGE POWER REPEATER
5CH /PWM signal input

Input Voltage	12-24VDC	Output Current	5CH 5A
Output Voltage	12-24VDC	Output Power	300-600W

- 12-24V constant voltage power repeater.
- 5 channel, 5A per channel.
- To receive PWM signal control.
- Power repeater in series or in parallel to expand output unlimitedly.
- Apply to RGB+CCT constant voltage LED strip or module.

Professionalseries
SKU 6396



CONSTANT VOLTAGE POWER REPEATER
1 Channels / PWM signal input

Input Voltage	12-24VDC	Output Current	15A
Input Current	15.5A	Output Power	180-360W
Output Voltage	12-36VDC	Output Type	Constant Voltage

- 12-24V constant voltage power repeater.
- One channel, 15A.
- To receive PWM signal control.
- Power repeater in series or in parallel to expand output unlimitedly.
- Apply to single color constant voltage LED strip or module.

Professionals Series
SKU 6393



LED CONTROLLER
4Channel x300mA Constant Current

Output Type	Constant Current	Output Voltage	4x(12-48)VDC
Input Voltage	12-48VDC	Output Current	4CH,300mA/CH
Input Current	1.5A	Output Power	4x(3.6-14.4)W

- One RF controller accept up to 10 remotecontrol.
- Build in 10 dynamic mode, include jump or gradual change style.
- Auto-transmitting function: Controller automatically transmit signal to another controller with 30m control distance.
- Synchronize on multiple number of controllers.
- Connect with external push switch to achieve on/off and dimming function.

Professionals Series
SKU 6343



CONSTANT VOLTAGE POWER REPEATER
4CH / 12-60V/PWM signal input

Input Voltage	12-60VDC	Output Current	4CH,5A/CH
Input Current	20A	Output Power	4x(60-300)W
Output Voltage	4X(12-60)VDC	Output Type	Constant Voltage

- 12-60V constant voltage power repeater.
- 3/4 channel, 5A max. per channel.
- To receive PWM signal control.
- Power repeater in series or in parallel to expand output unlimitedly.
- Apply to single color, dual color, RGB or RGBW constant voltage LED strip or module.

Professionals Series
SKU 6394



DMX512 & RDM DECODER
4CH x5A Constant Voltage

Output Type	Constant Voltage	Output Voltage	12-24VDC
Input Voltage	12-24VDC	Output Current	4CH,5A/CH
Input Current	20.5A	Output Power	4x(60-120)W

- Comply with the DMX512 standard protocols.
- Digital numeric display, set DMX address by buttons.
- RDM function can realize intercommunication between DMX master and decoder.
- 1/2/4 DMX channel output selectable.
- Stand-alone RGB/RGBW mode and 4 channel dimmer mode selectable.

Professionals Series
SKU 6364



HIGH VOLTAGE LED STRIP CONTROLLER
3CH / Step-less dimming/Wireless control

Input Voltage	110-240VAC	Output Current	3CH,1A/CH
Input Current	3.2A	Output Power	3x(110-240)W
Output Voltage	3X(110-240)VDC		

- 3 channel high voltage LED strip RF 2.4G controller
- Match with RF 2.4G single zone or multiple zone single color, dual color and RGB/RGBW remote control.
- One RF controller accept up to 10 remotecontrol.
- When using with RGB light, built in 10 dynamic mode, include jump or gradual change style.

Professionals Series
SKU 6397



LED CONTROLLER
5CH X5A

Output Type	Constant Voltage	Output Voltage	5x(12-24)VDC
Input Voltage	12-24VDC	Output Current	5CH,5A/CH
Input Current	25.5A	Output Power	5x(60-120)W

- One RF controller accept up to 10 remotecontrol.
- Build in 10 dynamic mode, include jump or gradual change style.
- Auto-transmitting function: Controller automatically transmit signal to another controller with 30m control distance.
- Synchronize on multiple number of controllers.
- Connect with external push switch to achieve on/off and dimming function.

Professionals Series
SKU 6366



LED CONTROLLER
4CH x5A /RF2.4 GHz +Push

Input Voltage	12-36VDC	Output Current	4CH,5A/CH
Input Current	20.5A	Output Power	4x(60-180)W
Output Voltage	4x(12-36)VDC	Output Type	Constant Voltage

- One RF controller accept up to 10 remotecontrol.
- Build in 10 dynamic mode, include jump or gradual change style.
- Auto-transmitting function: Controller automatically transmit signal to another controller with 30m control distance.
- Connect with external push switch to achieve on/off and dimming function.

Professionals Series
SKU 6342



0/1-10V DIMMING DRIVER
1CH 12A

Input Voltage	12-36VDC	Output Voltage	12-36VDC
Input Current	12.5A	Output Current	1CH,12A
Input Signal	0/1-10V+Push	Output Power	144-432W

- Match with OPTONICA Professional Series Remote Controls.
- 1 channel 0/1-10V LED dimming driver with push-dim function.
- 1 channel 0/1-10V input, 1 channel PWM constant voltage output.
- 0-100% dimming range via logarithmic characteristic can be very comfortable for human eyes.

Professionals Series
SKU 6367



0/1-10V LED DIMMING DRIVER
4CH x 5A

Input Voltage	12-36VDC	Output Voltage	12-36VDC
Input Current	20.5A	Output Current	4CH, 5A/CH
Input Signal	0/1-10V+Push	Output Power	4x(60-180W)

- Match with OPTONICA Professional Series Remote Controls.
- 4 channel 0/1-10V LED dimming driver with push-dim function.
- 4 channel 0/1-10V input, 4 channel PWM constant voltage output.
- 0-100% dimming range via logarithmic characteristic can be very comfortable for human eyes.

Professional Series
SKU 6369



LED CONTROLLER
3CH x 4A

Input Voltage	12-24VDC	Output Voltage	3X(12-24)VDC
Input Current	12.5A	Output Current	3CH, 4A/CH
Input Signal	RF2.4Ghz	Output Power	144/288W

- Match with OPTONICA Professional Series Remote Controls.
- One RF controller accept up to 10 remote control.
- Build in 10 dynamic mode, include jump or gradual change style.
- Auto-transmitting function: Controller automatically transmit signal to another controller with 30m control distance.
- Synchronize on multiple number of controllers.

Professional Series
SKU 6353



DALI LED DIMMER
1CH 15A

Input Voltage	12-24VDC	Output Voltage	12-24VDC
Input Current	15A	Output Current	1CH, 15A
Input Signal	DALI+Push	Output Power	180W/360W

- Match with OPTONICA Professional Series Remote Controls.
- Constant voltage DALI LED dimmer with 1 channel, 15A output.
- DALI address will be automatically assigned by DALI master, 1 DALI address.
- PWM digital dimming, standard DALI logarithmic dimming curve.
- Connect with external push switch to achieve on/off and dimming function.

Professional Series
SKU 6371



LED FADEIN/OUTPUSH DIMMER
1CH x 8A

Input Voltage	12-24VDC	Output Voltage	1X(12-24)VDC
Input Current	8A	Output Current	8A/CH
Input Signal	RF2.4Ghz	Output Power	96/384W

- Fade-in Fade-out LED dimmer with smooth fading effect for soft start and stop.
- The fading speed can be set via knob potentiometer, 1S, 3S, 5S, 10S, 20S selectable.
- Connect with self-resetting metal button or push switch to achieve on/off and 0-100% dimming function.
- Push input can accept either positive or negative trigger.

Professional Series
SKU 6321



DALI LED DIMMER
4CH x 5A

Input Voltage	12-24VDC	Output Voltage	12-24VDC
Input Current	20.5A	Output Current	4CH, 5A/CH
Input Signal	DALI	Output Power	4x(60-120W)

- Match with OPTONICA Professional Series Remote Controls.
- 4 channel constant voltage DALI LED dimmer, 5A per channel.
- 4 DALI address, 4 channel work separately.
- DALI address will be automatically assigned by DALI master.
- PWM digital dimming, standard DALI logarithmic dimming curve.

Professional Series
SKU 6372



LED CONTROLLER
1CH x 8A

Input Voltage	5-36VDC	Output Voltage	1X(5-36)VDC
Input Current	8.5A	Output Current	1CH, 8A
Input Signal	RF2.4Ghz	Output Power	40W/96W/192W/288W

- 4096 levels 0-100% dimming smoothly without any flash.
- One RF controller accept up to 10 remote control.
- Match with RF 2.4G single zone or multiple zone dimming remote control.
- Auto-transmitting function: Controller automatically transmit signal to another controller with 30m control distance.
- Synchronize on multiple number of controllers.

Professional Series
SKU 6322

NEW



AC TRIAC DALI DIMMER
4CH x 5A / RF2.4 GHz + Push

Input Voltage	AC100-240V	Output Voltage	AC100-240V
Dimming Level	256 levels	Output Current	Max 1.5A
		Output Power	150-360W

- AC phase-cut DALI dimmer, one DALI address, one channel output.
- DALI address can be manually assigned and shown in digital display or automatically assigned by DALI master.
- Reverse-phase dimming or forward-phase dimming selectable.
- To dimmable single color dimmable LED lamps, traditional incandescent and halogen lights.

Professional Series
SKU 16302



RGB/RGBW SPI LED CONTROLLER
1CH x 8A

Input Voltage	5-25VDC	Input Signal	Tuya APP + RF 2.4Ghz
Input Current	8A	Output Signal	SPI(TTL)x2

- Multi-pixel RGB/RGBW LED strip controller with SPI signal output, Tuya APP cloud control.
- Voice control, support for Amazon Echo, Google, Tmall Genie and Xiaodu smart speakers.
- Compatible with 45 kinds of RGB or RGBW LED strips.
- Rich dynamic effects: 44 default and 10+ custom dynamic scenarios, 16 variations.
- Match with RF 2.4G RGB remote control.

Professional Series
SKU 6352





LED SINGLE COLOR CONTROLLER
4CH x4A

Input Voltage	12-24VDC	Output Voltage	3x(12-24)VDC
Input Current	12.5A	Output Current	3CH,4A/CH
IP Rating	IP20	Output Power	144-288W
Dimension	86x86x53 mm	Output Type	Constant Voltage

Professionalseries
SKU 6357



LED 0-10VDIMMER
1CH -Rotaryglass panel

Input Voltage	100-240V	OutputSignal	0-10V(50mA)
Dimension	86x86x48 mm	Output Current	1.5A

- Rotary glass panel 1-10Vdimmer,1channeloutput.
- Output connect with 0/1-10Vdimnable driver.
- Output 1 channel 1-10V signal, connect with 1-10V dimmable driver.
- High voltage AC input, High voltage AC relay output.
- Compatibility with RF 2.4G single zone or multiple zone dimmingremote control.

Professionalseries
SKU 6399



LED RGB CONTROLLER
4CH x4A

Input Voltage	12-24VDC	Output Voltage	3x(12-24)VDC
Input Current	12.5A	Output Current	3CH,4A/CH
IP Rating	IP20	Output Power	144-288W
Dimension	86x86x53 mm	Output Type	Constant Voltage

Professionalseries
SKU 6358



LED AC TRIAC DIMMER
1CH -Rotaryglass panel

Input Voltage	100-240V	OutputSignal	150-360W
Dimension	86x86x48 mm	Output Current	Max 1.5A

- Rotary glass panel AC phase-cutdimmer,1channeloutput.
- To dimand switch single color dimmable LED lamps, traditional incandescent and halogenlights.
- 256 levels 0-100% dimmingsmoothly without any flash.
- Leading edge dimmingor trailing edge dimmingset by dip switch.
- Over-heat / Over-loadprotection, recover automatically.

Professionalseries
SKU 6351



LED DMX CONTROLLER
4Zones controlDMX512+RF2.4GHz

Input Voltage	85-265V	Control Mode	4ZoneControl
OutputSignal	DMX512+RF	Light Type	Single Color
IP Rating	IP20	Remote Distance	30m
Dimension	86x86x36 mm	Working Temp.	-20°C/+50°C

Professionalseries
SKU 6361



LED 0-10VDIMMER
4Zones-Touch glass panel

Input Voltage	100-240V	OutputSignal	0-10V(20mA)
Dimension	86x86x33 mm	Output Current	20mA/CH

- Touch panel 0-10V dimmer,output 4 channel 0-10V signal
- Output connect with 0/1-10Vdimnable driver.
- Ultra sensitive high strength glass touch panel with touch slide in the middle.
- Compatibility with RF 2.4G dimmingremote control.
- Touch keys with LED indicator.

Professionalseries
SKU 6398



LED RGBW DMX CONTROLLER
4Zones controlDMX512+RF2.4GHz

Input Voltage	85-265V	Control Mode	4ZoneControl
OutputSignal	DMX512+RF	Light Type	RGBW
IP Rating	IP20	Remote Distance	30m
Dimension	86x86x36 mm	Working Temp.	-20°C/+50°C

Professionalseries
SKU 6362



RGB LED MINI CONTROLLER
3CH -4.5A Output

Input Voltage	12-24VDC	Output Current	3CH,1.5A/CH
Output Voltage	12-24VDC	Output Type	Constant Voltage

- 3 channel constant voltage RGB LEDmini controller.
- 3 key operation with on/off, mode and color adjustment.
- 1.5A per channel,output connectwith 5metersRGBLEDstrip.
- 256 levels 0-100% dimmingsmoothly without any flash.
- Built in 10 dynamic mode,include jump or gradual change style.

Professionalseries
SKU 6378



LED CONTROLLER
4CH x 5A

Input Voltage	12-24VDC	Output Voltage	4x(12-24)VDC
Input Current	20.5A	Output Current	4CH,5A/CH
IP Rating	IP20	Output Power	4x(60-120W)

- Digital numeric display and easy key operation.
- Can set as 1 channel dimmer,4channel,dualcolor,RGBor RGBW controller.
- Logarithmic or linear dimmingcurve selectable.
- Synchronize on multiple numberof controllers.

Professionalseries
SKU 6355



AC TRIAC DIMMER
RF 2.4GHz

Input Voltage	100-240VAC	Output Voltage	100-240VAC
Input Signal	RF2.4GHz+Push	Output Current	1CH,2A/CH
IP Rating	IP20	Output Power	200-480W

- RF+Push AC phase-cut dimmer, 1channel output.
- Digital numeric display , set brightness by bottons.
- 0-100% dimmingsmoothly without any flash.
- Reverse-phase dimmingor forward-phase dimming selectable.
- Minimumbrightness set from1% to 40%

Professionalseries
SKU 6365



POWER REPEATER
4CH x 5A

Input Voltage	12-24VDC	Output Voltage	4x(12-24)VDC
Input Current	20.5A	Output Current	4CH,5A/CH
IP Rating	IP20	Output Power	4x(60-120W)

- To receive PWM signal control.
- Power repeater in serie or in parallel to expandoutput unlimitedly.
- Apply to single color,dual color,RGB or RGBW constant voltage LEDstrip or module.
- 3KV Optoelectronic isolation.

Professionalseries
SKU 6370



WiFi RELAY 2.4GHz
WiFi to RF Converter

Input Voltage	5-24VDC	Output Control	RGB,RGBW,CT
Wifi standard	802.11 b/g/n	Working Temp.	-20°C-50°C
Dimension	ø72x25 mm	Platform	iOS , Android



Professionalseries
SKU 6354

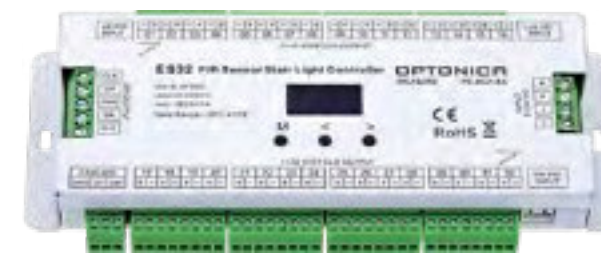

PIR SENSOR STAIR LIGHT CONTROLLER
PIR Sensor /Daylight sensor /Max 32 Step

Input Voltage	5-24VDC	Output Current	32CH,1A/CH
Output Voltage	32 x (5-24)VDC	Output Power	32 x (5-24W)
Output Type	Constant Voltage+SPI(TTL)		

- Multiple function PIR sensor stair light controller with daylight sensor.
- 32 channels constant voltage output drive low voltage LEDstrip, Max. 1A
- Built-in multiple color mode,speed and brightness 1-8 grade adjustable.
- Push switch can also be as induction signal input.
- With fast self-testing function.
- Any damaged LEDchannel in 32 channels can be set disable.

Professionalseries
SKU 6385



DMX512 /0-10VTO TRIAC DIMMER
RDM/Stand-alonefunction/Numeric display

Input Voltage	100-240VAC	Output Current	1CH,6A/CH
Output Voltage	100-240VAC	Output Power	600-1440W

- AC phase-cut mosfet dimmer with DMX512 function, one channel output.
- Comply with the DMX512 standard protocols.
- Digital numeric display, set DMX decode start address by bottons.
- Reverse-phase dimmingor forward-phase dimming selectable.
- Minimumbrightness set from1% to 40%
- Stand-alone dynamic mode and dimmermodeselectable, which be controlled by bottons with built-in programs, instead of DMX signal.

Professionalseries
SKU 6389



HIGH VOLTAGE DMX 512 DECODER
3CH /RDM Stand-alone function /Numeric display

Input Voltage	100-240VAC	Output Current	3CH,1.5A/CH
Output Voltage	100-240VAC	Output Power	3x(165-360W)

- Comply with the DMX512 standard protocols.
- Digital numeric display, set DMX decode start address by bottons.
- RDM function can realize intercommunication between DMX master and decoder
- 1/3 DMX channel output selectable.
- PWM frequency 1000/2000/4000/8000Hzselectable.
- Logarithmic or linear dimmingcurve selectable.
- Match with RF 2.4G single zone or multiple zone RGB remote control optional.

Professionalseries
SKU 6330



LED CONTROLLER
3CH X10A

Input Voltage	12-36VDC	Output Voltage	3x(12-36)VDC
Input Current	30.5A	Output Current	3CH,10A/CH
Input Signal	RF2.4GHz	Output Power	3x(120-360W)

- One RF controller accept up to 10 remotecontrol.
- Build in 10 dynamic mode,include jumpor gradual change style.
- Auto-transmitting function: Controller automatically transmit signal ot another controller with 30mcontrol distance.
- Synchronize on multiple numberof controllers.

Professionalseries
SKU 6356



RF SIGNAL REPEATER
AC or DC input /Wall junction box mounting

Input Voltage 12-24VDC; 100-240VAC
Input/Output RF 2.4GHz RF Control Distance 30m

- Apply for wireless signal extension, greatly ensures RF communication stability and wide controlling area.
- Powered by AC100-240V or DC12-24V.
- Compatibility with RF 2.4G remote control.
- Easy to be placed in standard wall junction box.

Professionalseries
SKU 6382



POWER REPEATER
5 CH x5A

Input Voltage 12-24VDC Output Current 5CH 5A
Output Voltage 12-24VDC Output Power 300-600W

- 12-24V constant voltage power repeater.
- 5 channel, 5A per channel.
- To receive PWM signal control.
- Power repeater in series or in parallel to expand output unlimitedly.
- Apply to RGB+CCT constant voltage LED strip or module.

Professionalseries
SKU 6373



WiFi & RF TRIAC DIMMER
Voice Control/RF Dimming/PushDim

Input Voltage AC100-240V Output Current MAX 1.5A
Output Voltage AC100-240V Output Power 150-360W

- WiFi +RF +Push AC phase-cut dimmer, 1 channel output.
- Voice control, support amazon ECHO and TmallGenie smart speaker.
- 256 levels 0-100% dimming smoothly without any flash.
- Compatibility with RF 2.4G single zone or multiple zone dimming remote control.
- Easy to be placed in standard wall junction box behind a push switch.
- Over-heat / Over-load protection, recover automatically.

Professionalseries
SKU 6388



SINGLE COLOR LED CONTROLLER
1CH x20A

Input Voltage 12-48VDC Output Current 1CH 20A
Output Voltage 12-48VDC Output Power 240-480W

- RF remote, 0/1-10V, Push Dim (3-in-1) dimming.
- Match with RF 2.4G single zone or multiple zone dimming remote control.
- One RF controller accept up to 10 remote control.
- Synchronize on multiple number of controllers.
- Connect with external push switch to achieve on/off and 0-100% dimming function.
- Over-heat / Over-load / Short circuit protection, recover automatically.

Professionalseries
SKU 16301



AC TRIAC RF DIMMER
RF 2.4 GHz +Push

Input Voltage 100-240VAC Output Voltage 100-240VAC
Input Signal RF 2.4GHz+Push Output Current MAX 1A
IP Rating IP20 Output Power 100-240W

- Match with OPTONICA Professional Series Remote Controls.
- RF+Push AC phase-cut dimmer, 1 channel output.
- 0-100% dimming smoothly without any flash.
- Connect with external push switch to achieve ON/OFF and dimming function.
- Easy to be inserted into standard 86x86mm wall box.

Professionalseries
SKU 6363

NEW



AC TRIAC RF DIMMER
RF 2.4 GHz +Push

Input Voltage 100-240VAC Output Voltage 100-240VAC
Input Signal RF 2.4GHz+Push Output Current MAX 1A
IP Rating IP20 Output Power 100-240W

- Match with OPTONICA Professional Series Remote Controls.
- RF+Push AC phase-cut dimmer, 1 channel output.
- 0-100% dimming smoothly without any flash.
- Connect with external push switch to achieve ON/OFF and dimming function.
- Easy to be inserted into standard 86x86mm wall box.

Professionalseries
SKU 16305

NEW



RF TO 1CH LED DIMMER
0/1-10V RF +Push

Input Voltage 100-240VAC Output Signal 0/1-10V (20mA)
Input Signal RF 2.4GHz+Push Output Current MAX 3AAC
IP Rating IP20 Relay surge current 200A

- 0/1-10V RF or AC push dimmer, 1 channel output.
- Output 1 channel 0/1-10V signal, connect with 0/1-10V dimmable driver.
- High voltage AC input, high voltage AC relay output, with zero-crossing detection.
- 0-10V or 1-10V output selectable by DIP switch.
- 256 levels 0-100% dimming smoothly without any flash.
- Connect with external push switch to achieve on/off and 0-100% dimming function.

Professionalseries
SKU 16303

NEW



Wireless Remote Control Switch
3Way LED-200W

Power LED 3x200W Range 0-15M
Input Voltage 220-240VAC Dimension 42x110mm
IP Rating IP20 Remote Control YES

- This product is a remote control switch for lighting fixtures, which can be remotely controlled and has a wide range of applications. It can be used for various lighting products.

SKU 16304



LEDSTRIP DIMMER
With Remote control 8 A

Power 96W-192W
Output Current 8A
Voltage 12V / 24V
IP Rating IP20
Dimension 80x55x30mm

SKU 6302



WiFi CONTROLLER
RGB /Single Color 3x4A

Power	90W-288W	90W-288W
Output Current	12A	12A
Voltage	7.5V-24V	7.5V-24V
IP Rating	IP20	IP20
Strip Type	RGB	Single Color
Dimension	80x55x30mm	80x55x30mm

SKU 6310 6311



LED STRIP REMOTE CONTROL
RGB -4 Buttons 3x4A

Power 144W-288W
Output Current 3x4A
Voltage 12V / 24V
IP Rating IP20
Dimension 105x65x20mm

SKU 6304



AMPLIFIER FOR LEDSTRIPS
RGB -Iron shell 3x8A

Power 288W-576W
Output Current 3x8A
Voltage 12V / 24V
IP Rating IP20
Dimension 80x70x30mm

SKU 6326



LED STRIP REMOTE CONTROL
RGB -16 Buttons 3x2A

Power 72W
Output Current 3x2A
Voltage 12V
IP Rating IP20
Dimension 50x35x20mm

SKU 6303



AMPLIFIER FOR LEDSTRIP
RGB -WHITE 4x6A

Power 288W-576W
Output Current 4x6A
Voltage 12V-24V
IP Rating IP20
Dimension 66x55x20mm

SKU 6328



LED STRIP REMOTE CONTROL
RGB -44 Buttons

Power	72W	144W
Output Current	6A	12A
Voltage	12V	12V
IP Rating	IP20	IP20
Dimension	50x35x20mm	50x35x20mm

SKU 6306 6307



AMPLIFIER FOR LEDSTRIP
RGB 3x4A

Power 144W-288W
Output Current 3x4A
Voltage 12V-24V
IP Rating IP20
Dimension 106x64x23.5 mm

SKU 6305



NEW





KINETICSET				
Remote Control Switch & Controller				
Input Voltage	AC110-240V50Hz	Material	Plastic	
Input Voltage	433Mhz	On/Off Cycles	100000x	
Maximum Load	600W(Each gang)	IP Rating	IP20	
	1-GANG		2-GANG	
SKU	7651	7652	7653	7654
Color	White	Black	White	Black



LED STRIP REMOTE CONTROL		
RGB Touch 3x6A White / Black		
Power	216W-432W	216W-432W
Output Current	3x6A	3x6A
Voltage	12V / 24V	12V / 24V
IP Rating	IP20	IP20
Body Color	White	Black
Dimension	95x50x30mm	95x50x30mm
SKU	6314	6315

NEW



KINETIC SET -WiFi ,TUYA App				
Remote Control Switch & Controller				
Input Voltage	AC110-240V50Hz	Material	Plastic	
Input Voltage	433Mhz	On/Off Cycles	100000x	
Maximum Load	150W(Each gang)	IP Rating	IP20	
	1-GANG			
SKU	7655	7656	 	
Color	White	Black		



LED STRIP REMOTE CONTROL		
RGBW Touch4x6A		
Power	288W-576W	
Output Current	4x6A	
Voltage	12V / 24V	
IP Rating	IP20	
Dimension	80x45x15mm	
SKU	6329	



SENSOR DIMMER		
Wall Mounted 10A		
Power	120W-240W	
Output Current	10A	
Voltage	12V / 24V	
IP Rating	IP20	
Body Color	White	
Dimension	85x85x40mm	
SKU	6320	6318
Color	White	Black



MUSIC LED CONTROLLER	
With Remote control 3x4A	
Power	144W-288W
Output Current	3x4A
Voltage	12V-24V
IP Rating	IP20
Dimension	170x85x23mm
SKU	6312



SENSOR DIMMER		
Wall Mounted RGB 3x4A		
Power	120W-240W	
Output Current	3x4A	
Voltage	12V / 24V	
IP Rating	IP20	
Body Color	White	
Dimension	85x85x40mm	
SKU	6319	6317
Color	White	Black



DMX512 DECODER	
3x4A	
Power	144W-288W
Output Current	3x4A
Voltage	12V-24V
IP Rating	IP20
Dimension	160x60x42mm
SKU	6308

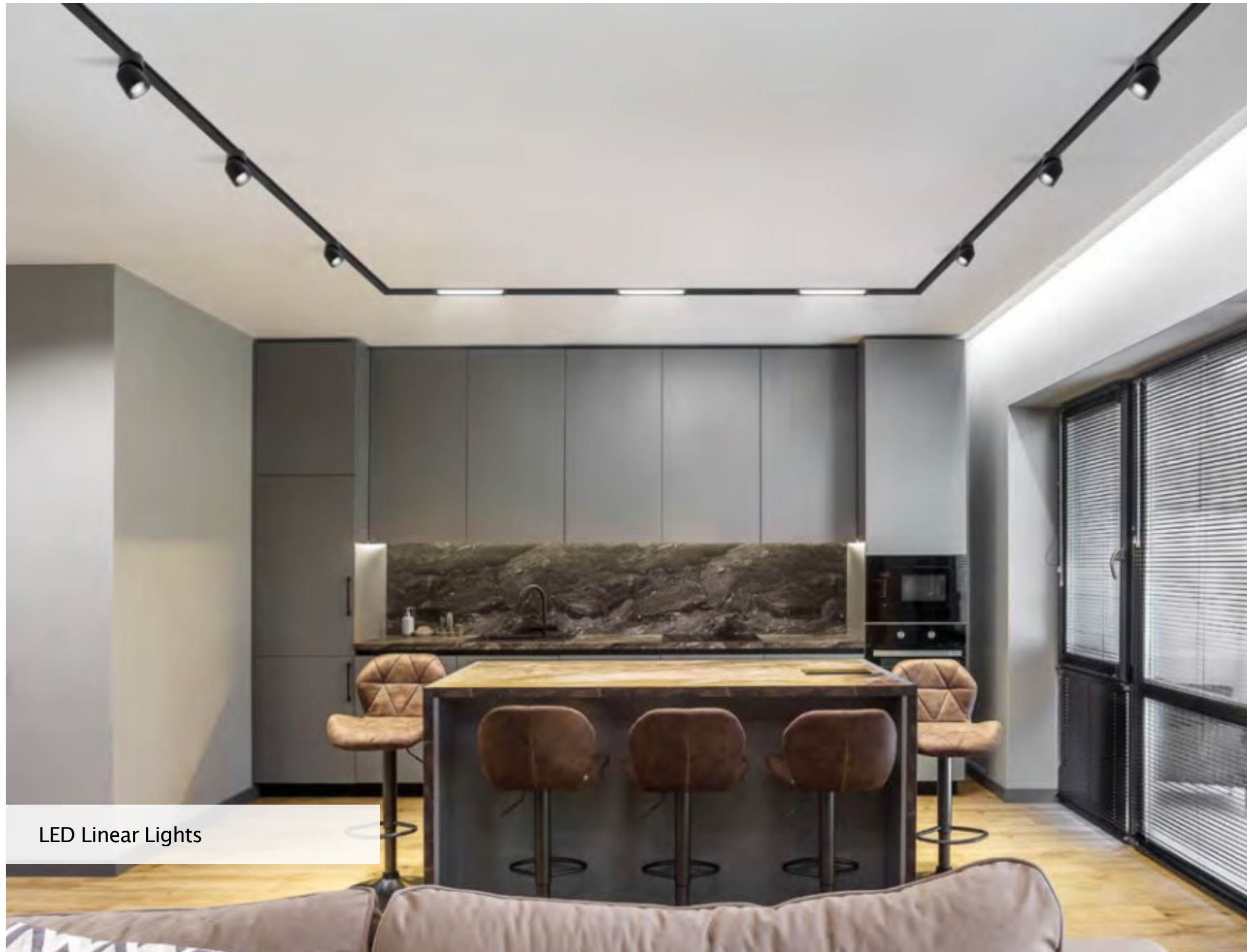

LED Linear Lights

LED linear and track lights are highly specialized luminaires, designed to deliver concentrated light distribution for retail, galleries, and other presentation spaces. With adjustable fixtures and versatile three-phase track systems, they adapt seamlessly to different layouts — from elegant showrooms to large-scale trade fair halls and shopping malls.

Features:

- Available in multiple colour temperatures to suit diverse display needs
- Up to 80% energy savings compared to conventional lighting
- Adjustable, modular design for flexible layouts
- Quick and secure installation with foolproof connectors
- Durable construction for long-term use

Applications:

- Retail stores, supermarkets, and shopping malls
- Showrooms, exhibition halls, and trade fairs
- Art galleries and museums
- Stylish accent lighting for dining rooms or residential interiors
- Popular for both commercial and decorative projects

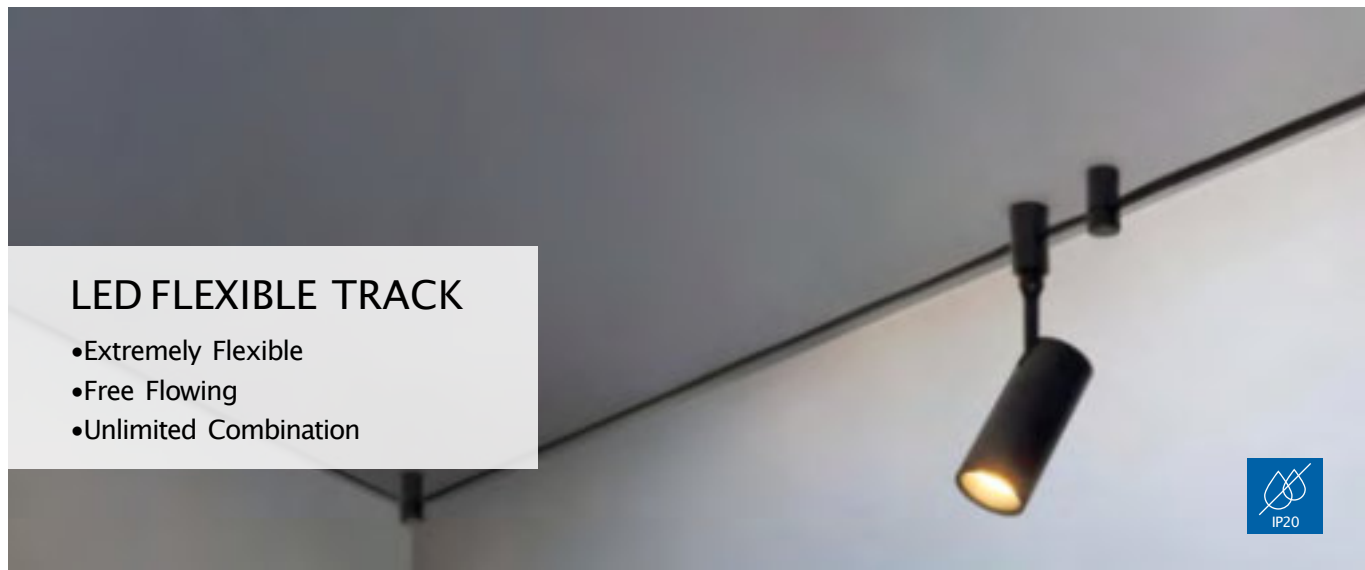

LED FLEXIBLE TRACK

- Extremely Flexible
- Free Flowing
- Unlimited Combination



SKU 15401
Color Black
Set includes:
5m flexible track, 2 spotlights, 1 linear light,
1 power supply with box, mounting hardware

LED Flexible Track (Colour Bridge)			
DIYSET V1			
Input Voltage	DC:48V	Beam Angle	36°
Spot Power	7W	Spot Lumens	390lm
Linear Power	40W	Linear Lumens	2000lm
Beam Angle	36°	Dimmable	No



SKU 15402
Color White
Set includes:
5m flexible track, 3 spotlights,
1 power supply with box, mounting hardware

LED Flexible Track (Colour Bridge)			
DIYSET V2			
Input Voltage	DC:48V	Beam Angle	36°
Spot Power	7W	Spot Lumens	390lm
Beam Angle	36°	Dimmable	No



LED LINEAR LIGHT



LED LINEAR LIGHT - SLIM	
PREMIUM LINE	
Ceiling mounting or cable suspension	
Power	40W
Input Voltage	220-240V 50/60Hz
Beam Angle	120°
CRI	Ra>80
IP Rating	IP20
Dimension	1200x50x70mm

SKU	Body	Lumen	Colour
5472	White	4000lm	6000K
5382	White	4000lm	4000K
5470	Black	4000lm	6000K
5380	Black	4000lm	4000K
5471	Gray	4000lm	6000K
5381	Gray	4000lm	4000K



ACCESSORIES					
White	White	Black	Black	Grey	Grey
SKU 5062	5029	5060	5027	5061	5028
Color 6000K	4000K	6000K	4000K	6000K	4000K

White	White	Black	Black	Grey	Grey
SKU 5065	5037	5063	5030	5064	5036
Color 6000K	4000K	6000K	4000K	6000K	4000K

White	White	Black	Black	Grey	Grey
SKU 5068	5040	5066	5038	5067	5039
Color 6000K	4000K	6000K	4000K	6000K	4000K

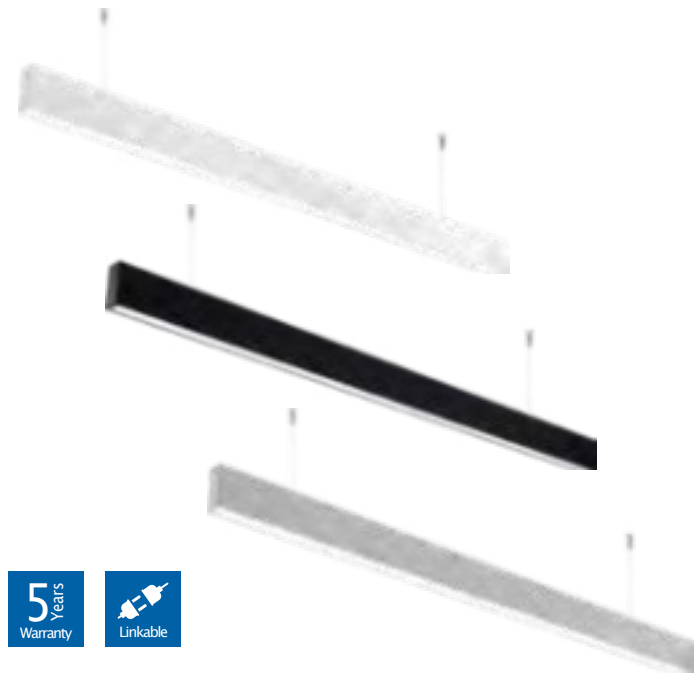

	White	Black	Gray
SKU	5385	5383	5384
Color	4000K	4000K	4000K

LED LINEAR LIGHT
PREMIUM LINE
UP & DOWN-LINKABLE

Power	50W	Beam Angle	120°
Input Voltage	AC220-240V 50Hz	CRI	Ra>80
Lumens	5000lm	IP Rating	IP20
Size	1200x72x30mm	Dimmable	No



	White	Black	Silver	Wood	Champagne
SKU	16772	16771	16773	16774	16775
Color	CCT	CCT	CCT	CCT	CCT

LED LINEAR LIGHT 3CCT
COLORPLASTIC SERIES

Power	38W	Beam Angle	120°
Input Voltage	AC220-240V 50Hz	CRI	Ra>80
Lumens	3800lm	IP Rating	IP20
Size	1200x70x35mm	Dimmable	No

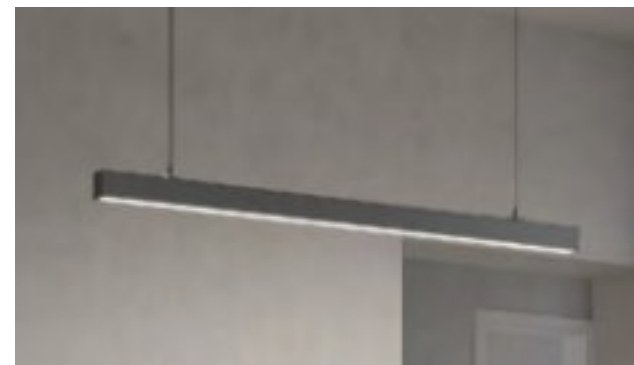

	White	Black	Gray
SKU	5388	5386	5387
Color	4000K	4000K	4000K

5047 Connector

LED LINEAR LIGHT
PREMIUM LINE
UGR<19-LINKABLE

Power	50W	Beam Angle	60°
Input Voltage	AC220-240V 50Hz	CRI	Ra>80
Lumens	4500lm	IP Rating	IP20
Size	1185x68x40mm	Dimmable	No



	White	Black
SKU	5478	5479
Color	4000K	4000K

65316 Suspension Kit for Linear Lights

LED LINEAR LIGHT
NON-LINKABLE

Power	40W	Beam Angle	120°
Input Voltage	AC220-240V 50Hz	CRI	Ra>80
Lumens	4400lm	IP Rating	IP20
Size	1200x60x57mm	Dimmable	No



NEW

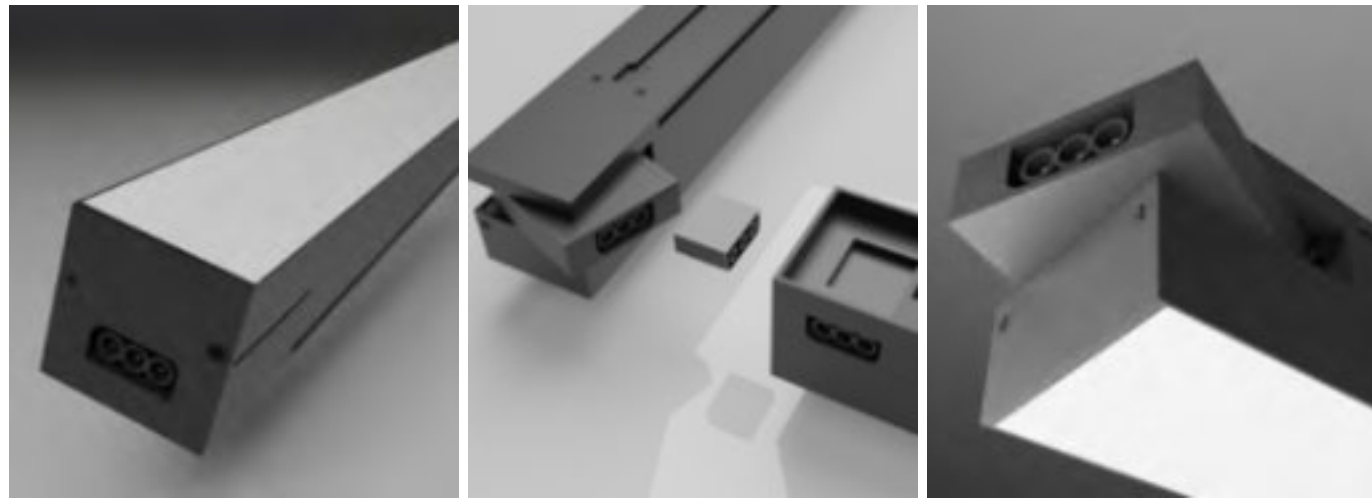

LED LINEAR LIGHT 3CCT	
LINKABLE	
Input Voltage	170-265V 50/60Hz
Beam Angle	120°
CRI	Ra>80
IP Rating	IP20
Dimmable	No

SKU	Watt	Lumen	Lumen/W	Color	Dimension
16761	24W	2400lm	100lm/W	3CCT	600x55x55mm
16762	36W	3600lm	100lm/W	3CCT	900x89x19.5mm
16763	50W	5000lm	100lm/W	3CCT	1200x89x19.5mm

ACCESSORIES

SKU 16764 Hanging Accessories



SKU 16765 Installation Accessories



SKU 16766 Exposed Mounting



SKU 16767 Input Cable 0.3m



SKU 16768 Input Cable 1.5m

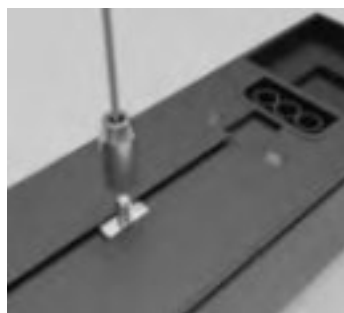

NEW



HEXAGON SET LIGHTS	
LINKABLE	
Input Voltage	165-265V 50/60Hz
Beam Angle	120°
CRI	Ra>80
IP Rating	IP20
Dimmable	No



SKU	Watt	Lumen	Nu	Color	Dimension
16801	42W	5040lm	1 HEX	6000K	790x920mm
16802	192W	23040lm	5 HEX	6000K	1580x2290mm
16803	280W	33600lm	8 HEX	6000K	2370x2290mm
16804	385W	46200lm	11 HEX	6000K	2290x3150mm
16805	456W	54720lm	14 HEX	6000K	2430x4835mm

SKU 16814 V-CONNECTOR



SKU 16815 L-CONNECTOR



SKU 16816 Y-CONNECTOR



SKU 16817 T-CONNECTOR



SKU 16818 X-CONNECTOR



SKU 16819 LINE-CONNECTOR



SINGLE LIGHTS FOR DIYSET



SKU	Watt	Lumen	Lumen/W	Color	Dimension
16811	7W	840lm	120lm/W	6000K	440mm
16812	9W	1080lm	120lm/W	6000K	570mm
16813	INPUT CABLE 0.5M				

NEW



SKU 16752
Link Connector

SKU 16751
Color 4000K



LED LINEAR FIXTURE

Linkable			
Power	50W	Beam Angle	
Input Voltage	AC220-240V 50Hz	CRI	120°
Lumens	9500lm	IP Rating	Ra>80
Size	1605x94x84mm	Dimmable	IP20 No



	White	White	Black	Black
SKU	5007	5008	5009	5010
Size	1m	2m	1m	2m

TRACKSYSTEM

3Phases/4Wires-including connection and end piece

Input Voltage	AC220-240V50Hz	IP Rating	IP20
Size	1000x40x35mm	Material	ALU



TRACKSYSTEM

1Phases/2Wires

Input Voltage	AC220-240V50Hz	IP Rating	IP20
Size	1000x40x20mm	Material	ALU



	White	White	Black	Black
SKU	5153	5156	5154	5155
Size	1m	2m	1m	2m



SKU 5157
Straight Connector White



SKU 5159
Straight Connector Black



SKU 5158
Angle Connector White



SKU 5160
Angle Connector Black



SKU 5049
Suspension for 3-Phase Tracks



SKU 5048
Suspension for 3-Phase Tracks



SKU 5059
Adapter for 3-Phase Tracks



SKU 5069
Adapter for 3-Phase Tracks



SKU 5019
L-Feeder White



SKU 5020
L-Feeder Black



SKU 5013
Straight Connector White



SKU 5014
Straight Connector Black



SKU 5011
Mini Straight Connector White



SKU 5012
Mini Straight Connector Black



SKU 5015
L-Connector White



SKU 5016
L-Connector Black



SKU 5017
T-Connector White



SKU 5018
T-Connector Black



SKU 5021
X-Connector White



SKU 5022
X-Connector Black



SKU 5025
Flexible Connector White



SKU 5026
Flexible Connector Black



SKU 5023
End Cap For Track White



SKU 5024
End Cap For Track Black

NEW



	White	White	Black	Black
SKU	15103	15104	15101	15102
Color	4000K	2700K	4000K	2700K

bridgelux

LED COB TRACK LIGHT

For 1Phase Track System

Power	12W	Beam Angle	24°
Input Voltage	AC220-240V 50Hz	CRI	Ra>80
Lumens	1200lm	IP Rating	IP20
Size	ø50x130mm	Dimmable	No



3 Years Warranty

LED COB TRACK LIGHT

For 4 Line Track System

Input Voltage	220-240V 50/60Hz
Beam Angle	24°
CRI	Ra>80
IP Rating	IP20
Dimmable	No

SKU	Watt	Lumen	Body Color	Color	Dimension
5321	25W	2750lm	White	5000K	100.5x85.5x33mm
5322	25W	2750lm	White	4000K	140.5x104.5x33mm
5323	25W	2750lm	White	3000K	180x139x37.5mm
5324	30W	3850lm	White	5000K	140.5x104.5x33mm
5325	30W	3850lm	White	4000K	180x139x37.5mm
5326	30W	3850lm	White	3000K	140.5x104.5x33mm
5327	25W	2750lm	Black	5000K	100.5x85.5x33mm
5328	25W	2750lm	Black	4000K	140.5x104.5x33mm
5329	25W	2750lm	Black	3000K	180x139x37.5mm
5330	30W	3850lm	Black	5000K	140.5x104.5x33mm
5331	30W	3850lm	Black	4000K	180x139x37.5mm
5332	30W	3850lm	Black	3000K	140.5x104.5x33mm

NEW



	White	Black
SKU	15106	15105
Color	CCT	CCT

bridgelux

CRI 90+ 3 Years Warranty

LED COB TRACK LIGHT CCT

For 4 Line Track System

Power	20-25-30W adjustable	Beam Angle	24°-90°
Input Voltage	AC220-240V 50Hz	CRI	Ra>90
Lumens	2700lm	IP Rating	IP20
Size	ø70x210x170mm	Dimmable	No



5 Years Warranty

LED WALL WASHER FOR TRACKS

For 4 Line Track System

Input Voltage	200-240V 50/60Hz
Beam Angle	24°
CRI	Ra>80
IP Rating	IP20
Dimmable	No

SKU	Watt	Lumen	Lumen/W	Color	Dimension
5389	30W	2700lm	80m/W	4000K	605x93x42mm
5390	40W	3600lm	80lm/W	4000K	905x93x42mm



	For 2 Line Tracks		For 4 Line Tracks	
SKU	2019	2020	2017	2018
Color	White	Black	White	Black

LED TRACK LIGHT GU10 -Socket

For 2/4 Line Track System

Socket	1xGU10	Material	Alu
Input Voltage	AC220-240V 50Hz	Max Power	10W / 35W
Size 2 line	ø55x82mm	IP Rating	IP20
Size 4 line	ø59x94mm		



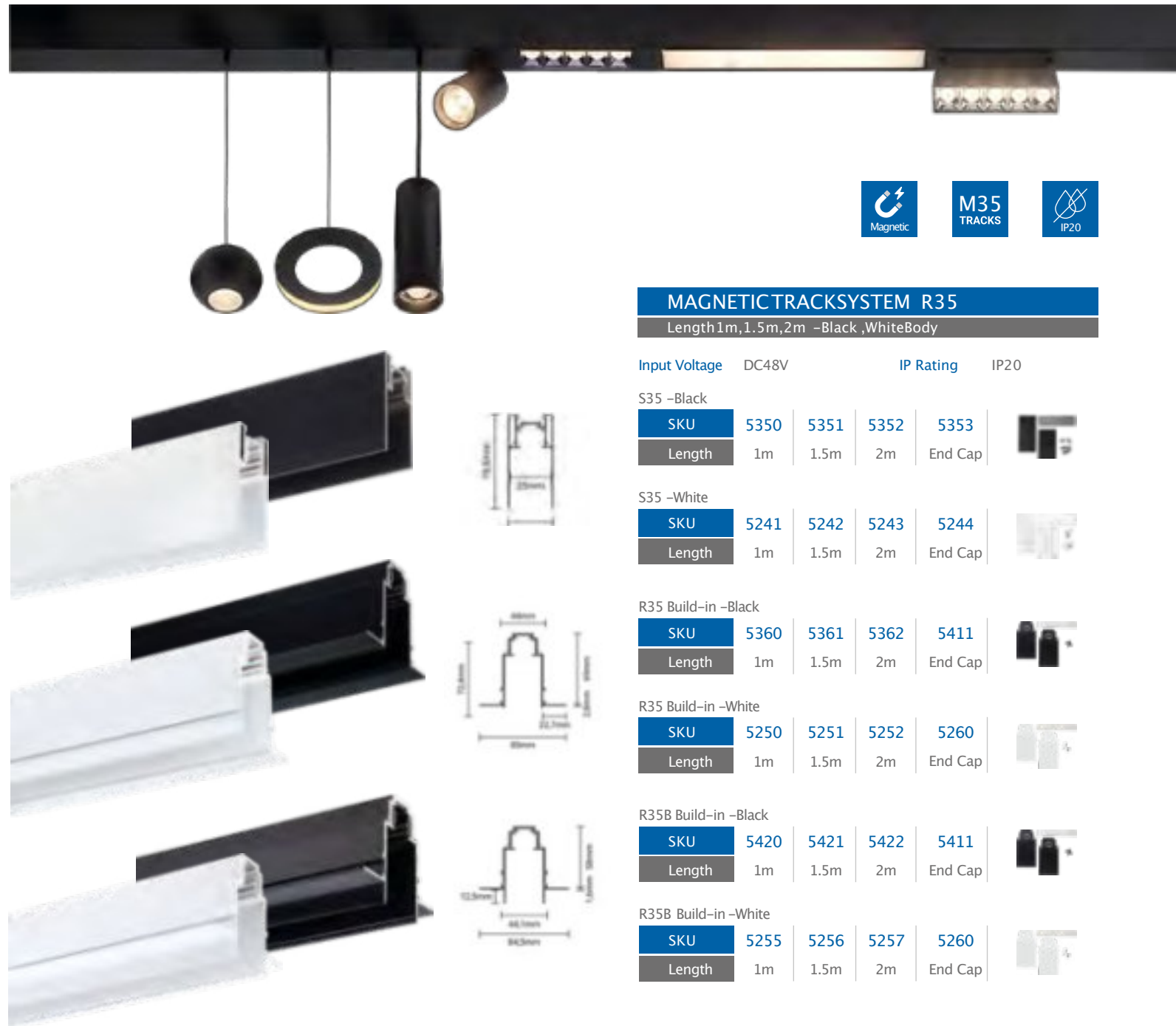

MAGNETIC TRACK SYSTEM R35
Length 1m, 1.5m, 2m -Black ,WhiteBody

Input Voltage DC48V IP Rating IP20

S35 -Black				
SKU	5350	5351	5352	5353
Length	1m	1.5m	2m	End Cap
S35 -White				
SKU	5241	5242	5243	5244
Length	1m	1.5m	2m	End Cap
R35 Build-in -Black				
SKU	5360	5361	5362	5411
Length	1m	1.5m	2m	End Cap
R35 Build-in -White				
SKU	5250	5251	5252	5260
Length	1m	1.5m	2m	End Cap
R35B Build-in -Black				
SKU	5420	5421	5422	5411
Length	1m	1.5m	2m	End Cap
R35B Build-in -White				
SKU	5255	5256	5257	5260
Length	1m	1.5m	2m	End Cap

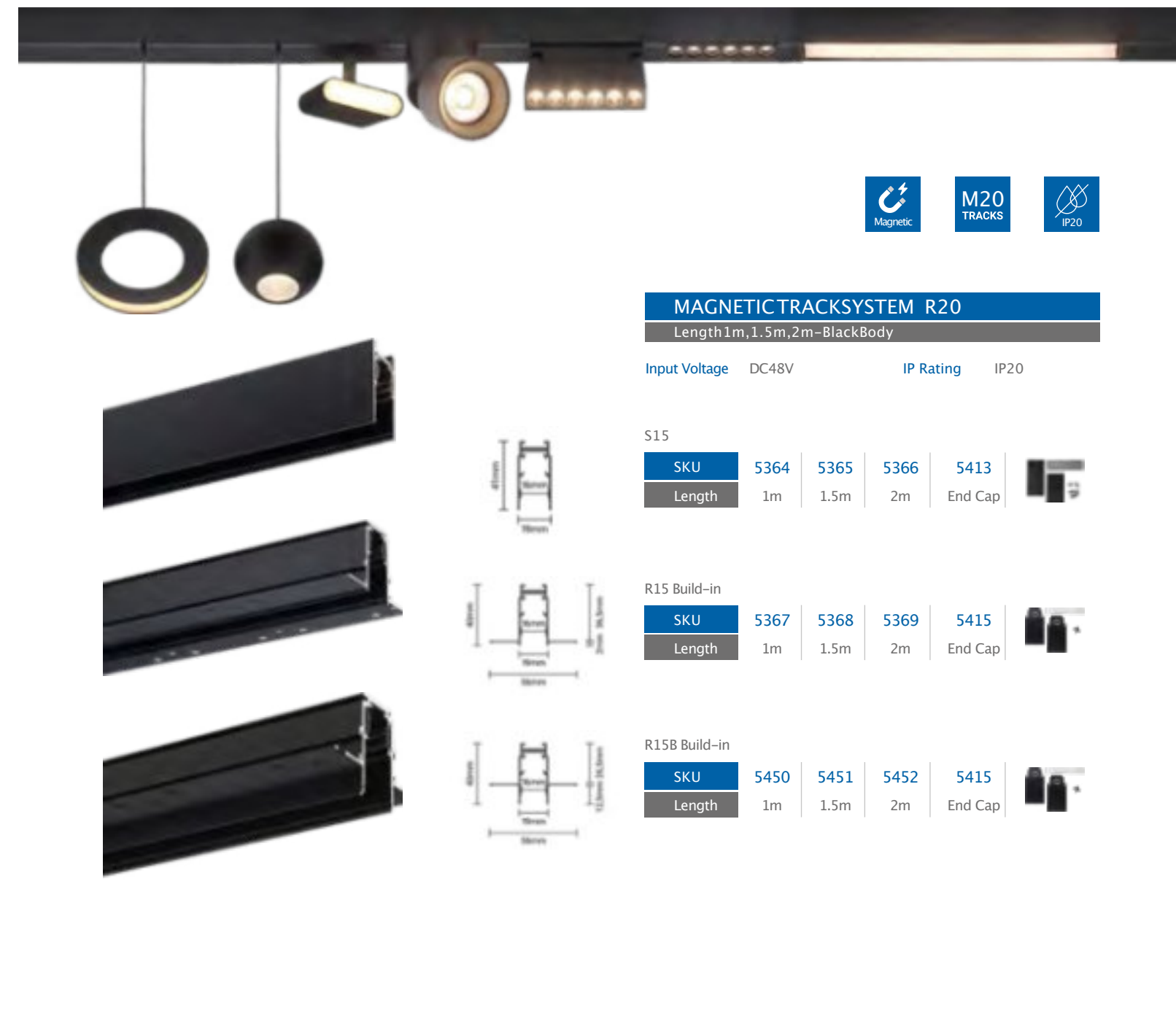

MAGNETIC TRACK SYSTEM R20
Length 1m, 1.5m, 2m -BlackBody

Input Voltage DC48V IP Rating IP20

S15				
SKU	5364	5365	5366	5413
Length	1m	1.5m	2m	End Cap
R15 Build-in				
SKU	5367	5368	5369	5415
Length	1m	1.5m	2m	End Cap
R15B Build-in				
SKU	5450	5451	5452	5415
Length	1m	1.5m	2m	End Cap

SURFACE CORNERS35

SKU	5358	5249
Color	Black	White

SURFACE CORNER R35

SKU	5363	5253
Length	Black	White

CONCAVE ANGLE R35

SKU	5408	5259
Length	Black	White

SURFACE CORNER R35B

SKU	5423	5258
Length	Black	White



SURFACE CORNERS20

SKU	5412
Color	Black

SURFACE CORNER R20

SKU	5414
Length	Black

CONCAVE ANGLE R20

SKU	5409
Length	Black

SURFACE CORNER R20B

SKU	5453
Length	Black



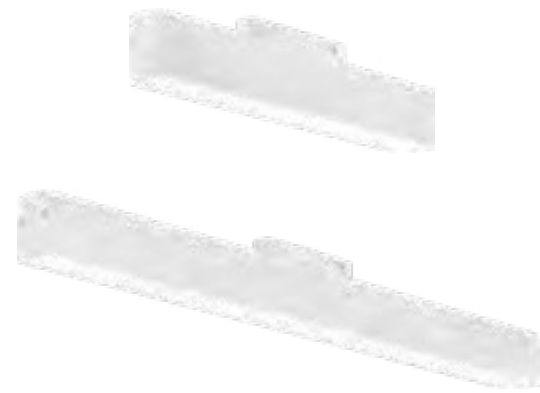

LED MAGNETIC FLOODLIGHT
For M35 Tracks -White

Input Voltage	DC48V
Beam Angle	120°
CRI	Ra>80
IP Rating	IP20

SKU	Watt	Lumen	Dimmable	Color	Dimension
5265	12W	960lm	No	4000K	305x35x67mm
5261	12W	960lm	No	3000K	305x35x67mm
5266	20W	1600lm	No	4000K	605x35x67mm
5262	20W	1600lm	No	3000K	605x35x67mm
5284	12W	960lm	Dimmable 0-10V	4000K	307x35x69mm
5283	12W	960lm	Dimmable 0-10V	3000K	307x35x69mm
5286	20W	1600lm	Dimmable 0-10V	4000K	606x35x69mm
5285	20W	1600lm	Dimmable 0-10V	3000K	606x35x69mm



LED MAGNETIC FLOODLIGHT
For M35 Tracks -Black

Input Voltage	DC48V
Beam Angle	120°
CRI	Ra>80
IP Rating	IP20

SKU	Watt	Lumen	Dimmable	Color	Dimension
5391	12W	960lm	No	4000K	305x35x67mm
5340	12W	960lm	No	3000K	305x35x67mm
5392	20W	1600lm	No	4000K	605x35x67mm
5341	20W	1600lm	No	3000K	605x35x67mm
5275	12W	960lm	Dimmable 0-10V	4000K	307x35x69mm
5274	12W	960lm	Dimmable 0-10V	3000K	307x35x69mm
5278	20W	1600lm	Dimmable 0-10V	4000K	606x35x69mm
5276	20W	1600lm	Dimmable 0-10V	3000K	606x35x69mm



LED MAGNETIC TRACK HEADS
For M35 Tracks

Input Voltage	DC48V
Beam Angle	120°
CRI	Ra>90
IP Rating	IP20



LED MAGNETIC TRACK HEADS
For M35 Tracks -Adjustable

Input Voltage	DC48V
Beam Angle	24°
CRI	Ra>90
IP Rating	IP20

	SKU	Watt	Lumen	Dimmable	Color	Dimension
White	5268	10W	800lm	No	4000K	137x34x68mm
	5267	10W	800lm	No	3000K	137x34x68mm
	5270	20W	1600lm	No	4000K	270x34x67mm
	5269	20W	1600lm	No	3000K	270x34x67mm
	5288	20W	800lm	Dimmable 0-10V	4000K	270x34x67mm
	5287	20W	800lm	Dimmable 0-10V	3000K	270x34x67mm
Black	5393	10W	1600lm	No	4000K	137x34x68mm
	5342	10W	1600lm	No	3000K	137x34x68mm
	5394	20W	800lm	No	4000K	270x34x67mm
	5343	20W	800lm	No	3000K	270x34x67mm
	5280	20W	1600lm	Dimmable 0-10V	4000K	270x34x67mm
	5279	20W	1600lm	Dimmable 0-10V	3000K	270x34x67mm

	SKU	Watt	Lumen	Dimmable	Color	Dimension
White	5273	10W	800lm	No	3000K	137x34x68mm
Black	5398	10W	800lm	No	4000K	137x34x68mm
	5147	10W	800lm	No	3000K	270x34x67mm
	5399	20W	1600lm	No	4000K	270x34x67mm
	5348	20W	1600lm	No	3000K	270x34x67mm





LED MAGNETIC TRACK LIGHT

For M35 Tracks -White

Input Voltage	DC48V
Beam Angle	15°
CRI	Ra>80
IP Rating	IP20

SKU	Watt	Lumen	Dimmable	Color	Dimension
5271	12W	960lm	No	4000K	ø60x140x220mm
5263	12W	960lm	No	3000K	ø60x140x220mm
5290	12W	960lm	Dimmable 0-10V	4000K	ø65x140x220mm
5289	12W	960lm	Dimmable 0-10V	3000K	ø65x140x220mm
5272	20W	1600lm	No	4000K	ø70x140x220mm
5264	20W	1600lm	No	3000K	ø70x140x220mm



LED MAGNETIC TRACK LIGHT

For M35 Tracks -Black

Input Voltage	DC48V
Beam Angle	15°
CRI	Ra>80
IP Rating	IP20

SKU	Watt	Lumen	Dimmable	Color	Dimension
5395	7W	560lm	No	4000K	ø50x140x220mm
5344	7W	560lm	No	3000K	ø50x140x220mm
5396	12W	960lm	No	4000K	ø60x145x175mm
5345	12W	960lm	No	3000K	ø60x145x175mm
5282	12W	960lm	Dimmable 0-10V	4000K	ø65x150x215mm
5281	12W	960lm	Dimmable 0-10V	3000K	ø65x150x215mm
5397	20W	1600lm	No	4000K	ø70x140x190mm
5346	20W	1600lm	No	3000K	ø70x140x190mm



LED MAGNETIC TRACK LIGHT			
For M20/M35 Tracks			
Power	5W	Beam Angle	15-60°
Input Voltage	DC48V	CRI	Ra>90
Lumens	560lm	IP Rating	IP20
Size	ø50x200mm	Dimmable	No
SKU	5319	5320	
Color	4000K	3000K	



LED MAGNETIC SPOTLIGHT			
For M20/M35 Tracks -Adjustable Beam Angle			
Power	7W	Beam Angle	15°-60°
Input Voltage	DC48V	CRI	Ra>90
Lumens	560lm	IP Rating	IP20
Size	ø60x985mm	Dimmable	No
SKU	5400	5349	
Color	4000K	3000K	



LED MAGNETIC TRACK LIGHT			
For M20/M35 Tracks			
Power	6W	Beam Angle	90°
Input Voltage	DC48V	CRI	Ra>90
Lumens	480lm	IP Rating	IP20
Size	ø130x920mm	Dimmable	No
SKU	5335	5334	
Color	4000K	3000K	



LED MAGNETIC TRACK LIGHT			
For M20/M35 Tracks			
Power	10W	Beam Angle	90°
Input Voltage	DC48V	CRI	Ra>90
Lumens	800lm	IP Rating	IP20
Size	ø85x920mm	Dimmable	No
SKU	5337	5336	
Color	4000K	3000K	



LED MAGNETIC TRACK LIGHT			
For M20 Tracks			
Power	10W	Beam Angle	15°
Input Voltage	DC48V	CRI	Ra>90
Lumens	800lm	IP Rating	IP20
Size	ø72x105x141mm	Dimmable	No
SKU	5378	5379	
Color	4000K	3000K	



LED MAGNETIC FLOODLIGHT			
For M20 Tracks			
Power	12W	Beam Angle	15°
Input Voltage	DC48V	CRI	Ra>90
Lumens	960lm	IP Rating	IP20
Size	ø60x105x170mm	Dimmable	No
SKU	5315	5316	
Color	4000K	3000K	



LED MAGNETIC FLOODLIGHT			
For M20/M35 Tracks			
Power	5W	Beam Angle	50°
Input Voltage	DC48V	CRI	Ra>90
Lumens	400lm	IP Rating	IP20
Size	88x75mm	Dimmable	No
SKU	5339	5338	
Color	4000K	3000K	



LED MAGNETIC FLOODLIGHT			
For M20 Tracks			
Material	Aluminium	CRI	Ra>80
Input Voltage	DC48V	IP Rating	IP20
Beam Angle	120°	Dimmable	No
SKU	Watt	Lumen	Lumen/W
5416	10W	800lm	80lm/W
5417	10W	800lm	80lm/W
5418	18W	1440lm	80lm/W
5419	18W	1440lm	80lm/W



LED MAGNETIC TRACK LIGHT HEADS			
For M20 Tracks			
Material	Aluminium	CRI	Ra>90
Input Voltage	DC48V	IP Rating	IP20
Beam Angle	24°	Dimmable	No
SKU	Watt	Lumen	Lumen/W
5311	6W	480lm	80lm/W
5312	6W	480lm	80lm/W
5313	12W	960lm	80lm/W
5314	12W	960lm	80lm/W



LED MAGNETIC TRACK LIGHT HEADS			
For M20 Tracks -Adjustable			
Material	Aluminium	CRI	Ra>90
Input Voltage	DC48V	IP Rating	IP20
Beam Angle	24°	Dimmable	No
SKU	Watt	Lumen	Lumen/W
5317	9W	720lm	80lm/W
5318	9W	720lm	80lm/W



MAGNETIC TRACK SYSTEM R15
Length 1m, 1.5m, 2m - Black Body



Input Voltage	DC48V	IP Rating	IP20
S15			
SKU	5207	5208	5209
Length	1m	1.5m	2m
R15 Build-in			
SKU	5204	5205	5206
Length	1m	1.5m	2m
R15B Build-in			
SKU	5201	5202	5203
Length	1m	1.5m	2m



SLIM POWERSUPPLIES
For M15 Tracks -48V

Input Voltage	220V 50/60Hz
Material	Aluminium
IP Rating	IP20
Dimmable	No



SKU	Watt	Output Voltage	Current	Dimension
5214	80W	DC: 48V	1.66A	262x15.7x34mm
5215	150W	DC: 48V	3.12A	262x15.7x34mm



LED MAGNETIC FLOODLIGHT
For M15 Tracks

Material	Aluminium	CRI	Ra>90
Input Voltage	DC48V	IP Rating	IP20
Beam Angle	120°	Dimmable	No

SKU	Watt	Lumen	Lumen/W	Color	Dimension
5225	10W	650lm	65lm/W	4000K	305x15x32mm
5226	10W	650lm	65lm/W	3000K	305x15x32mm
5227	20W	1300lm	65lm/W	4000K	606x15x32mm
5228	20W	1300lm	65lm/W	3000K	606x15x32mm



LED MAGNETIC TRACK LIGHT HEADS
For M15 Tracks

Material	Aluminium	CRI	Ra>90
Input Voltage	DC48V	IP Rating	IP20
Beam Angle	24°	Dimmable	No

SKU	Watt	Lumen	Lumen/W	Color	Dimension
5229	12W	780lm	80lm/W	4000K	235x15x32mm
5230	12W	780lm	80lm/W	3000K	235x15x32mm



LED MAGNETIC FLOODLIGHT
For M15 Tracks

Material	Aluminium	CRI	Ra>90
Input Voltage	DC48V	IP Rating	IP20
Beam Angle	24°	Dimmable	No

SKU	Watt	Lumen	Lumen/W	Color	Dimension
5221	6W	480lm	80lm/W	4000K	ø35x129x116mm
5222	6W	480lm	80lm/W	3000K	ø35x129x116mm
5223	10W	800lm	80lm/W	4000K	ø44x129x135mm
5224	10W	800lm	80lm/W	3000K	ø44x129x135mm



MINI MAGNETIC TRACK SYSTEM
Length 1m, 1.5m, 2m - Black Body

Input Voltage DC48V IP Rating IP20

SKU	5480	5481	5482
Length	1m	1.5m	2m



- SKU 5483 Straight Connector
- SKU 5484 L-Connector
- SKU 5485 T-Connector
- SKU 5486 Cross Connector
- SKU 5487 90 Degree Connector

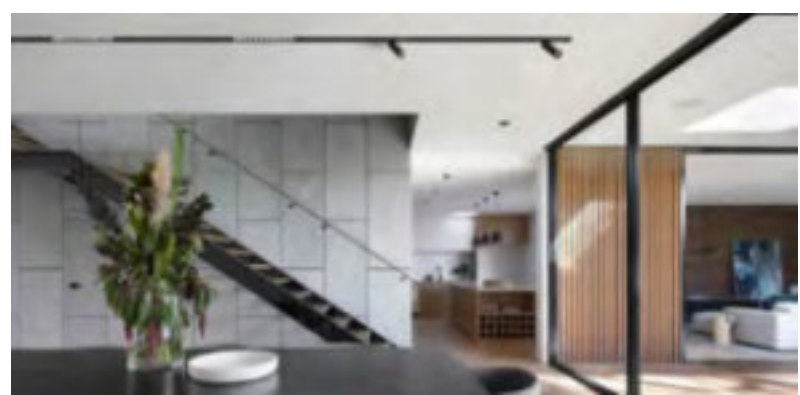

MINI POWER SUPPLIES
Aluminium -48V

Input Voltage	220V 50/60Hz
Material	Aluminium
IP Rating	IP20
Dimmable	No

SKU	Watt	Output Voltage	Current	Dimension
5488	100W	DC: 48V	2.08A	33x30x370mm
5489	200W	DC: 48V	4.16A	33x30x470mm

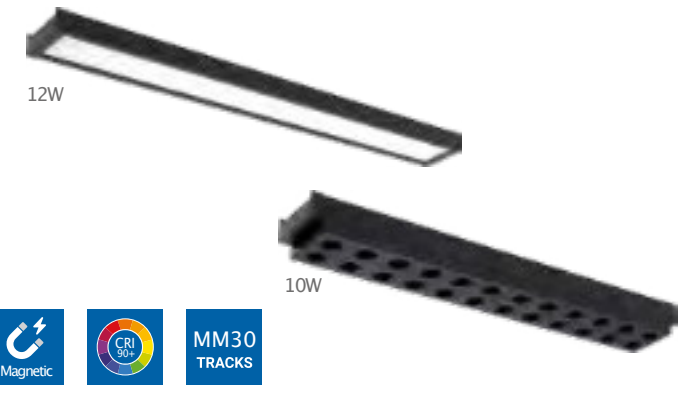

LED MINI TRACK LIGHT
For Mini MM30 Tracks

Power	12W ; 10W	Beam Angle	120° ; 25°
Input Voltage	DC48V	CRI	Ra>90
Lumens	400lm ; 520lm	IP Rating	IP20
Size 12W	300x32x11mm	Dimmable	No
Size 10W	240x32x11mm		

	12W		10W	
SKU	5490	5491	5492	5493
Color	4000K	3000K	4000K	3000K

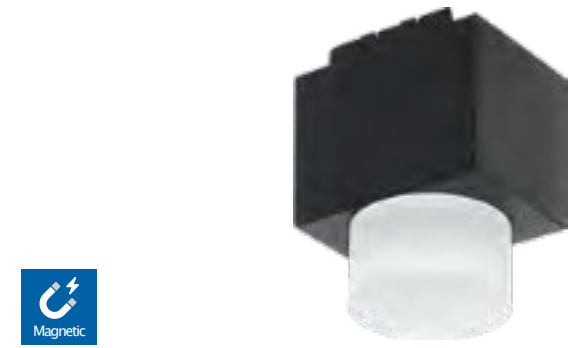

LED MINI TRACK LIGHT
For Mini MM30 Tracks

Power	4W	Beam Angle	80°
Input Voltage	DC48V	CRI	Ra>90
Lumens	240lm	IP Rating	IP20
Size	48x35x60mm	Dimmable	No

SKU	5498	5499
Color	4000K	3000K



LED MINI TRACK LIGHT
For Mini MM30 Tracks

Power	5W	Beam Angle	38°
Input Voltage	DC48V	CRI	Ra>90
Lumens	425lm	IP Rating	IP20
Size	48x35x60mm	Dimmable	No

SKU	5496	5497
Color	4000K	3000K



LED MINI TRACK LIGHT
For Mini MM30 Tracks

Power	6W	Beam Angle	32°
Input Voltage	DC48V	CRI	Ra>90
Lumens	720lm	IP Rating	IP20
Size	ø54x63x98mm	Dimmable	No

SKU	5494	5495
Color	4000K	3000K



M35 TRACKS



SLIM POWERSUPPLIES
For M35 Tracks -White -48V

Input Voltage	220V 50/60Hz	IP Rating	IP20
Material	Aluminium	Dimmable	No

SKU	Watt	OutputVoltage	Current	Dimension
5216	100W	DC: 48V	2.1A	238x32.6x42.7mm
5217	200W	DC: 48V	4.16A	307x32.4x45mm

M35 TRACKS



SLIM POWERSUPPLIES
For M35 Tracks -Black -48V

Input Voltage	220V 50/60Hz	IP Rating	IP20
Material	Aluminium	Dimmable	No

SKU	Watt	OutputVoltage	Current	Dimension
5426	100W	DC: 48V	2.1A	238x32x42mm
5427	200W	DC: 48V	4.2A	307x32.0x4.3mm
5428	280W	DC: 48V	5.85A	307x32.0x4.3mm

M20 TRACKS



SLIM POWERSUPPLIES
For M20 Tracks -Black -48V

Input Voltage	220V 50/60Hz	IP Rating	IP20
Material	Aluminium	Dimmable	No

SKU	Watt	OutputVoltage	Current	Dimension
5424	100W	DC: 48V	2.08A	33x30x370mm
5425	200W	DC: 48V	4.16A	33x30x470mm

M35 TRACKS



POWERSUPPLIES
For M35 Tracks -Metal -48V

Input Voltage	220V 50/60Hz	IP Rating	IP20
Material	Aluminium	Dimmable	No

SKU	Watt	OutputVoltage	Current	Dimension
6284	120W	DC: 48V	2.5A	160x98x30mm
6285	250W	DC: 48V	5.2A	215x115x30mm

SKU 5247
StraightJoint M20/M35



SKU 5248
FlexibleJoint M20/M35

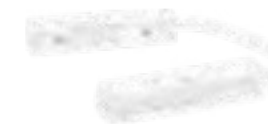

SKU 5246
Input Cable M20/M35



SKU 5245
HangingAccessories M20/M35



SKU 5356
StraightJoint M20/M35



SKU 5357
FlexibleJoint M20/M35



SKU 5355
Input Cable M20/M35



SKU 5354
HangingAccessories M20/M35



SKU 5212
StraightJoint M15



SKU 5213
FlexibleJoint M15



SKU 5211
Input Cable M15



SKU 5210
HangingAccessories M15



SKU 5254
Cover Plate M35 -3m -White



SKU 5370
Cover Plate M35 -3m -Black



SKU 5359
Cover Plate M20 -3m

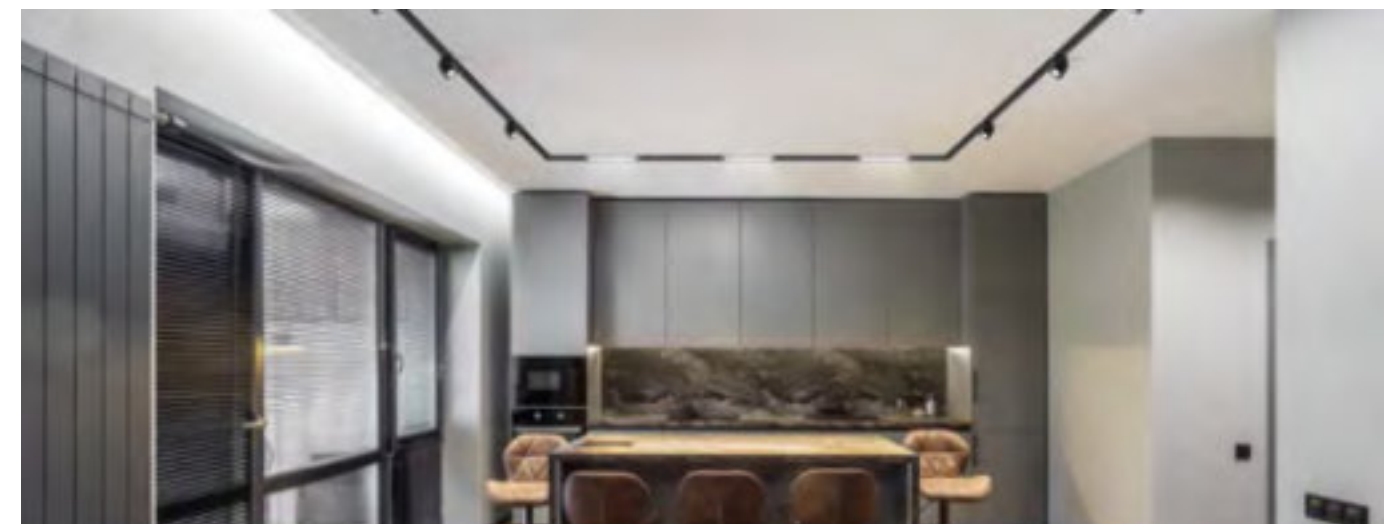



LED Floodlights

LED floodlights are the go-to solution for powerful outdoor illumination, ideal for lighting up large areas with efficiency and reliability. From private villas and gardens to warehouses and industrial yards, they deliver consistent brightness while reducing energy consumption. Built to withstand tough conditions, they are a durable choice for any outdoor project.

Features:

- Up to 80% energy savings compared to traditional floodlights
- High lumen output with wide beam angles for broad coverage
- IP65-rated for reliable outdoor performance
- Wall, ground, or pylon mounting options
- Sturdy construction for long-lasting durability
- Optional models with integrated solar panels

Applications:

- Outdoor lighting for gardens, courtyards, and driveways
- Large area coverage for warehouses, yards, and parking lots
- Residential, commercial, and industrial projects

NEW



LED SMD FLOODLIGHT
PREMIUM LINE
White Body

Input Voltage	180-265V 50/60Hz
Beam Angle	90°
CRI	Ra>80
IP Rating	IP65
Dimmable	No

SKU	Watt	Lumen	Lumen/W	Color	Dimension
15859	10W	1000lm	100lm/W	6000K	122x89x19.5mm
15860	10W	1000lm	100lm/W	4000K	122x89x19.5mm
15861	10W	1000lm	100lm/W	3000K	122x89x19.5mm
15862	20W	2000lm	100lm/W	6000K	139.6x97.6x23.7mm
15863	20W	2000lm	100lm/W	4000K	139.6x97.6x23.7mm
15864	20W	2000lm	100lm/W	3000K	139.6x97.6x23.7mm
15865	30W	3000lm	100lm/W	6000K	169x140x29mm
15866	30W	3000lm	100lm/W	4000K	169x140x29mm
15867	30W	3000lm	100lm/W	3000K	169x140x29mm
15868	50W	5000lm	100lm/W	6000K	202x167x31mm
15869	50W	5000lm	100lm/W	4000K	202x167x31mm
15870	50W	5000lm	100lm/W	3000K	202x167x31mm
15871	100W	10000lm	100lm/W	6000K	260x225x34mm
15872	100W	10000lm	100lm/W	4000K	260x225x34mm
15873	100W	10000lm	100lm/W	3000K	260x225x34mm

NEW



LED SMD FLOODLIGHT
PREMIUM LINE
High Power -Black Body

Input Voltage	180-265V 50/60Hz
Beam Angle	90°
CRI	Ra>80
IP Rating	IP65
Dimmable	No

SKU	Watt	Lumen	Lumen/W	Color	Dimension
15889	150W	15000lm	100lm/W	6000K	300x256x38mm
15890	150W	15000lm	100lm/W	4000K	300x256x38mm
15891	200W	28000lm	140lm/W	6000K	345x291x38mm
15892	200W	28000lm	140lm/W	4000K	345x291x38mm
15893	300W	42000lm	140lm/W	6000K	400x331x49mm
15894	300W	42000lm	140lm/W	4000K	400x331x49mm
15895	400W	56000lm	140lm/W	6000K	535x455x60mm
15896	400W	56000lm	140lm/W	4000K	535x455x60mm
15897	500W	70000lm	140lm/W	6000K	535x455x60mm
15898	500W	70000lm	140lm/W	4000K	535x455x60mm

NEW



LED SMD FLOODLIGHT
PREMIUM LINE
Black Body

Input Voltage	180-265V 50/60Hz
Beam Angle	90°
CRI	Ra>80
IP Rating	IP65
Dimmable	No

SKU	Watt	Lumen	Lumen/W	Color	Dimension
15874	10W	1000lm	100lm/W	6000K	122x89x19.5mm
15875	10W	1000lm	100lm/W	4000K	122x89x19.5mm
15876	10W	1000lm	100lm/W	3000K	122x89x19.5mm
15877	20W	2000lm	100lm/W	6000K	139.6x97.6x23.7mm
15878	20W	2000lm	100lm/W	4000K	139.6x97.6x23.7mm
15879	20W	2000lm	100lm/W	3000K	139.6x97.6x23.7mm
15880	30W	3000lm	100lm/W	6000K	169x140x29mm
15881	30W	3000lm	100lm/W	4000K	169x140x29mm
15882	30W	3000lm	100lm/W	3000K	169x140x29mm
15883	50W	5000lm	100lm/W	6000K	202x167x31mm
15884	50W	5000lm	100lm/W	4000K	202x167x31mm
15885	50W	5000lm	100lm/W	3000K	202x167x31mm
15886	100W	10000lm	100lm/W	6000K	260x225x34mm
15887	100W	10000lm	100lm/W	4000K	260x225x34mm
15888	100W	10000lm	100lm/W	3000K	260x225x34mm

NEW



LED SMD FLOODLIGHT
Milky Reflector

Input Voltage	180-265V 50/60Hz
Beam Angle	120°
CRI	Ra>80
IP Rating	IP65
Dimmable	No

SKU	Watt	Lumen	Lumen/W	Color	Dimension
5991	20W	1600lm	80lm/W	4000K	100.5x85.5x33mm
5992	30W	2400lm	80lm/W	4000K	140.5x104.5x33mm
5993	50W	4000lm	80lm/W	4000K	180x139x37.5mm



NEW



LED SMD FLOODLIGHT
White Body

Input Voltage	180-265V 50/60Hz
Beam Angle	120°
CRI	Ra>80
IP Rating	IP65
Dimmable	No

SKU	Watt	Lumen	Lumen/W	Color	Dimension
15801	10W	900lm	90lm/W	6000K	101.5x98x26mm
15802	10W	900lm	90lm/W	4000K	101.5x98x26mm
15803	10W	900lm	90lm/W	3000K	101.5x98x26mm
15804	20W	1800lm	90lm/W	6000K	120x112.5x27.5mm
15805	20W	1800lm	90lm/W	4000K	120x112.5x27.5mm
15806	20W	1800lm	90lm/W	3000K	120x112.5x27.5mm
15807	30W	2700lm	90lm/W	6000K	156x141x30mm
15808	30W	2700lm	90lm/W	4000K	156x141x30mm
15809	30W	2700lm	90lm/W	3000K	156x141x30mm
15810	50W	4500lm	90lm/W	6000K	188x170x32mm
15811	50W	4500lm	90lm/W	4000K	188x170x32mm
15812	50W	4500lm	90lm/W	3000K	188x170x32mm
15813	100W	9000lm	90lm/W	6000K	242x212x33.5mm
15814	100W	9000lm	90lm/W	4000K	242x212x33.5mm
15815	100W	9000lm	90lm/W	3000K	242x212x33.5mm

NEW



LED SMD FLOODLIGHT
With PIR Sensor -White Body

Input Voltage	180-265V 50/60Hz
Beam Angle	120°
CRI	Ra>80
IP Rating	IP65
Dimmable	No

SKU	Watt	Lumen	Lumen/W	Color	Dimension
15837	10W	900lm	90lm/W	6000K	97x169x54mm
15838	10W	900lm	90lm/W	4500K	97x169x54mm
15839	10W	900lm	90lm/W	2700K	97x169x54mm
15840	20W	1800lm	90lm/W	6000K	121x190x54mm
15841	20W	1800lm	90lm/W	4500K	121x190x54mm
15842	20W	1800lm	90lm/W	2700K	121x190x54mm
15843	30W	2700lm	90lm/W	6000K	154x228x55mm
15844	30W	2700lm	90lm/W	4500K	154x228x55mm
15845	30W	2700lm	90lm/W	2700K	154x228x55mm
15846	50W	4500lm	90lm/W	6000K	183x205x31.7mm
15847	50W	4500lm	90lm/W	4500K	183x205x31.7mm

NEW



LED SMD FLOODLIGHT
Black Body

Input Voltage	180-265V 50/60Hz
Beam Angle	120°
CRI	Ra>80
IP Rating	IP65
Dimmable	No

SKU	Watt	Lumen	Lumen/W	Color	Dimension
15816	10W	900lm	90lm/W	6000K	101.5x98x26mm
15817	10W	900lm	90lm/W	4000K	101.5x98x26mm
15818	10W	900lm	90lm/W	3000K	101.5x98x26mm
15819	20W	1800lm	90lm/W	6000K	120x112.5x27.5mm
15820	20W	1800lm	90lm/W	4000K	120x112.5x27.5mm
15821	20W	1800lm	90lm/W	3000K	120x112.5x27.5mm
15822	30W	2700lm	90lm/W	6000K	156x141x30mm
15823	30W	2700lm	90lm/W	4000K	156x141x30mm
15824	30W	2700lm	90lm/W	3000K	156x141x30mm
15825	50W	4500lm	90lm/W	6000K	188x170x32mm
15826	50W	4500lm	90lm/W	4000K	188x170x32mm
15827	50W	4500lm	90lm/W	3000K	188x170x32mm
15828	100W	9000lm	90lm/W	6000K	242x212x33.5mm
15829	100W	9000lm	90lm/W	4000K	242x212x33.5mm
15830	100W	9000lm	90lm/W	3000K	242x212x33.5mm
15831	150W	13500lm	90lm/W	6000K	279.5x230x35.5mm
15832	150W	13500lm	90lm/W	4000K	279.5x230x35.5mm
15833	200W	18000lm	90lm/W	6000K	329x275x37.5mm
15834	200W	18000lm	90lm/W	4000K	329x275x37.5mm
15835	300W	27000lm	90lm/W	6000K	379x312.5x45mm
15836	300W	27000lm	90lm/W	4000K	379x312.5x45mm

NEW

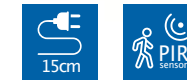

LED SMD FLOODLIGHT
With PIR Sensor -Black Body

Input Voltage	180-265V 50/60Hz
Beam Angle	120°
CRI	Ra>80
IP Rating	IP65
Dimmable	No

SKU	Watt	Lumen	Lumen/W	Color	Dimension
15848	10W	900lm	90lm/W	6000K	97x169x54mm
15849	10W	900lm	90lm/W	4500K	97x169x54mm
15850	10W	900lm	90lm/W	2700K	97x169x54mm
15851	20W	1800lm	90lm/W	6000K	121x190x54mm
15852	20W	1800lm	90lm/W	4500K	121x190x54mm
15853	20W	1800lm	90lm/W	2700K	121x190x54mm
15854	30W	2700lm	90lm/W	6000K	154x228x55mm
15855	30W	2700lm	90lm/W	4500K	154x228x55mm
15856	30W	2700lm	90lm/W	2700K	154x228x55mm
15857	50W	4500lm	90lm/W	6000K	183x205x31.7mm
15858	50W	4500lm	90lm/W	4500K	183x205x31.7mm



LED SMD FLOODLIGHT

White Body

Input Voltage	220-240V 50/60Hz
Beam Angle	90°
CRI	Ra>80
IP Rating	IP65
Dimmable	No

SKU	Watt	Lumen	Lumen/W	Color	Dimension
5701	10W	900lm	90lm/W	6000K	97.5x111x22mm
5702	10W	900lm	90lm/W	4500K	97.5x111x22mm
5703	10W	900lm	90lm/W	2700K	97.5x111x22mm
5704	20W	1800lm	90lm/W	6000K	121x130x23mm
5705	20W	1800lm	90lm/W	4500K	121x130x23mm
5706	20W	1800lm	90lm/W	2700K	121x130x23mm
5707	30W	2700lm	90lm/W	6000K	155x169.5x31mm
5708	30W	2700lm	90lm/W	4500K	155x169.5x31mm
5709	30W	2700lm	90lm/W	2700K	155x169.5x31mm
5710	50W	4500lm	90lm/W	6000K	183x205x31.7mm
5711	50W	4500lm	90lm/W	4500K	183x205x31.7mm
5712	50W	4500lm	90lm/W	2700K	183x205x31.7mm
5713	100W	9000lm	90lm/W	6000K	216.5x244x33mm
5714	100W	9000lm	90lm/W	4500K	216.5x244x33mm
5715	100W	9000lm	90lm/W	2700K	216.5x244x33mm



LED SMD FLOODLIGHT

With PIR Sensor -White Body

Input Voltage	220-240V 50/60Hz
Beam Angle	90°
CRI	Ra>80
IP Rating	IP65
Dimmable	No

SKU	Watt	Lumen	Lumen/W	Color	Dimension
5760	10W	900lm	90lm/W	6000K	97x169x54mm
5761	10W	900lm	90lm/W	4500K	97x169x54mm
5762	10W	900lm	90lm/W	2700K	97x169x54mm
5763	20W	1800lm	90lm/W	6000K	121x190x54mm
5764	20W	1800lm	90lm/W	4500K	121x190x54mm
5765	20W	1800lm	90lm/W	2700K	121x190x54mm
5766	30W	2700lm	90lm/W	6000K	154x228x55mm
5767	30W	2700lm	90lm/W	4500K	154x228x55mm
5768	30W	2700lm	90lm/W	2700K	154x228x55mm
5769	50W	4500lm	90lm/W	6000K	183x205x31.7mm
5770	50W	4500lm	90lm/W	4500K	183x205x31.7mm



LED SMD FLOODLIGHT

Black Body

Input Voltage	220-240V 50/60Hz
Beam Angle	90°
CRI	Ra>80
IP Rating	IP65
Dimmable	No

SKU	Watt	Lumen	Lumen/W	Color	Dimension
5721	10W	900lm	90lm/W	6000K	97.5x111x22mm
5722	10W	900lm	90lm/W	4500K	97.5x111x22mm
5723	10W	900lm	90lm/W	2700K	97.5x111x22mm
5724	20W	1800lm	90lm/W	6000K	121x130x23mm
5725	20W	1800lm	90lm/W	4500K	121x130x23mm
5726	20W	1800lm	90lm/W	2700K	121x130x23mm
5727	30W	2700lm	90lm/W	6000K	155x169.5x31mm
5728	30W	2700lm	90lm/W	4500K	155x169.5x31mm
5729	30W	2700lm	90lm/W	2700K	155x169.5x31mm
5730	50W	4500lm	90lm/W	6000K	183x205x31.7mm
5731	50W	4500lm	90lm/W	4500K	183x205x31.7mm
5732	50W	4500lm	90lm/W	2700K	183x205x31.7mm
5733	100W	9000lm	90lm/W	6000K	216.5x244x33mm
5734	100W	9000lm	90lm/W	4500K	216.5x244x33mm
5735	100W	9000lm	90lm/W	2700K	216.5x244x33mm
5736	150W	13500lm	90lm/W	6000K	250x277x33mm
5737	150W	13500lm	90lm/W	4500K	250x277x33mm
5738	200W	18000lm	90lm/W	6000K	284x318x33mm
5739	200W	18000lm	90lm/W	4500K	284x318x33mm



LED SMD FLOODLIGHT

With PIR Sensor -Black Body

Input Voltage	220-240V 50/60Hz
Beam Angle	90°
CRI	Ra>80
IP Rating	IP65
Dimmable	No

SKU	Watt	Lumen	Lumen/W	Color	Dimension
5771	10W	900lm	90lm/W	6000K	97x169x54mm
5772	10W	900lm	90lm/W	4500K	97x169x54mm
5773	10W	900lm	90lm/W	2700K	97x169x54mm
5774	20W	1800lm	90lm/W	6000K	121x190x54mm
5775	20W	1800lm	90lm/W	4500K	121x190x54mm
5776	20W	1800lm	90lm/W	2700K	121x190x54mm
5777	30W	2700lm	90lm/W	6000K	154x228x55mm
5778	30W	2700lm	90lm/W	4500K	154x228x55mm
5779	30W	2700lm	90lm/W	2700K	154x228x55mm
5780	50W	4500lm	90lm/W	6000K	183x205x31.7mm
5781	50W	4500lm	90lm/W	4500K	183x205x31.7mm

NEW



NOT INCLUDED

SKU	*Optional Sensors
5985	PIR Sensor
5986	PIR With Adjustment
5987	Day /Night Sensor

LED SMD FLOODLIGHT	
CCT Light –Optional Sensors	
Input Voltage	180–265V 50/60Hz
Beam Angle	120°
CRI	Ra>80
IP Rating	IP65
Dimmable	No



SKU	Watt	Lumen	Lumen/W	Color	Dimension
5981	20W	1800lm	90lm/W	CCT	121.7x121.8x26mm
5982	30W	2700lm	90lm/W	CCT	154.7x150x26mm
5983	50W	4500lm	90lm/W	CCT	186.9x187x35.6mm
5984	100W	9000lm	90lm/W	CCT	227.6x235x37.6mm



LED SMD FLOODLIGHT	
On Stand –Foldable –Yellow Body	
Input Voltage	200–240V 50/60Hz
Beam Angle	120°
CRI	Ra>80
IP Rating	IP65
Dimmable	No



SKU	Watt	Lumen	Lumen/W	Color	Dimension
5403	20W	1600lm	80lm/W	6000K	174x249x252mm
5404	30W	2400lm	80lm/W	6000K	214x292x296mm
5405	50W	4000lm	80lm/W	6000K	254x345x337mm



LED SMD FLOODLIGHT	
CCT Light PF>0.9	
Input Voltage	200–277V 50/60Hz
Beam Angle	120°
CRI	Ra>80
IP Rating	IP66
Dimmable	No



SKU	Watt	Lumen	Lumen/W	Color	Dimension
5303	50W	5000lm	100lm/W	CCT	228x230x52 mm
5304	100W	10000lm	100lm/W	CCT	278x300x52 mm
5305	150W	15000lm	100lm/W	CCT	394x325x56 mm
5306	200W	20000lm	100lm/W	CCT	394x376x56 mm



LED SMD FLOODLIGHT	
Portable –Rechargeable +Battery	
Input Voltage	200–240V 50/60Hz
Beam Angle	120°
CRI	Ra>80
IP Rating	IP44
Dimmable	No



SKU	Watt	Lumen	Battery	Color	Dimension
5401	10W	600lm	3.7V 2200mAh	6000K	126x133x218mm
5402	20W	1200lm	3.7V 4400mAh	6000K	156x163x250mm



LED SMD FLOODLIGHT

Green Light –Black Body

Input Voltage	200–240V 50/60Hz
Beam Angle	90°
CRI	Ra>80
IP Rating	IP65
Dimmable	No



SKU	Watt	Lumen	Lumen/W	Color	Dimension
5751	10W	800lm	80lm/W	Green	97.5x111x22mm
5752	20W	1600lm	80lm/W	Green	121x130x23mm
5753	30W	2400lm	80lm/W	Green	155x169.5x31mm

NEW



LED CCT SOLAR FLOODLIGHT

Remote control /Saving battery button

Solar Panel	5V
Beam Angle	120°
CRI	Ra>80
IP Rating	IP65
Dimmable	Yes



SKU	Solar Panel	Lumen	Battery	Color	Dimension
15403	10W	1600lm	3.2V 8Ah	CCT	232x60x175mm
15404	20W	3300lm	3.2V 10Ah	CCT	280x60x215mm
15405	30W	4800lm	3.2V 15Ah	CCT	280x60x215mm



LED RGB SMD FLOODLIGHT

Black Body +Remote Control

Input Voltage	200–240V 50/60Hz
Beam Angle	120°
CRI	Ra>80
IP Rating	IP65
Dimmable	No



SKU	Watt	Lumen	Lumen/W	Color	Dimension
5754	10W	900lm	90lm/W	RGB	97.5x111x22mm
5755	30W	2700lm	90lm/W	RGB	155x169.5x31mm
5756	50W	4500lm	90lm/W	RGB	183x205x31.7mm



LED SOLAR FLOODLIGHT

Remote control

Solar Panel	5V
Beam Angle	120°
CRI	Ra>80
IP Rating	IP65
Dimmable	No



SKU	Solar Panel	Lumen	Battery	Color	Dimension
5460	12W	800lm	3.2V 5.5Ah	6000K	205x170x55mm
5461	16W	1300lm	3.2V 11Ah	6000K	245x210x65mm
5462	20W	1800lm	6.4V 11Ah	6000K	275x235x65mm



LED SOLAR POWER FLOODLIGHT

With Solar Panel and Remote

Solar Panel	5V
Beam Angle	90°
CRI	Ra>80
IP Rating	IP65
Dimmable	No

SKU	EQ.Watt	Lumen	Battery	Color	Dimension
5291	6W	800lm	3.2V 6Ah	6000K	200x210x10mm
5292	10W	1200lm	3.2V 10Ah	6000K	210x340x10mm
5293	15W	2000lm	3.2V 15Ah	6000K	390x230x15mm
5294	20W	2600lm	3.2V 20Ah	6000K	390x300x15mm
5295	25W	3200lm	3.2V 25Ah	6000K	390x360x15mm
5296	30W	3800lm	3.2V 30Ah	6000K	390x430x15mm
5297	40W	4800lm	3.2V 40Ah	6000K	390x560x15mm
HIGH POWER 5298	40W	6000lm	3.2V 40Ah	6000K	298x225x41mm



LED CCT SOLAR FLOODLIGHT

With Solar Panel and Remote

Solar Panel	5V
Beam Angle	120°
CRI	Ra>80
IP Rating	IP65
Dimmable	No

SKU	EQ.Watt	Lumen	Battery	Color	Dimension
5473	10W	1000lm	3.2V 10Ah	CCT	222x160x23.5mm
5474	10W	1800lm	3.2V 20Ah	CCT	288x208x22mm
5475	30W	2700lm	3.2V 30Ah	CCT	354x249x23mm
NOFast Charge 5468	30W	3000lm	3.2V 30Ah	CCT	245x303x52mm



LED SOLAR POWER FLOODLIGHT

With Solar Panel and Remote

Solar Panel	6V
Beam Angle	120°
CRI	Ra>80
IP Rating	IP65
Dimmable	No

SKU	EQ.Watt	Lumen	Battery	Color	Dimension
5430	8W	500lm	3.2V 5Ah	6000K	169x52x206mm
5431	16W	1200lm	3.2V 10Ah	6000K	206x52x253mm
5432	20W	1600lm	3.2V 15Ah	6000K	206x52x253mm
5433	25W	2200lm	3.2V 20Ah	6000K	245x52x303mm



LED SOLAR POWER FLOODLIGHT

With Solar Panel and Remote

Solar Panel	3.2V
Beam Angle	90°
CRI	Ra>80
IP Rating	IP65
Dimmable	No

SKU	EQ.Watt	Lumen	Battery	Color	Dimension
5455	6W	400lm	3.2V 5Ah	6000K	211x43x177mm
5456	8W	500lm	3.2V 6Ah	6000K	211x43x177 mm
5457	15W	1200lm	3.2V 10Ah	6000K	211x43x271mm
5458	20W	1800lm	3.2V 20Ah	6000K	280x80x320mm
5459	30W	2400lm	3.2V 25Ah	6000K	280x80x320mm

LED SMD PORTABLE FLOODLIGHT

Solar Panel Power: 6V /2.3W

Flux	1850lm
Battery	3.7V 8Ah
Body Color	Yellow
Beam Angle	120°
CRI	Ra>80
Dimension	215x175x55mm

- SOS Emergency Light
- Power Bank Function
- USB Ports



SKU CCT
5464



TERMINAL BLOCK

Waterproof Box IP68

Rated Voltage	250V	Wire Range	0.5-1.5mm ²
Rated Current	16A	Wire Range T	0.5-3.5mm ²



SKU Straight T-Shape
6641 6642



TERMINAL BLOCK Professional

Polycarbonate -Waterproof Box IP68

Rated Voltage	450V	Material	Polycarbonate
Rated Current	16A	Dimension	120x35x50mm



SKU *250V 2-Way 3-Way
6647 6648



TRIPOD FOR FLOODLIGHTS

With CrossBar

Body Color	Black , Yellow
Material	Iron
Dimension	157x64x64mm
Height Adjustment	64-157cm
Sections	3 Pcs



SKU Black Yellow
6686 6687

TERMINAL BLOCK Professional

Metal -Waterproof Box IP68

Rated Voltage	450V	Material	Cast Alu
Rated Current	24A	Dimension	80x75x60mm



SKU 2-Way 3-Way 4-Way 4-X-Way
6509 6510 6511 6512



FLOODLIGHTSPIKE

Aluminium



SKU 160x35cm 265x55cm
6682 6683

BILLBOARD STAND

Iron



SKU 150x500cm 200x800cm
6684 6685

TERMINAL BLOCKSPLITER

Waterproof Box IP68

Rated Voltage	450V	Material	Polycarbonate
Rated Current	24A	Wire Range	0.5-4mm ²



SKU *250V 2-Way 3-Way 4-Way 4-X-Way
6643 6644 6645 6646





LED Street and Industrial Light

LED industrial lights are engineered for efficiency, durability, and performance, making them the ideal solution for demanding environments such as warehouses, factories, and production facilities. Available in multiple designs—from high bays and low bays to linear fixtures—they deliver powerful illumination while reducing energy and maintenance costs. Built to meet strict industry standards, they ensure reliable lighting for every application.

Features:

- Up to 80% energy savings compared to conventional lighting
- Wide variety of shapes and fixture types (high bay, low bay, linear, bulb)
- Extended lifespan with consistent reliability
- Multiple mounting options for easy installation
- Designed and certified to meet industrial standards

Applications:

- Warehouses and logistics centers
- Factories, workshops, and production sites
- Heavy-duty industrial environments
- Specialized lighting setups for large-scale operations

NEW



LED SOLAR STREET LIGHT

Solar Power +Remote +PIR Sensor

Body Color	Black
Beam Angle	120°
CRI	Ra>70
IP Rating	IP65
Dimmable	No



SKU	EQ.Watt	Lumen	Battery	Color	Dimension
9145	8W	1200lm	5V 8AH	6000K	413x231x47mm
9146	12W	1800lm	5V 12AH	6000K	511x231x47mm
9147	20W	2700lm	5V 18AH	6000K	722x251x47mm



LED SOLAR STREET LIGHT

Solar Power +Remote +PIR Sensor

Body Color	Black
Beam Angle	120°
CRI	Ra>70
IP Rating	IP65
Dimmable	No



SKU	EQ.Watt	Lumen	Battery	Color	Dimension
9126	8W	500lm	3.2V 5AH	6000K	390x193x47mm
9127	12W	1200lm	3.2V 10AH	6000K	484x218x53mm
9128	15W	1800lm	3.2V 15AH	6000K	620x237x54mm

NEW



LED SOLAR STREET LIGHT

Remote +PIR Sensor +USB-C for Charging

Body Color	Black
Beam Angle	120°
CRI	Ra>70
IP Rating	IP65
Dimmable	No



SKU	Solar Panel	Lumen	Battery	Color	Dimension
9291	8W	1500lm	5V 8AH	6000K	343x192x72mm
9292	12W	2250lm	5V 12AH	6000K	454x216x72mm
9293	18W	2800lm	5V 15AH	6000K	525x243x72mm
9294	24W	3600lm	5V 20AH	6000K	638x258x72mm
9295	24W	4500lm	5V 25AH	6000K	638x258x72mm

NEW



LED SOLAR STREET LIGHT

Solar Power +Remote

Body Color	Black
Beam Angle	60°
CRI	Ra>70
IP Rating	IP66
Dimmable	No

SKU	EQ.Watt	Lumen	Battery	Color	Dimension
9141	30W	4300lm	3.2V30AH	6000K	413x231x47mm
9142	40W	5200lm	3.2V 35AH	6000K	511x231x47mm
9143	50W	6300lm	3.2V 45AH	6000K	722x251x47mm

NEW



LED STREET LIGHT	
PREMIUM LINE	
High Lumens PF>0.9	
Input Voltage	180-265V 50/60Hz
Beam Angle	75x130°
CRI	Ra>70
IP Rating	IP65
Dimmable	No

SKU	Watt	Lumen	Lumen/W	Colour	Dimension
9250	30W	3600lm	120lm/W	6000K	ø270x91mm
9251	30W	3600lm	120lm/W	4000K	ø270x91mm
9252	30W	3600lm	120lm/W	3000K	ø270x91mm
9241	50W	6000lm	120lm/W	6000K	456x120x83mm
9242	50W	6000lm	120lm/W	4000K	456x120x83mm
9243	50W	6000lm	120lm/W	3000K	456x120x83mm
9244	100W	12000lm	120lm/W	6000K	527x144x83
9245	100W	12000lm	120lm/W	4000K	ø270x91mm
9246	100W	12000lm	120lm/W	3000K	ø270x91mm
9247	200W	24000lm	120lm/W	6000K	ø270x91mm
9248	200W	24000lm	120lm/W	4000K	ø270x91mm
9249	200W	24000lm	120lm/W	3000K	ø270x91mm



LED STREET LIGHT	
PREMIUM LINE	
High Lumens -Moso Driver PF>0.9	
Input Voltage	100-240V 50/60Hz
Beam Angle	120°
CRI	Ra>70
IP Rating	IP66
Dimmable	No



SKU	Watt	Lumen	Lumen/W	Colour	Dimension
9196	80W	11200lm	140lm/W	5700K	573x235x85mm
9197	100W	14000lm	140lm/W	5700K	585x235x85mm
9198	150W	21000lm	140lm/W	5700K	773x236x100mm
9199	180W	25200lm	140lm/W	5700K	773x236x100mm

NEW



LED STREET LIGHT	
PREMIUM LINE	
High Lumens PF>0.9	
Input Voltage	180-265V 50/60Hz
Beam Angle	75x130°
CRI	Ra>70
IP Rating	IP65
Dimmable	No

SKU	Watt	Lumen	Lumen/W	Color	Dimension
9227	100W	15000lm	150lm/W	6000K	404x206x70mm
9225	100W	15000lm	150lm/W	4000K	404x206x70mm
9228	150W	22500lm	150lm/W	6000K	492x248x76mm
9226	150W	22500lm	150lm/W	4000K	492x248x76mm
9229	200W	30000lm	150lm/W	6000K	574x275x76mm



NEMA Photocell (ON/OFF)

LED STREET LIGHT	
PREMIUM LINE	
Moso Driver -Bridgelux 0-10VDimmable	
Input Voltage	100-240V 50/60Hz
Beam Angle	120°
CRI	Ra>70
IP Rating	IP66
Dimmable	YES (0-10V)
Color	6000K



SKU	Watt	Lumen	Lumen/W	Photocell	Dimension
9189	75W	10500lm	140lm/W	No	580x280x190mm
9194	75W	10500lm	140lm/W	Yes	580x280x190mm
9190	100W	13500lm	135lm/W	No	580x280x190mm
9195	100W	13500lm	135lm/W	Yes	580x280x190mm
9192	200W	26000lm	130lm/W	No	580x280x190mm



LED STREET LIGHT	
PREMIUM LINE	
High Lumens PF>0.9	
Input Voltage	220-240V 50/60Hz
Beam Angle	120°
CRI	Ra>70
IP Rating	IP65
Dimmable	No



SKU	Watt	Lumen	Lumen/W	Color	Dimension
9181	150W	14250lm	95lm/W	6000K	705x365x156mm
9182	200W	19000lm	95lm/W	6000K	315x105x115mm



LED STREET LIGHT	
2PCSBOX -PF>0.9	
Input Voltage	220-240V 50/60Hz
Beam Angle	120°
CRI	Ra>70
IP Rating	IP65
Dimmable	No



SKU	Watt	Lumen	Lumen/W	Color	Dimension
9171	20W	200lm	100lm/W	6000K	300x105x50mm
9172	50W	5000lm	100lm/W	6000K	405x160x50mm
9173	80W	8000lm	100lm/W	6000K	500x190x70mm



LED STREET LIGHT	
PREMIUM LINE	
High Lumen -Moso Driver	
Input Voltage	220-240V 50/60Hz
Beam Angle	120°
CRI	Ra>70
IP Rating	IP65
Dimmable	No



SKU	Watt	Lumen	Lumen/W	Color	Dimension
9180	120W	18000lm	150lm/W	6000K	650x160x76mm

LED STREET LIGHT ADAPTERS

Matt Grey



SKU 9117
ø80mm to ø60mm



SKU 9118
ø60mm to ø45mm



SKU 9119
ADJUSTABLE ANGLE 90°
ø60mm-ø60mm



LED STREET LIGHT	
PREMIUM LINE	
High Lumen -Surge Protection	
Input Voltage	100-240V 50/60Hz
Beam Angle	120°
CRI	Ra>70
IP Rating	IP65
Dimmable	No



SKU	Watt	Lumen	Lumen/W	Color	Dimension
9157	50W	7500lm	150lm/W	5700K	494x155x76mm



NEW



LED STREET LIGHT	
Slim Line PF>0.9	
Input Voltage	180-265V 50/60Hz
Beam Angle	75x130°
CRI	Ra>70
IP Rating	IP65
Dimmable	No

SANAN
CHIP
75x130°
3 Years Warranty

SKU	Watt	Lumen	Lumen/W	Color	Dimension
9231	30W	3000lm	100lm/W	6000K	424x76x108mm
9232	30W	3000lm	100lm/W	4000K	424x76x108mm
9233	50W	5000lm	100lm/W	6000K	508x76x108mm
9234	50W	5000lm	100lm/W	4000K	508x76x108mm
9235	100W	10000lm	100lm/W	6000K	597x76x108mm
9236	100W	10000lm	100lm/W	4000K	597x76x108mm



LED STREET LIGHT	
Adjusting Angle PF>0.9	
Input Voltage	180-265V 50/60Hz
Beam Angle	75x135°
CRI	Ra>70
IP Rating	IP65
Dimmable	No

3 Years Warranty
75x130°

SKU	Watt	Lumen	Lumen/W	Color	Dimension
9216	20W	2000lm	100lm/W	6000K	438x128mm
9217	20W	2000lm	100lm/W	4500K	438x128mm
9218	20W	2000lm	100lm/W	2700K	438x128mm
9201	30W	3000lm	100lm/W	6000K	438x128mm
9202	30W	3000lm	100lm/W	4500K	438x128mm
9203	30W	3000lm	100lm/W	2700K	438x128mm
9210	150W	15000lm	100lm/W	6000K	638x210mm
9212	150W	15000lm	100lm/W	2700K	638x210mm
9213	200W	20000lm	100lm/W	6000K	695x235mm

NEW



LED STREET LIGHT	
Slim Line -Sensor Day/NightPF>0.9	
Input Voltage	180-265V 50/60Hz
Beam Angle	75x130°
CRI	Ra>70
IP Rating	IP65
Dimmable	No

SANAN
CHIP
Day/Night
3 Years Warranty

SKU	Watt	Lumen	Lumen/W	Color	Dimension
9237	30W	3000lm	100lm/W	4000K	424x76x108mm
9238	30W	3000lm	100lm/W	4000K	508x76x108mm
9239	50W	5000lm	100lm/W	4000K	597x76x108mm



LED STREET LIGHT	
Grey Body Color PF>0.9	
Input Voltage	220-240V 50/60Hz
Beam Angle	75x135°
CRI	Ra>70
IP Rating	IP65
Dimmable	No

3 Years Warranty
75x130°

SKU	Watt	Lumen	Lumen/W	Color	Dimension
9221	50W	5000lm	100lm/W	6000K	400x153x76mm
9222	100W	10000lm	100lm/W	6000K	500x196x76mm
9223	150W	15000lm	100lm/W	6000K	542x214x76mm
9224	200W	20000lm	100lm/W	6000K	609x234x76mm



LED INDUSTRIAL LIGHT

PREMIUM LINE
UFO HighBay PF>0.9

Input Voltage	180-265V 50/60Hz
Beam Angle	90°
CRI	Ra>70
IP Rating	IP65
Dimmable	No



SKU	Watt	Lumen	Lumen/W	Color	Dimension
8227	100W	15000lm	150lm/W	6000K	ø270x91mm
8248	100W	15000lm	150lm/W	4000K	ø270x91mm
8228	150W	30000lm	150lm/W	6000K	ø270x91mm
8249	150W	30000lm	150lm/W	4000K	ø270x91mm
8229	200W	45000lm	150lm/W	6000K	ø300.96.5 mm
8250	200W	45000lm	150lm/W	4000K	ø300x96.5mm

NEW



HANGING ACCESSORIES
FOR SKU: 8251-8258-1m

SKU 7506



LED INDUSTRIAL LIGHT

Linear High Bay -Aluminium -IK08

Input Voltage	220-240V 50/60Hz
Beam Angle	120x60°
CRI	Ra>80
IP Rating	IP44
Dimmable	No

SKU	Watt	Lumen	Lumen/W	Color	Dimension
8251	50W	5000lm	100lm/W	6000K	343x118x92mm
8252	50W	5000lm	100lm/W	4000K	343x118x92mm
8253	100W	10000lm	100lm/W	6000K	603x118x92mm
8254	100W	10000lm	100lm/W	4000K	603x118x92mm
8255	150W	15000lm	100lm/W	6000K	885x118x92mm
8256	150W	15000lm	100lm/W	4000K	885x118x92mm
8257	200W	20000lm	100lm/W	6000K	1134x118x92mm
8258	200W	20000lm	100lm/W	4000K	1134x118x92mm



LED INDUSTRIAL LIGHT

PREMIUM LINE
UFO HighBay PF>0.9

Input Voltage	180-265V 50/60Hz
Beam Angle	90°
CRI	Ra>70
IP Rating	IP65
Dimmable	No

SKU	Watt	Lumen	Lumen/W	Color	Dimension
8190	100W	18000lm	180lm/W	5700K	ø307x156mm
8191	150W	27000lm	180lm/W	5700K	ø307x156mm
8192	200W	36000lm	180lm/W	5700K	ø380x180mm
8193	UBRACKETFOR CEILING MOUNTING for SKU:8190-8192				
8194	UBRACKETFOR WALL MOUNTING for SKU:8190-8192				
8195	SECURITY CABLE for SKU:8190-819				



LED INDUSTRIAL LIGHT

Linear HighBay

Input Voltage	220-240V 50/60Hz
Beam Angle	120x60°
CRI	Ra>70
IP Rating	IP44
Dimmable	No

SKU	Watt	Lumen	Lumen/W	Color	Dimension
8151	50W	5000lm	100lm/W	6000K	315x105x115mm
8152	50W	5000lm	100lm/W	4500K	315x105x115mm
8153	100W	10000lm	100lm/W	6000K	570x105x115mm
8154	100W	10000lm	100lm/W	4500K	570x105x115mm
8155	150W	15000lm	100lm/W	6000K	845x105x115mm
8156	150W	15000lm	100lm/W	4500K	845x105x115mm
8157	200W	20000lm	100lm/W	6000K	1110x105x115mm
8158	200W	20000lm	100lm/W	4500K	1110x105x115mm



LED INDUSTRIAL LIGHT

UFO HighBay PF>0.9

Input Voltage	220-240V 50/60Hz
Beam Angle	90°
CRI	Ra>70
IP Rating	IP65
Dimmable	No

SKU	Watt	Lumen	Lumen/W	Color	Dimension
8201	50W	5000lm	100lm/W	6000K	ø210x56mm
8202	50W	5000lm	100lm/W	4500K	ø210x56mm
8203	100W	10000lm	100lm/W	6000K	ø259x561mm
8204	100W	10000lm	100lm/W	4500K	ø259x561mm
8205	150W	15000lm	100lm/W	6000K	ø309x56mm
8206	150W	15000lm	100lm/W	4500K	ø309x56mm
8207	200W	20000lm	100lm/W	6000K	ø359x56mm
8208	200W	20000lm	100lm/W	4500K	ø359x56mm



LED INDUSTRIAL LIGHT

High Bay PF>0.9

Input Voltage	220-240V 50/60Hz
Beam Angle	90°
CRI	Ra>70
IP Rating	IP65
Dimmable	No

SKU	Watt	Lumen	Lumen/W	Color	Dimension
8221	100W	10000lm	100lm/W	6000K	200x200x103mm
8222	100W	10000lm	100lm/W	4500K	200x200x103mm
8223	150W	15000lm	100lm/W	6000K	260x260x105mm
8224	150W	15000lm	100lm/W	4500K	260x260x105mm
8225	200W	20000lm	200lm/W	6000K	320x320x111mm
8226	200W	20000lm	200lm/W	4500K	320x320x111mm



LED INDUSTRIAL LIGHT

UFO HighBay PF>0.9

Input Voltage	220-240V 50/60Hz
Beam Angle	120°
CRI	Ra>70
IP Rating	IP65
Dimmable	No

SKU	Watt	Lumen	Lumen/W	Color	Dimension
8211	50W	5000lm	100lm/W	6000K	ø210x56mm
8212	50W	5000lm	100lm/W	4500K	ø210x56mm
8213	100W	10000lm	100lm/W	6000K	ø259x561mm
8214	100W	10000lm	100lm/W	4500K	ø259x561mm
8215	150W	15000lm	100lm/W	6000K	ø309x56mm
8216	150W	15000lm	100lm/W	4500K	ø309x56mm
8217	200W	20000lm	100lm/W	6000K	ø359x56mm
8218	200W	20000lm	100lm/W	4500K	ø359x56mm



LED INDUSTRIAL LIGHT

High Bay Slim Line -PF>0.9

Input Voltage	220-240V 50/60Hz
Beam Angle	90°
CRI	Ra>70
IP Rating	IP65
Dimmable	No

SKU	Watt	Lumen	Lumen/W	Color	Dimension
8231	50W	5000lm	100lm/W	6000K	ø226x30mm
8232	50W	5000lm	100lm/W	4500K	ø226x30mm
8234	100W	10000lm	100lm/W	4500K	ø280x30mm
8235	150W	15000lm	100lm/W	6000K	ø340x30mm
8236	150W	15000lm	100lm/W	4500K	ø340x30mm
8237	200W	20000lm	100lm/W	6000K	ø400x30mm
8238	200W	20000lm	100lm/W	4500K	ø400x30mm



SKU	Watt	Lumen	Lumen/W	Color	Dimension
8239	50W	5000lm	100lm/W	6000K	ø270x91mm
8240	50W	5000lm	100lm/W	4000K	ø270x91mm
8241	100W	10000lm	100lm/W	6000K	ø270x91mm
8242	100W	10000lm	100lm/W	4000K	ø270x91mm
8243	150W	15000lm	100lm/W	6000K	ø300.96.5mm
8244	150W	15000lm	100lm/W	4000K	ø300x96.5mm
8245	200W	20000lm	100lm/W	6000K	ø330x103mm
8246	200W	20000lm	100lm/W	4000K	ø330x103mm
8247	300W	30000lm	100lm/W	6000K	ø372x108.5mm



LED INDUSTRIAL LIGHT

UFO HighBay PF>0.9

Input Voltage	180-265V 50/60Hz
Beam Angle	120°
CRI	Ra>70
IP Rating	IP65
Dimmable	No



JOINING CABLE

SKU 7137

LED WALL WASHERS

30°

Input Voltage	220-240V 50/60Hz
Beam Angle	30°
CRI	Ra>70
IP Rating	IP65
Dimmable	No

SKU	Watt	Lumen	Lumen/W	Color	Dimension
7134	9W	700lm	78lm/W	6000K	500x30x25mm
7131	9W	700lm	78lm/W	2700K	500x30x25mm
7135	18W	1400lm	78lm/W	6000K	1000x30x25mm
7132	18W	1400lm	78lm/W	2700K	1000x30x25mm
7136	36W	3600lm	78lm/W	6000K	1000x30x25mm
7133	36W	3600lm	78lm/W	2700K	1000x30x25mm



5 Years Warranty

LED INDUSTRIAL LIGHT

PREMIUM LINE Stadium Floodlight

Input Voltage	100-240V 50/60Hz
Beam Angle	90°
CRI	Ra>70
IP Rating	IP65
Dimmable	No

SKU	Watt	Lumen	Lumen/W	Color	Dimension
9175	100W	10000lm	100lm/W	5700K	364x273x56mm
9176	150W	16500lm	110lm/W	5700K	415x308x58mm
9177	240W	26400lm	110lm/W	5700K	425x341x68mm
9178	480W	68000lm	142lm/W	5700K	649x448x68mm

NEW



IP65

LED WALL WASHER / SPOT

Spike Included

Input Voltage	180-265V 50/60Hz
Beam Angle	5°
CRI	Ra>70
IP Rating	IP65
Dimmable	No

SKU	Watt	Lumen	Lumen/W	Color	Dimension
7499	10W	800lm	80lm/W	4000K	ø133x83mm





LED Wall and Step Lights

Bring style and safety to your outdoor spaces with LED wall and step lights. Built to withstand all weather conditions, they combine robust construction with energy-efficient technology, ensuring reliable performance year-round. Available in a variety of shapes and finishes, these lights don't just illuminate—they also create stylish accents for both modern and classic settings.

Features:

- Up to 80% energy savings compared to traditional lighting
- Durable design for outdoor use in homes, gardens, and parks
- Wide choice of forms, shapes, and colours
- Options for discrete accent lighting, spot lighting, or main illumination
- Easy installation with long service life
- Available with or without integrated bulbs

Applications:

- Wall or pylon-mounted installations
- Pathways, lanes, alleys, and stairways
- Decorative lighting for gardens, courtyards, and parks
- Enhancing safety in outdoor residential or public areas



	White	White	Black	Black	Grey	Grey
SKU	7506	7505	7504	7503	7508	7507
Color	4200K	3000K	4200K	3000K	4200K	3000K

LED WALL/STEPS LIGHT			
2W -Round -IP65			
Power	2W	Beam Angle	55°
Input Voltage	AC220-240V 50Hz	CRI	Ra>80
Lumens	80lm	IP Rating	IP65
Size	ø150x27 mm	Dimmable	No



	Black	Black	Gray	Gray	White	White
SKU	7556	7555	7558	7557	7560	7559
Color	4000K	3000K	4000K	3000K	4000K	3000K

LEDSTEPS LIGHT			
1W -PIR Sensor			
Power	1W	Beam Angle	90°
Input Voltage	AC85-265V 50Hz	CRI	Ra>80
Lumens	80lm	IP Rating	IP20
Size	86x86x30mm	Dimmable	No

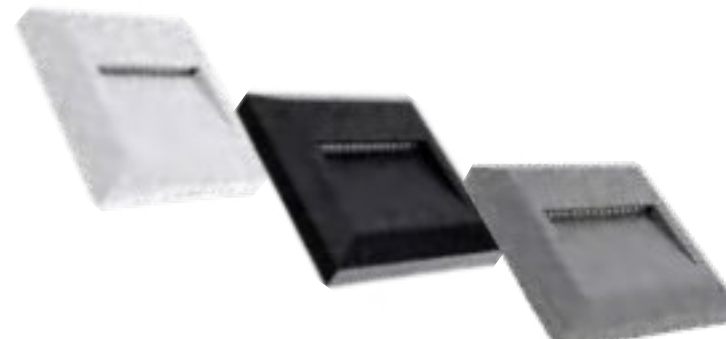

	White	White	Black	Black	Grey	Grey
SKU	7512	7511	7510	7509	7514	7513
Color	4200K	3000K	4200K	3000K	4200K	3000K

LED WALL/STEPS LIGHT			
2W -Square -IP65			
Power	2W	Beam Angle	55°
Input Voltage	AC220-240V 50Hz	CRI	Ra>80
Lumens	80lm	IP Rating	IP65
Size	124x124x27mm	Dimmable	No



	Black	Black	White	White
SKU	7548	7547	7550	7549
Color	4200K	3000K	4200K	3000K

LEDSTEPS LIGHT			
3W -Square			
Power	3W	Beam Angle	75°
Input Voltage	AC220-240V 50Hz	CRI	Ra>80
Lumens	180lm	IP Rating	IP65
Size	10x45x58mm	Dimmable	No



	White	White	Black	Black	Grey	Grey
SKU	7518	7517	7516	7515	7520	7519
Color	4200K	3000K	4200K	3000K	4200K	3000K

LED WALL/STEPS LIGHT			
3W -Rectangular -IP65			
Power	3W	Beam Angle	65°
Input Voltage	AC220-240V 50Hz	CRI	Ra>80
Lumens	100lm	IP Rating	IP65
Size	230x80x28mm	Dimmable	No



	Round	Round	Square	Square
SKU	7523	7522	7525	7524
Color	4200K	3000K	4200K	3000K

LEDSTEPS LIGHT			
3W -Round/Square			
Power	3W	Beam Angle	34°
Input Voltage	AC220-240V 50Hz	CRI	Ra>80
Lumens	90lm	IP Rating	IP20
Size	ø80x51mm	Dimmable	No





	White	White	Black	Black	Grey	Grey
SKU	7454	7451	7455	7452	7456	7453
Color	4000K	3000K	4000K	3000K	4000K	3000K

LED WALL LIGHT			
6W -Square -IP54			
Power	6W	Beam Angle	0-90°
Input Voltage	AC220-240V 50Hz	CRI	Ra>80
Lumens	660lm	IP Rating	IP54
Size	100x100x100mm	Dimmable	No



	White	White	Black	Black	Grey	Grey
SKU	7478	7475	7479	7476	7480	7477
Color	4000K	3000K	4000K	3000K	4000K	3000K

LED WALL LIGHT 1 HEAD			
6W -Rotatable -IP54			
Power	6W	Beam Angle	120°
Input Voltage	AC220-240V 50Hz	CRI	Ra>80
Lumens	660lm	IP Rating	IP54
Size	110x54x97mm	Dimmable	No



	White	White	Black	Black	Grey	Grey
SKU	7460	7457	7461	7458	7462	7459
Color	4000K	3000K	4000K	3000K	4000K	3000K

LED WALL LIGHT			
12W -Square -IP54			
Power	12W	Beam Angle	0-90°
Input Voltage	AC220-240V 50Hz	CRI	Ra>80
Lumens	1320lm	IP Rating	IP54
Size	100x100x100mm	Dimmable	No



	White	White	Black	Black	Grey	Grey
SKU	7484	7481	7485	7482	7486	7483
Color	4000K	3000K	4000K	3000K	4000K	3000K

LED WALL LIGHT 2 HEADS			
2x6W -Rotatable -IP54			
Power	12W	Beam Angle	120°
Input Voltage	AC220-240V 50Hz	CRI	Ra>80
Lumens	1320lm	IP Rating	IP54
Size	221x54x97mm	Dimmable	No



	White	White	Black	Black	Grey	Grey
SKU	7466	7463	7467	7464	7468	7465
Color	4000K	3000K	4000K	3000K	4000K	3000K

LED WALL LIGHT			
6W -Round -IP54			
Power	6W	Beam Angle	0-90°
Input Voltage	AC220-240V 50Hz	CRI	Ra>80
Lumens	660lm	IP Rating	IP54
Size	140x115x100 mm	Dimmable	No



	White	White	Black	Black	Grey	Grey
SKU	7472	7469	7473	7470	7474	7471
Color	4000K	3000K	4000K	3000K	4000K	3000K

LED WALL LIGHT			
6W -Triangle -IP54			
Power	6W	Beam Angle	15-90°
Input Voltage	AC220-240V 50Hz	CRI	Ra>80
Lumens	660lm	IP Rating	IP54
Size	90x90x200 mm	Dimmable	No

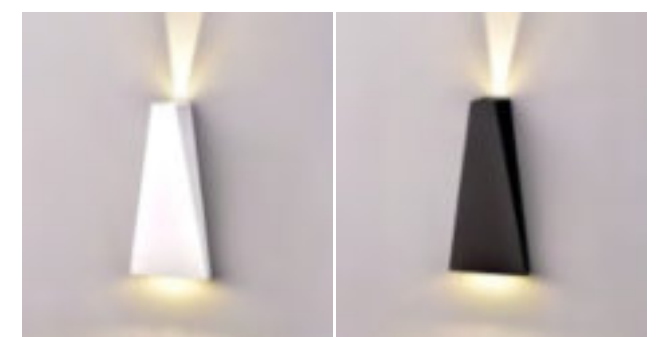



	White	White	Black	Black	Grey	Grey
SKU	7490	7487	7491	7488	7492	7489
Color	4000K	3000K	4000K	3000K	4000K	3000K

LED WALL LIGHT			
4W -Round -4 Beam -IP54			
Power	4W	Beam Angle	90°
Input Voltage	AC220-240V 50Hz	CRI	Ra>80
Lumens	440lm	IP Rating	IP54
Size	ø110x93 mm	Dimmable	No

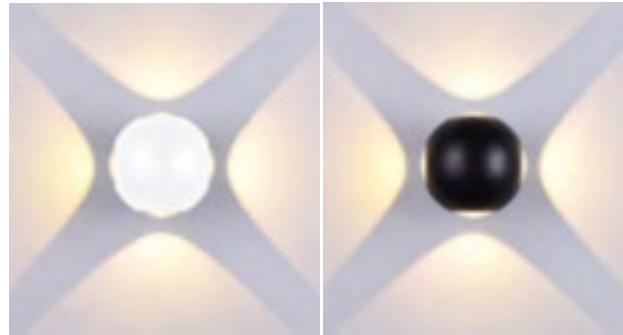

	White	Black
SKU	2089	2090
Color	3000K	3000K

LED WALL LIGHT			
12W -Plastic -IP65			
Power	12W	Beam Angle	90°
Input Voltage	AC220-240V 50Hz	CRI	Ra>80
Lumens	1200lm	IP Rating	IP65
Size	ø160x60 mm	Dimmable	No



	White	White	Black	Black	Grey	Grey
SKU	7496	7493	7497	7494	7498	7495
Color	4000K	3000K	4000K	3000K	4000K	3000K

LED WALL LIGHT			
6W -Round -2 Beam -IP54			
Power	6W	Beam Angle	90°
Input Voltage	AC220-240V 50Hz	CRI	Ra>80
Lumens	660lm	IP Rating	IP54
Size	ø110x93 mm	Dimmable	No

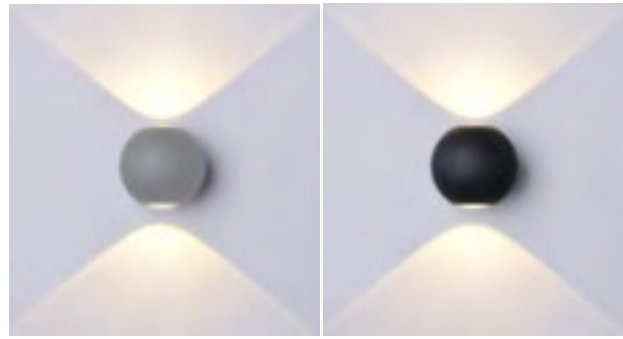

	White	Black
SKU	2091	2092
Color	3000K	3000K

LED WALL LIGHT			
12W -Aluminium -IP65			
Power	12W	Beam Angle	90°
Input Voltage	AC220-240V 50Hz	CRI	Ra>80
Lumens	670lm	IP Rating	IP65
Size	ø150x46 mm	Dimmable	No



	Round	Round	Square	Square
SKU	7529	7528	7531	7530
Color	4200K	3000K	4200K	3000K

LED WALL /CEILING LIGHT			
12W -IP65			
Power	12W	Beam Angle	120°
Input Voltage	AC220-240V 50Hz	CRI	Ra>80
Lumens	850lm	IP Rating	IP65
Size	ø172x103mm 165x165x103mm	Dimmable	No



	Round	Round	Square	Square
SKU	7533	7532	7535	7534
Color	4200K	3000K	4200K	3000K

LED WALL /CEILING LIGHT			
12W -IP65			
Power	12W	Beam Angle	145°
Input Voltage	AC220-240V 50Hz	CRI	Ra>80
Lumens	850lm	IP Rating	IP65
Size	ø170x105mm 160x160x102mm	Dimmable	No





LED WALL LIGHT

Black -IP65

Input Voltage	AC220-240V50Hz	Beam Angle	48°
Dimmable	No	CRI	Ra>80

SKU	Watt	Lumen	Colour	Dimension
-----	------	-------	--------	-----------

7407	2Lens4W	340lm	3000K	106x80x38mm
7409	3Lens6W	510lm	3000K	158x80x40mm
7411	4Lens8W	680lm	3000K	210x80x48mm



SKU	7527	7526
Color	4200K	3000K

LED WALL LIGHT -BULKHEAD

12W -Rectangle

Power	12W	Beam Angle	120°
Input Voltage	AC220-240V 50Hz	CRI	Ra>80
Lumens	550lm	IP Rating	IP65
Size	230x110x76mm	Dimmable	No



LED WALL LIGHT

White -IP65

Input Voltage	AC220-240V50Hz	Beam Angle	48°
Dimmable	No	CRI	Ra>80

SKU	Watt	Lumen	Colour	Dimension
-----	------	-------	--------	-----------

7408	2Lens4W	340lm	3000K	106x80x38mm
7410	3Lens6W	510lm	3000K	158x80x40mm
7412	4Lens8W	680lm	3000K	210x80x48mm



SKU	7422	7423
Color	Stainless Steel	Stainless Steel

WALL LIGHT FITTING

E27 Fitting

Socket	1xE27	Material	Aluminium
Input Voltage	AC220-240V 50Hz	Max Power	60W
Size	303x100x91mm	IP Rating	IP54



SKU	7404	7403
Color	4000K	3000K



LED WALL /CEILING LIGHT

9W -Cree Chip

Power	9W	Beam Angle	6°
Input Voltage	AC220-240V 50Hz	CRI	Ra>80
Lumens	780lm	IP Rating	IP54
Size	163x100x50mm	Dimmable	No

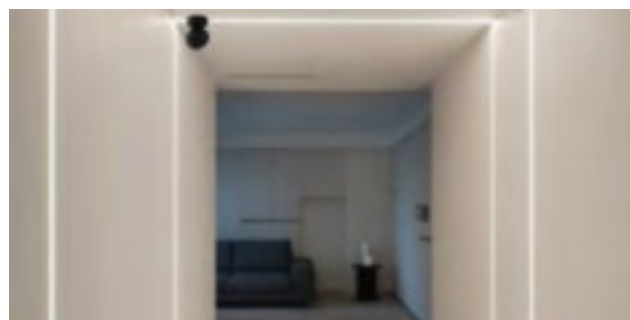

SKU	7402	7401
Color	White	Black

WALL LIGHT FITTING

E27 Fitting

Socket	1xE27	Material	Alu+Glass
Input Voltage	AC220-240V 50Hz	Max Power	60W
Size	245x180x93mm	IP Rating	IP44

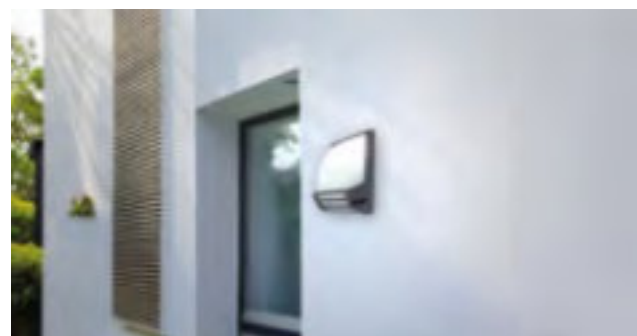

NEW



SKU 7536
Color Grey

WALL LIGHT FITTING			
E27 Fitting			
Socket	1xE27	Material	Aluminium
Input Voltage	AC220-240V 50Hz	Max Power	40W
Size	230x100x104mm	IP Rating	IP54



NEW



SKU 2830
Color 3000K

LED WALL /SURFACE LIGHT			
Round -Aluminium			
Power	24W	Beam Angle	120°
Input Voltage	AC110-240V 50Hz	CRI	Ra>80
Lumens	2400lm	IP Rating	IP65
Size	ø255x65mm	Dimmable	No



NEW



SKU 7537
Color Grey

WALL LIGHT FITTING			
E27 Fitting			
Socket	1xE27	Material	Aluminium
Input Voltage	AC220-240V 50Hz	Max Power	40W
Size	220x90x87mm	IP Rating	IP54



NEW



SKU 2829
Color 3000K

LED WALL /SURFACE LIGHT			
Round -Aluminium			
Power	30W	Beam Angle	120°
Input Voltage	AC100-240V 50Hz	CRI	Ra>80
Lumens	3000lm	IP Rating	IP65
Size	ø225x55mm	Dimmable	No



NEW



SKU 7538
Color Gray

WALL LIGHT FITTING			
E27 Fitting			
Socket	1xE27	Material	Alu+Glass
Input Voltage	AC220-240V 50Hz	Max Power	40W
Size	245x180x93mm	IP Rating	IP54

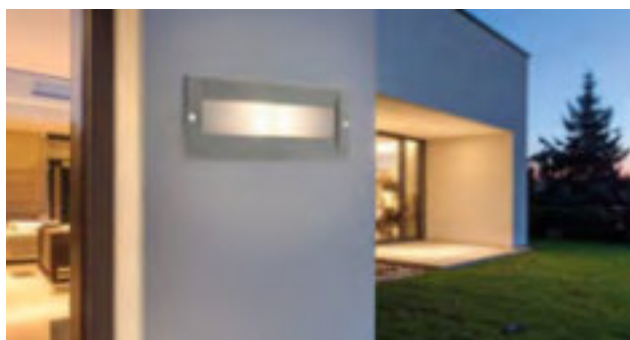

NEW



White White
SKU 7502 7501
Color 4200K 3000K

LED WALL/STEPS LIGHT			
6W -Rectangular -IP65			
Power	6W	Beam Angle	75°
Input Voltage	AC220-240V 50Hz	CRI	Ra>80
Lumens	480 lm	IP Rating	IP65
Size	215x70x65mm	Dimmable	No





WALL LIGHT FITTING			
GU10 Fitting –Adjustable			
Socket	1xGU10	Material	Aluminium
Input Voltage	AC220–240V 50Hz	Max Power	35W
Size	100x66x92mm	IP Rating	IP44



SKU	7443	7444	7445
Color	Black	White	Silver



WALL LIGHT FITTING			
GU10 Fitting			
Socket	1xGU10	Material	Aluminium
Input Voltage	AC220–240V 50Hz	Max Power	35W
Size	65x81x92mm	IP Rating	IP54



SKU	7431	7432	7433	7449
Color	Black	White	Silver	Polished



WALL LIGHT FITTING			
GU10 Fitting –Adjustable			
Socket	1xGU10	Material	Aluminium
Input Voltage	AC220–240V 50Hz	Max Power	35W
Size	68x81x92mm	IP Rating	IP54

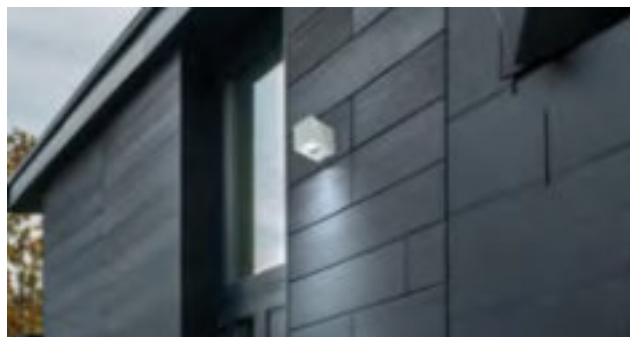

SKU	7434	7435	7436
Color	Black	White	Silver



WALL LIGHT FITTING			
GU10 Fitting –Up and Down			
Socket	2xGU10	Material	Aluminium
Input Voltage	AC220–240V 50Hz	Max Power	2x35W
Size	68x92x150mm	IP Rating	IP54



SKU	7437	7438	7439	7450
Color	Black	White	Silver	Polished



WALL LIGHT FITTING			
GU10 Fitting –Up and Down			
Socket	2xGU10	Material	Aluminium
Input Voltage	AC220–240V 50Hz	Max Power	2x35W
Size	92x68x150mm	IP Rating	IP54

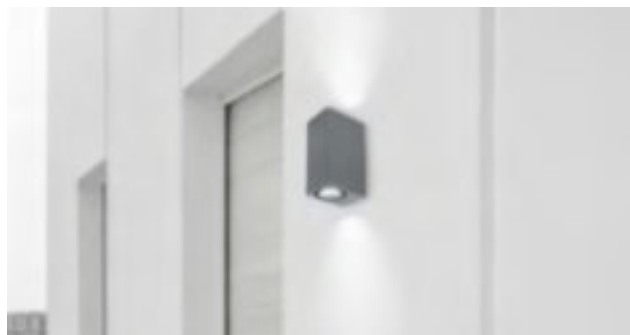

SKU	7440	7441	7442
Color	Black	White	Silver



WALL LIGHT FITTING			
GU10 Fitting –Up and Down			
Socket	2xGU10	Material	Aluminium
Input Voltage	AC220–240V 50Hz	Max Power	2x35W
Size	68x92x150mm	IP Rating	IP44

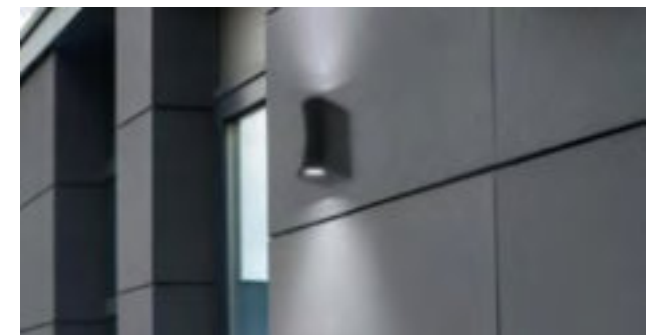

SKU	7446	7447	7448
Color	Black	White	Silver



LED Outdoor&GardenLights

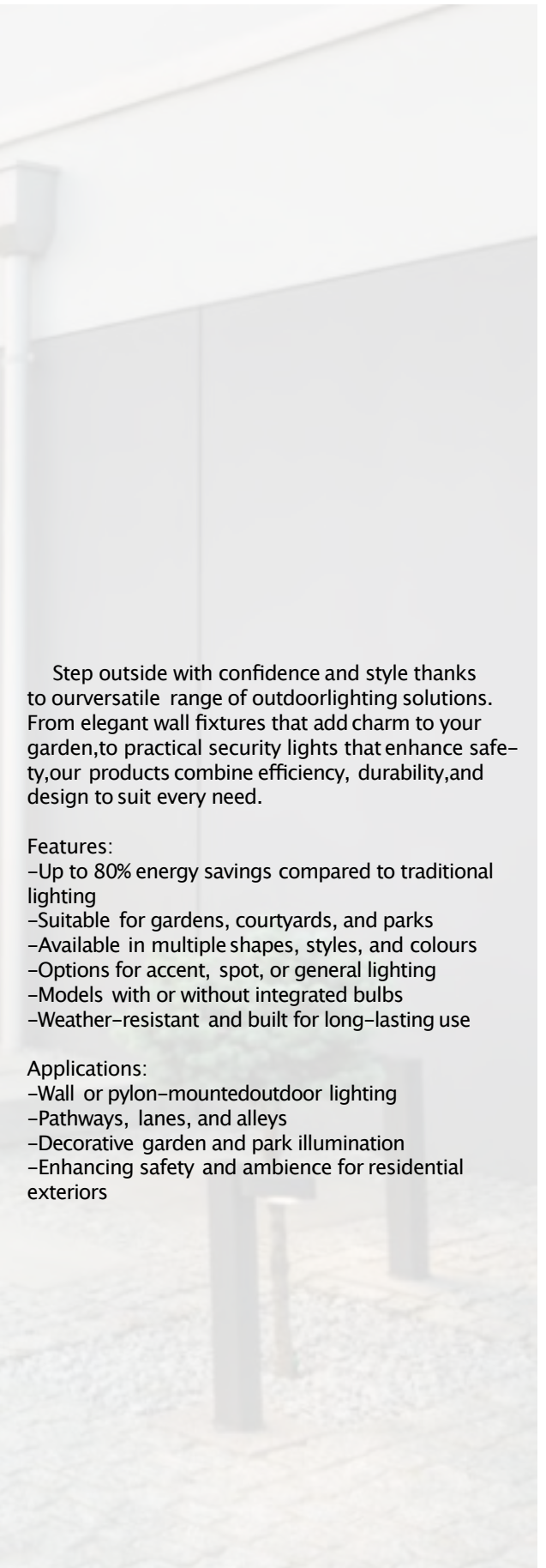

Step outside with confidence and style thanks to our versatile range of outdoor lighting solutions. From elegant wall fixtures that add charm to your garden, to practical security lights that enhance safety, our products combine efficiency, durability, and design to suit every need.

Features:

- Up to 80% energy savings compared to traditional lighting
- Suitable for gardens, courtyards, and parks
- Available in multiple shapes, styles, and colours
- Options for accent, spot, or general lighting
- Models with or without integrated bulbs
- Weather-resistant and built for long-lasting use

Applications:

- Wall or pylon-mounted outdoor lighting
- Pathways, lanes, and alleys
- Decorative garden and park illumination
- Enhancing safety and ambience for residential exteriors

NEW



WALL ANDLAWN LAMP

E27 Fitting

Socket	1xE27	Material	Alu+PC
Input Voltage	AC220-240V 50Hz	Max Power	40W
Size Wall	ø157x223mm	IP Rating	IP54
Size Lawn	ø145x350mm		
Size Lawn	ø145x750mm		

	Wall	35cm	75cm
SKU	7424	7426	7427
Color	Black	Black	Black

NEW



WALL LIGHT FITTING

GU10 Fitting

Socket	2xGU10	Material	Alu
Input Voltage	AC220-240V 50Hz	Max Power	2x35W
Size 1	99x65x155 mm	IP Rating	IP54
Size 2	75x105x180 mm		
Size 3	68x90x225 mm		

	1	2	3
SKU	7561	7562	7563
Color	Black	Black	Black



NEW



WALL ANDLAWN LAMP

E27 Fitting - PIR Sensor

Socket	1xE27	Material	Alu+PC
Input Voltage	AC220-240V 50Hz	Max Power	40W
Size Wall	ø157x223mm	IP Rating	IP54
Size Lawn	ø145x350mm	PIR	Yes
Size Lawn	ø145x750mm		

	Wall	35cm	75cm
SKU	7425	7428	7429
Color	Black	Black	Black



NEW



WALL LIGHT FITTING

GU10 Fitting

Socket	2xGU10	Material	Alu
Input Voltage	AC220-240V 50Hz	Max Power	2x35W
Size Up	99x65x155 mm	IP Rating	IP54
Size Down	75x105x180 mm		

	Up	Down
SKU	7564	7565
Color	Black	Black



NEW



PENDANT ANDPOLE LAMP

E27 Fitting

Socket	1xE27	Material	Alu+PC
Input Voltage	AC220-240V 50Hz	Max Power	40W
Size Pendant	220x220x800mm	IP Rating	IP44
Size Pole	220x300x800 mm		

	Pendant	Pole
SKU	7566	7567
Color	Black	Black

NEW



LED WALL LAMP

Aluminium/PIR Sensor*

Power	12W	Beam Angle	120°
Input Voltage	AC220-240V 50Hz	CRI	Ra>80
Lumens	1200lm	IP Rating	IP54
Size	ø130x140x190 mm	Dimmable	No

		PIR*
SKU	7414	7415
Color	3000K	3000K





SKU	9302	9301
Color	White	Black

WALL LAMP UP

E27 Fitting			
Socket	1xE27	Material	Alu+PC
Input Voltage	AC220-240V 50Hz	Max Power	60W
Size	215x170x220mm	IP Rating	IP44



SKU	9306	9305
Color	White	Black

STAND LAMP

E27 Fitting			
Socket	1xE27	Material	Alu+PC
Input Voltage	AC220-240V 50Hz	Max Power	60W
Size	170x170x290mm	IP Rating	IP44



SKU	9304	9303
Color	White	Black

WALL LAMP DOWN

E27 Fitting			
Socket	1xE27	Material	Alu+PC
Input Voltage	AC220-240V 50Hz	Max Power	60W
Size	215x170x220mm	IP Rating	IP44



	60cm	90cm	60cm	90cm
SKU	9310	9312	9309	9311
Color	White	White	Black	Black

LAWN LAMP

E27 Fitting -60cm / 90cm			
Socket	1xE27	Material	Alu+PC
Input Voltage	AC220-240V 50Hz	Max Power	60W
Size	170x170x600mm	IP Rating	IP44
Size	170x170x900mm		

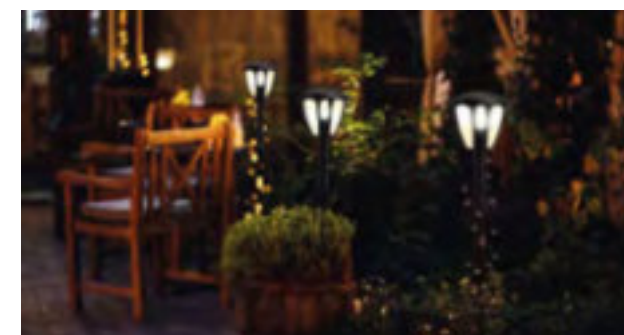

SKU	9308	9307
Color	White	Black

CEILING LAMP

E27 Fitting			
Socket	1xE27	Material	Alu+PC
Input Voltage	AC220-240V 50Hz	Max Power	60W
Size	170x170x740mm	IP Rating	IP44



	80cm	100cm
SKU	9315	9316
Color	Dark Grey	Dark Grey

LAWN LAMP

E27 Fitting -80cm / 100cm			
Socket	1xE27	Material	Alu+PC
Input Voltage	AC220-240V 50Hz	Max Power	60W
Size	80x80x805mm	IP Rating	IP54
Size	80x80x1005mm		

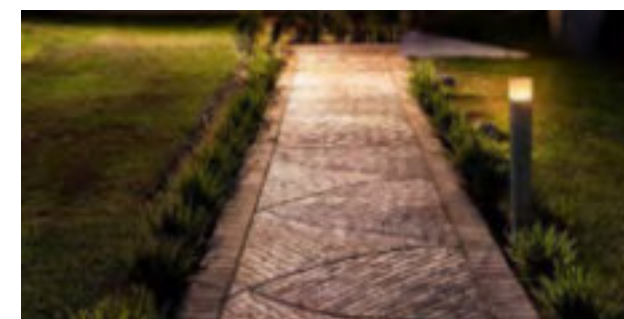



LED SOLAR WALL LIGHT
PIR Sensor

IP Rating	IP54	Beam Angle	60°
Light Color	6000K	CRI	Ra>80

SKU	Battery	Solar Panel	Lumen	Dimension
-----	---------	-------------	-------	-----------

7541	3.2V 2Ah	5.5V 1.8W	500lm	160x130x28mm
7542	3.2V 4Ah	5.5V 5W	1000lm	350x140x28mm
7543	3.2V 6Ah	5V 12.5W	1200lm	350x266x28mm



LED SOLAR WALL LIGHT
PIR Sensor

IP Rating	IP54	Beam Angle	110°
Light Color	6000K	CRI	Ra>80

SKU	Battery	Power	Lumen	Dimension
-----	---------	-------	-------	-----------

7405	5.5V 1.2Ah	0.75W	110lm	124x95x48mm
7406	7.4V 1.2Ah	1.5W	220lm	196x115x45mm



LED SOLAR WALL LIGHT
Plastic

Power	0.5W	Beam Angle	120°
Battery	3.7V 1200mAh	CRI	Ra>80
Lumens	40lm	IP Rating	IP44
Size	105x70x40mm	Dimmable	No

SKU	9352
Color	3000K



Table Way or Spike Mounted

Table Way or Wall Mounted

LED SOLAR LAWN /WALL LAMP
Solar Panel 5.5V 1W

Power	1W	Beam Angle	270°
Battery	3.7V 1200mAh	CRI	Ra>80
Lumens	60lm	IP Rating	IP54
Size Spike	180x116x740mm	Dimmable	No
Size Wall	230x116x150mm	Material	PC

	Spike	Wall
SKU	9349	9350
Color	CCT	CCT



LED SOLAR GARDEN LIGHT
Remote Control

Power	1.8W	Beam Angle	270°
Battery	3.7V 1200mAh	CRI	Ra>80
Lumens	70lm	IP Rating	IP54
Size	160x160x213mm	Dimmable	No

SKU	9351
Color	CCT



LED SOLAR WALL LAMP
PIR Sensor -Dark Gray

Power	9W	Beam Angle	110°
Battery	3.7V 2000mAh	CRI	Ra>80
Lumens	400lm	IP Rating	IP44
Size Square	180x120x127mm	Dimmable	No
Size Round	160x130x190mm	Material	Alu

	Square	Round
SKU	9347	9345
Color	3000K	3000K



LED SOLAR WALL LAMP
Plastic

Power	1W	Beam Angle	80°
Battery	3.7V 1800mAh	CRI	Ra>80
Lumens	60lm	IP Rating	IP44
Size	ø85x238mm	Dimmable	No

	White	White	Black	Black
SKU	2085	2086	2087	2088
Color	6000K	4200K	6000K	4200K





LED WALL/LAWN LIGHT			
Dark Gray			
Power	7W	Beam Angle	150°
Voltage	AC:220-240V	CRI	Ra>80
Lumens	490lm	IP Rating	IP54
Size Wall	140x110x165mm	Dimmable	No
Size Lawn	φ800x123mm	Material	Alu+PC
SKU	Wall 9343	Lawn 9344	
Color	3000K	3000K	



LED SOLAR LAMP			
PIR Sensor -Brushed Aluminium			
Power	2W	Beam Angle	110°
Battery	3.7V 1200mAh	CRI	Ra>80
Lumens	200lm	IP Rating	IP44
Size Wall	125x195x142mm	Dimmable	No
Size Spike	152x152x500mm	Material	Alu
Size Pole	152x152x800mm		
SKU	Wall 9331	Spike 9332	Pole 9333
Color	3000K	3000K	3000K



LED SOLAR LAMP			
PIR Sensor -Dark Gray			
Power	9W	Beam Angle	110°
Battery	3.7V 2000mAh	CRI	Ra>80
Lumens	400lm	IP Rating	IP44
Size Square	150x140x762 mm	Dimmable	No
Size Round	150x195x762mm	Material	Alu
SKU	Square 9348	Round 9346	
Color	3000K	3000K	



LED SOLAR LAMP			
PIR Sensor -Brushed Aluminium			
Power	4.4W	Beam Angle	110°
Battery	3.7V 2600mAh	CRI	Ra>80
Lumens	600lm	IP Rating	IP44
Size Wall	160x162x175mm	Dimmable	No
Size Spike	160x160x500mm	Material	Alu
Size Pole	160x160x800mm		
SKU	Wall 9334	Spike 9335	Pole 9336
Color	3000K	3000K	3000K



LED SOLAR LAMP			
PIR Sensor -Black			
Power	6W	Beam Angle	110°
Battery	3.7V 2200mAh	CRI	Ra>80
Lumens	600lm	IP Rating	IP44
Size Wall	161x101x210mm	Dimmable	No
Size Spike	150x150x500mm	Material	Alu
Size Pole	150x150x900mm		
SKU	Wall 9340	Spike 9341	Pole 9342
Color	3000K	3000K	3000K



LED SOLAR LAMP			
PIR Sensor -Brushed Aluminium			
Power	4.4W	Beam Angle	110°
Battery	3.7V 2600mAh	CRI	Ra>80
Lumens	600lm	IP Rating	IP44
Size Wall	150x160x160mm	Dimmable	No
Size Spike	150x150x500mm	Material	Alu
Size Pole	150x150x800mm		
SKU	Wall 9337	Spike 9338	Pole 9339
Color	3000K	3000K	3000K

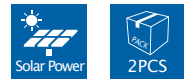

LED SOLAR LIGHTSPIKE
Solar Panel 5V 1W

Power	0.5W	Beam Angle	60°
Battery	3.2V 1200mAh	CRI	Ra>80
Lumens	90lm	IP Rating	IP65
Size	φ126x51.8mm	Dimmable	No

SKU	9357	9358	9359
Color	6000K	4000K	RGB



LED SOLAR LIGHTSPIKE
Light Brigness Control

Power	2W	Beam Angle	120°
Battery	3.7V 1800mAh	CRI	Ra>80
Lumens	160lm	IP Rating	IP65
Size	102x169x313mm	Dimmable	No

SKU	9353
Color	3000K



LED SOLAR LIGHTSPIKE
Light Brigness Control

Power	1W	Beam Angle	120°
Battery	3.7V 1200mAh	CRI	Ra>80
Lumens	80lm	IP Rating	IP65
Size	φ130x395mm	Dimmable	No

SKU	9354
Color	3000K



LED SOLAR LIGHTSPIKE
1.5W Lawn Light

Power	1.5W	Beam Angle	36°
Battery	1.2V 1500mAh	CRI	Ra>80
Lumens	60 lm	IP Rating	IP65
Size	90x330x275mm	Dimmable	No

SKU	9321	9322	9323	9324
Color	6000K	3000K	Blue	Green



Wall Mounted or Pin Mounted

LED SOLAR LIGHTSPIKE
Solar Panel Power: 5.5V 0.6W

Power	0.6W	Beam Angle	120°
Battery	3.7V 2000mAh	CRI	Ra>80
Lumens	81m	IP Rating	IP65
Size	169 x 32 mm	Dimmable	No

SKU	9355	9356
Color	CCT	RGB

NEW



LAWN LIGHT FIXTURE
GU10Socket

Socket	1xGU10	Material	PC
Input Voltage	AC220-240V 50Hz	Max Power	35W
Size	90x68x150mm	IP Rating	IP65

SKU	7413	2084
Color	Black	Black



LED GARDEN LIGHTS

NEW



GARDEN LIGHT/PARK LIGHT

Pole Not included

Power	120W	Beam Angle	90°
Input Voltage	AC160-265V 50Hz	CRI	Ra>80
Lumens	14400lm	IP Rating	IP54
Size	ø382x116mm	Dimmable	No

SKU	9360
Color	CCT



LED OUTOORLIGHT

Built-in Spotlight

Input Voltage	220-240V 50/60Hz
Beam Angle	18°
CRI	Ra>80
IP Rating	IP65
Dimmable	No

SKU	Watt	Lumen	Cut Size	Color	Dimension
507	1W	80lm	ø58	6000K	ø65x75mm
517	1W	80lm	ø58	2800K	ø65x75mm
501	3W	240lm	ø92	6000K	ø100x88mm
502	3W	240lm	ø92	2800K	ø100x88mm
515	5W	400lm	ø125	6000K	ø150x92mm
516	5W	400lm	ø115	2800K	ø120x92mm
550	7W	560lm	ø132	2800K	ø150x88mm
551	7W	560lm	ø140	6000K	ø160x92mm



LED UNDERGROUND LIGHT

Stainless Steel

Input Voltage	AC/DC 24V
Beam Angle	60°
CRI	Ra>80
IP Rating	IP68
Dimmable	No

SKU	Watt	Lumen	Cut Size	Color	Dimension
580	1W	75lm	ø17	6000K	ø24x45mm
581	1W	75lm	ø17	3000K	ø24x45mm
582	1W	75lm	ø17	BLUE	ø24x45mm
583	1.3W	80lm	ø17	6000K	ø24x45mm
584	1.3W	80lm	ø17	3000K	ø24x45mm
585	1.3W	80lm	ø17	BLUE	ø24x45mm



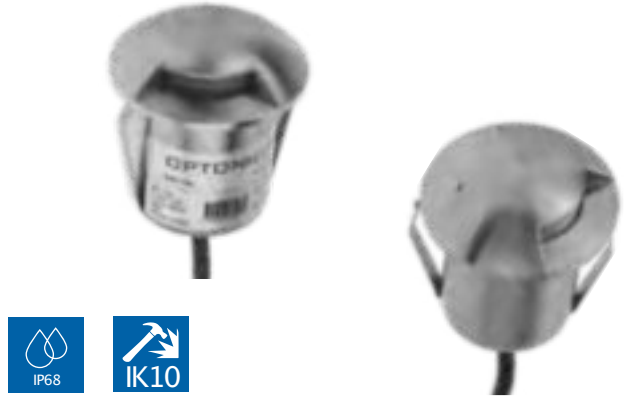

	1 Side Beam		2 Side Beam	
SKU	596	597	598	599
Color	6000K	3000K	6000K	3000K

LED UNDERGROUND LIGHT			
Stainless Steel			
Power	1.3W	Beam Angle	30°
Input Voltage	AC/DC 24V	CRI	Ra>80
Lumens	100lm	IP Rating	IP68
Size	ø40x50mm	Dimmable	No



SKU	590
Color	3000K

LED OUTDOORLIGHT			
Aluminium			
Power	1.3W	Beam Angle	45°
Input Voltage	AC/DC 24V	CRI	Ra>80
Lumens	80lm	IP Rating	IP68
Size	ø44x85mm	Dimmable	No



SKU	863	864	865	879
Color	6000K	4000K	3000K	BLUE

LED OUTDOORLIGHT			
Aluminium			
Power	1.3W	Beam Angle	60°
Input Voltage	AC/DC 24V	CRI	Ra>80
Lumens	100lm	IP Rating	IP44
Size	ø64x44mm	Dimmable	No



SKU	856
Color	4000K

LED OUTDOORLIGHT			
Aluminium			
Power	7,5W	Beam Angle	30°
Input Voltage	AC/DC 24V	CRI	Ra>80
Lumens	600lm	IP Rating	IP68
Size	ø40x50mm	Dimmable	No



SKU	592	593
Color	6000K	3000K

LED UNDERGROUND LIGHT			
Half Shading			
Power	1.3W	Beam Angle	50°
Input Voltage	AC/DC 24V	CRI	Ra>80
Lumens	80lm	IP Rating	IP68
Size	ø60x50mm	Dimmable	No



SKU	565	566	567	568
Color	RGB	Blue	Green	Amber

LED POND /WALL LIGHT			
Aluminium			
Power	1.3W	Beam Angle	270°
Input Voltage	AC/DC 24V	CRI	Ra>80
Lumens	100lm	IP Rating	IP68
Size	ø32x45mm	Dimmable	No





LED POOL LIGHT	
Stainless Steel	
Input Voltage	AC/DC 24V
Beam Angle	90°
CRI	Ra>80
IP Rating	IP68
Dimmable	No

SKU	Watt	Lumen	Cut Size	Color	Dimension
589	1W	75lm	ø26	RGB	ø38x35mm
591	1W	75lm	ø26	RGB	ø38x35mm
586	1.2W	80lm	ø26	6000K	ø38x35mm
587	1.2W	80lm	ø26	3000K	ø38x35mm
588	1.2W	80lm	ø26	BLUE	ø38x35mm
594	1.3W	80lm	ø25	6000K	ø35x30mm
595	1.3W	80lm	ø25	3000K	ø35x30mm



LED POOL LIGHT	
PAR 56	
Input Voltage	AC/DC 12V
Beam Angle	90°
CRI	Ra>80
IP Rating	IP68
Dimmable	No

SKU	Watt	Lumen	Cut Size	Color	Dimension
571	18W	1800lm	ø58	6000K	ø178x114mm
572	18W	1800lm	ø58	2800K	ø178x114mm

SKU	Watt	Lumen	Cut Size	Color	Dimension
573	18W	1800lm	ø92	RGB	ø178x114mm



NEW



SKU	518	519
Shape	Round	Square

LED OUTDOORSPOTLIGHT FIXTURE			
GU10Socket			
Socket	1xGU10	Material	Steel+PC
Input Voltage	AC220-240V 50Hz	Max Power	35W
Size	110x110x117mm	IP Rating	IP67

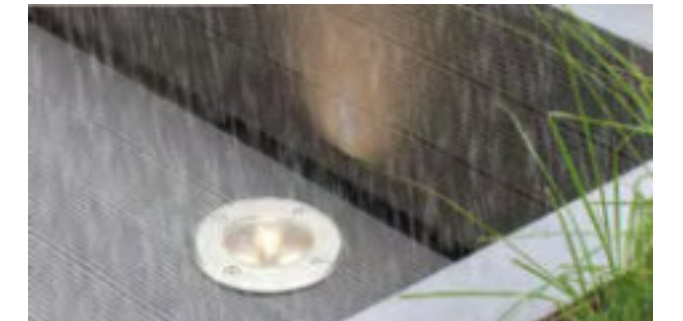

SKU	866	867	868
Color	6000K	4000K	3000K

LED OUTDOORSPIKE LIGHT			
Stainless Steel			
Power	1.3W	Beam Angle	50°
Input Voltage	AC/DC 24V	CRI	Ra>80
Lumens	100lm	IP Rating	IP68
Size	ø42x412mm	Dimmable	No



SKU	577/873	578/872	579/874
Size	22x55mm	35x150mm	55x150mm

SLEEVE FOR LED UNDERGROUNDLIGHT	
Aluminium	





LED STRING LIGHTS



OUTDOORSOLAR STRING LIGHTS

G50 Bulbs 20Pcs

Battery	3.7V 450/500mAh	Beam Angle	270°
IP Rating	IP68	CRI	Ra>80

SKU	Lumens	Type	Color	Dimension
9092	128lm	Milky	2700K	10m
9093	128lm	Clear	2700K	10m
9094	200lm	Milky	2700K	7m
9095	200lm	Clear	2700K	7m



OUTDOORSTRING LIGHTS

Linkable up to 2Strings

Input Voltage	AC220-240V 50Hz
CRI	Ra>80
IP Rating	IP65
Dimmable	No

SKU	Watt	Bulbs	Rope Color	Color	Dimension
5056	3W	10Pcs	Black	Colorful	8m
5092	6W	20 Pcs	Black	Colorful	13m
5090	3W	10 Pcs	White	Colorful	8m
5095	6W	20 Pcs	White	Colorful	13m
5057	3W	10Pcs	Black	6000K	8m
5058	3W	10Pcs	Black	2700K	8m
5093	6W	20 Pcs	Black	6000K	13m
5094	6W	20 Pcs	Black	2700K	13m
5091	3W	10 Pcs	White	2700K	8m
5096	6W	20 Pcs	White	2700K	13m



OUTDOORSTRING LIGHTS

E27 Fitting -Linkable

Input Voltage	AC220-240V 50Hz
Linkable	Up to 1000W(Max)
IP Rating	IP65
Dimmable	No

SKU	Fitting	E27 Fitting	Rope Color	Type	Dimension
5054	E27	10Pcs	Black	Suspended	6m
5051	E27	15 Pcs	Black	Suspended	14.4m
5055	E27	10 Pcs	White	Suspended	6m
5053	E27	15 Pcs	White	Suspended	13m
5052	E27	15 Pcs	Black	Fixed	14.4m

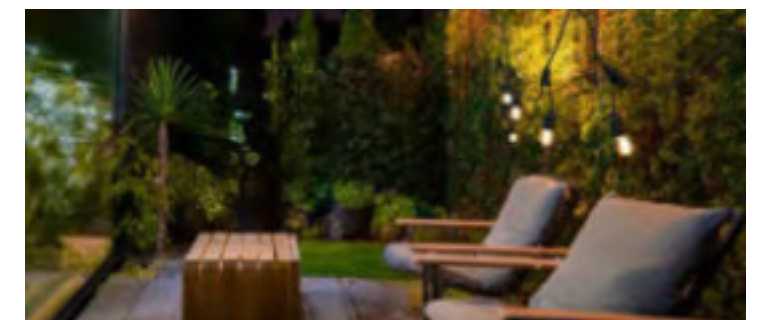



Sensors



PIR MOTIONSENSOR
Max Power -300W LED

Input Voltage	AC220-240V 50Hz	Range	6m MAX
Beam Angle	360°	Time	10sec-7min
Ambient Light	10Lux-2000Lux	Material	Plastic
Size	Φ73x60mm	IP Rating	IP20

SKU: 7320 (Black), 7321 (Silver)
Color: Black, Silver



PIR MOTIONSENSOR
Max Power -300W LED

Input Voltage	AC220-240V 50Hz	Range	6m MAX
Beam Angle	360°	Time	10sec-7min
Ambient Light	10Lux-2000Lux	Material	Plastic
Size	Φ76x45mm	IP Rating	IP20

SKU: 7317
Color: White



PIR MOTIONSENSOR
Max Power -100W LED

Input Voltage	AC220-240V 50Hz	Range	6m MAX
Beam Angle	360°	Time	10sec-7min
Ambient Light	10Lux-2000Lux	Material	Plastic
Size	Ø75x27mm	IP Rating	IP20

SKU: 7311
Color: White



PIR MOTIONSENSOR
Max Power -300W LED

Input Voltage	AC220-240V 50Hz	Range	16m MAX
Beam Angle	360°	Time	10sec-7min
Ambient Light	10Lux-2000Lux	Material	Plastic
Size	Ø88x55mm	IP Rating	IP20

SKU: 7305
Color: White



PIR MOTIONSENSOR
Max Power -1000W LED

Input Voltage	AC220-240V 50Hz	Range	8m MAX
Beam Angle	360°	Time	10sec-7min
Ambient Light	10Lux-2000Lux	Material	Plastic
Size	Ø108x25mm	IP Rating	IP20

SKU: 7310
Color: White



PIR MOTIONSENSOR
Max Power -1000W LED

Input Voltage	AC220-240V 50Hz	Range	20m MAX
Beam Angle	360°	Time	10sec-7min
Ambient Light	10Lux-2000Lux	Material	Plastic
Size	113x113x58mm	IP Rating	IP54

SKU: 7323
Color: White



PIR MOTIONSENSOR			
Max Power -300W LED			
Input Voltage	AC220-240V 50Hz	Range	8m MAX
Beam Angle	360°	Time	10sec-7min
Ambient Light	10Lux-2000Lux	Material	Plastic
Size	Ø80x62mm	IP Rating	IP20
SKU	7312		
Color	White		

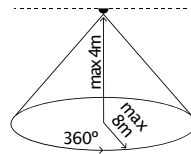

SMOKE ALARM			
85dB			
Input Voltage	DC 9V	Material	Plastic
Alarm Sound	85dB (3m)	IP Rating	IP20
Working Temp.	-20°C/+40°C	Low battery alert	7-15days
Size	Φ132x40.5	*Battery not included	
SKU	7325		
Color	White		



PIR MOTIONSENSOR			
Max Power -300W LED			
Input Voltage	AC220-240V 50Hz	Range	2-16mMAX
Beam Angle	300°	Time	10sec-7min
Ambient Light	10Lux-2000Lux	Material	Plastic
Size	156x117mm	IP Rating	IP44
SKU	7313		
Color	White		

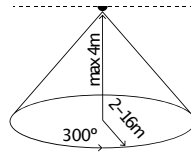

PIR MOTIONSENSOR			
Max Power -300W LED			
Input Voltage	AC220-240V 50Hz	Range	12m MAX
Beam Angle	180°	Time	10sec-7min
Ambient Light	10Lux-2000Lux	Material	Plastic
Size	85x79x94mm	IP Rating	IP44
SKU	7302	7301	
Color	Black	White	

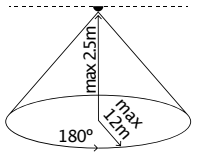

PIR MOTIONSENSOR			
Max Power -400W LED			
Input Voltage	AC220-240V 50Hz	Range	9m MAX
Beam Angle	160°	Time	10sec-7min
Ambient Light	10Lux-2000Lux	Material	Plastic
Size	79x79x43mm	IP Rating	IP20
SKU	7322		
Color	White		

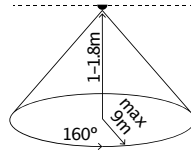

PIR MOTIONSENSOR			
Max Power -200W LED			
Input Voltage	AC220-240V 50Hz	Range	12m MAX
Beam Angle	180°	Time	10sec-7min
Ambient Light	10Lux-2000Lux	Material	Plastic
Size	79x56x68mm	IP Rating	IP54
SKU	7307	7306	
Color	Black	White	

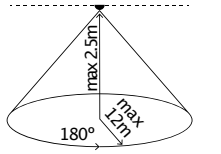

PIR MOTIONSENSOR			
Max Power -100W LED			
Input Voltage	AC220-240V 50Hz	Range	9m MAX
Beam Angle	160°	Time	10sec-7min
Ambient Light	10Lux-2000Lux	Material	Plastic
Size	80x80x36mm	IP Rating	IP20
SKU	7303		
Color	White		

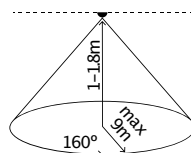

PIR MOTIONSENSOR			
Max Power -400W LED			
Input Voltage	AC220-240V 50Hz	Range	16m MAX
Beam Angle	180°	Time	10sec-7min
Ambient Light	10Lux-2000Lux	Material	Plastic
Size	118x70x125mm	IP Rating	IP54
SKU	7318		
Color	Black		

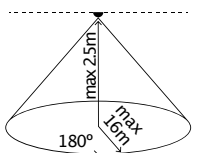



MICROWAVESENSOR			
Max Power -300W LED			
Input Voltage	AC220-240V 50Hz	Range	6m MAX
Beam Angle	180°/300°	Time	10sec-15min
Wave Radar	5.8Ghz	Material	Plastic
Size	75x47mm	IP Rating	IP20
SKU	7315		
Color	White		

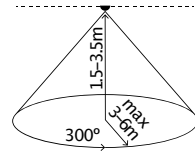

PIR MOTIONSENSOR			
Max Power -100W LED			
Input Voltage	AC220-240V 50Hz	Range	3m MAX
Beam Angle	120°	Time	10sec-7min
Ambient Light	10Lux-2000Lux	Material	Plastic
Size	67x45x26mm	IP Rating	IP44
SKU	7319		
Color	White		

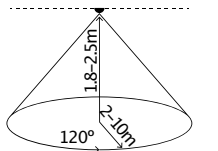

MICROWAVESENSOR			
Max Power -300W LED			
Input Voltage	AC220-240V 50Hz	Range	10m MAX
Beam Angle	180-360°	Time	10sec-15min
Wave Radar	5.8Ghz	Material	Plastic
Size	73x42x27mm	IP Rating	IP20
SKU	7316		
Color	White		

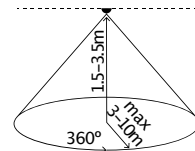

MINI PIR MOTIONSENSOR			
Max Power -100W LED			
Input Voltage	AC220-240V 50Hz	Range	9m MAX
Beam Angle	120°	Time	10sec-7min
Ambient Light	10Lux-2000Lux	Material	Plastic
Size	79x79x43mm	IP Rating	IP20
SKU	7309		
Color	White		

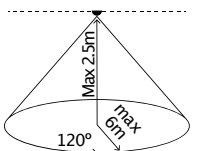

NEW



MICROWAVESENSOR			
Max Power -1000W LED			
Input Voltage	AC120-277V 50Hz	Range	15m MAX
Beam Angle	360°	Time	10sec-30min
Wave Radar	5.8Ghz	Material	Plastic
Size	115x83x79mm	IP Rating	IP65
SKU	7324		
Color	White		

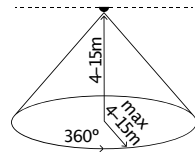

Short Distance IR			
Max Power -200W LED			
Input Voltage	AC220-240V 50Hz	Range	5-6cm
Beam Angle	180°	Time	10sec-7min
Ambient Light	10Lux-2000Lux	Material	Plastic
Size	70x50x105mm	IP Rating	IP20
SKU	7304		
Color	White		

NEW



2in1PRESENCE SENSOR			
Max Power -1000W LED			
Input Voltage	AC220-240V 50Hz	Range	6m MAX
Beam Angle	180/360°	Time	10sec-15min
Wave Radar	24Ghz	Material	Plastic
Size	Ø93x36mm	IP Rating	IP20
SKU	7326		
Color	White		

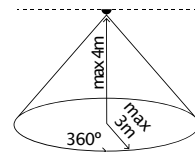

LIGHT CONTROLSENSOR			
6A MAX			
Input Voltage	AC220-240V 50Hz	Power	6A Max
Working Temp.	-30°C/+50°C	Class	II
ON/OFF	10Lux />40Lux	Material	Plastic
Size	70x50x105mm	IP Rating	IP44
SKU	7314		
Color	White/Blue		



Power Strips

POWER STRIP
Standard

Input Voltage AC230V 50Hz
Max Current 16A
Material Plstic ,Copper



Sockets	3	4	5
Size	180x55x40mm	220x55x40mm	260x55x40mm

SKU	7601	7602	7603	7604	7605	7606
Cable	1.5m	3m	1.5m	3m	1.5m	3m



POWER STRIP
With Switch

Input Voltage AC230V 50Hz
Max Current 16A
Material Plstic ,Copper



Sockets	3	4	5
Size	205x55x40mm	250x55x40mm	300x55x40mm

SKU	7607	7608	7609	7610	7611	7612
Cable	1.5m	3m	1.5m	3m	1.5m	3m



POWER STRIP
With Switch and USB-A

Input Voltage AC230V 50Hz
Max Current 16A
Material Plstic ,Copper



Sockets	3	5
Size	260x55x40mm	340x55x40mm

SKU	7615	7616
Cable	1.5m	1.5m



POWER STRIP
With Switch and USB-A ; USB-C

Input Voltage AC230V 50Hz
Max Current 16A
Material Plstic ,Copper

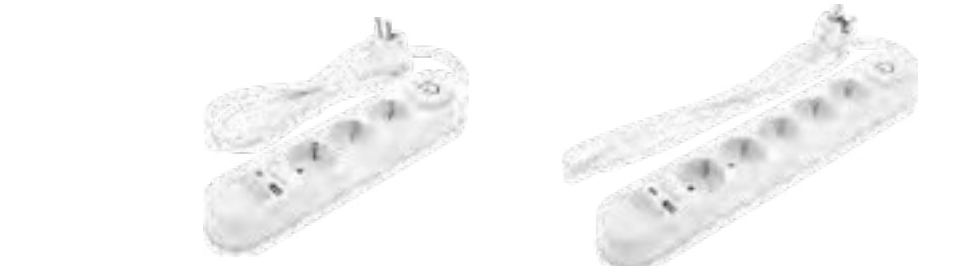

Sockets	3	5
Size	290x50x40mm	360x50x40mm

SKU	7617	7618
Cable	1.5m	1.5m



POWER STRIP
With Switch -Waterproof

Input Voltage AC230V 50Hz
Max Current 16A
Material Plstic ,Copper



Sockets	4	6
Size	350x75x50mm	470x75x50mm

SKU	7613	7614
Cable	5m	10m



CABLE REEL

Input Voltage AC230V 50Hz
Max Current 16A
Sockets 4



Reel:	1100W(4.35A)	1100W(4.8A)
Unreel:	3200W(13.91A)	3200W(13.91)

SKU	7624	7623
Cable	10m	25m



Garden Power Strip
with GroundSpike

Input Voltage AC230V 50Hz
Max Current 16A
Cable type H05VV-F3G



Sockets	2	2
Timer		Timer

SKU	7625	7626
Cable	5m	5m



POWER PLUG/SOCKET

Input Voltage AC230V 50Hz
 Max Current 16A
 Material Plstic ,Copper



EU plug	Male	Femele	Male	Female
IP Rating	IP44	IP44	IP20	IP20
SKU	7631	7632	7633	7634
Color	Black	Black	White	White

POWER EXTENSION CORD

4x Sockets and 2xUSB TYPE-A



Power Supply : 220-240V
 Current: Max. 16A
 Schuko Sockets: 4
 USB Ports: 2xUSB Type A
 USB Charger Output: 5VDC/2.1A
 Cable Length: 1.4m(3x1.5mm²)

SKU	7643
Color	Gray/White



POWER ADAPTER

Input Voltage AC230V 50Hz
 Max Current 16A
 Material Plstic ,Copper



Sockets	2	3	2	UK toEU
IP Rating	IP44	IP20	IP20	IP20
SKU	7637	7636	7635	9517
Color	Black	White	White	Material Cooper
				9518
				Iron



CHARGING HUB

USB 5xTYPE-A and 1xTYPE-C

Type-CPort Output:
 5.0V DC, 3.0A
 9.0V DC, 2A 12VDC, 1.5A, Max.18W

USB Output(A1):
 5.0V DC, 3A, Max. 15W
 9.0V DC, 2A, Max.18W
 12V DC, 1.5A, Max 18W

USB Output(A2/A3/A4/A5):
 5.0V DC, 2.4A, Max. 24W
 All Ports Total -42W Max

SKU	7641
Color	White



POWER EXTENSION CORD

Input Voltage AC250V 50Hz
 Max Current 16A
 Material Plstic ,Copper



Sockets	1	1
IP Rating	IP20	IP20
SKU	7621	7622
Cabel	10m	20m



NEW



CHARGING HUB

USB 2xTYPE-A and 4xTYPE-C

Type-CPort Output:
 5.0V DC, 3.0A
 9.0V DC, 3A 12VDC, 3A,
 12V DC, 3A 20VDC 5A
 Max100W

Type-CPort Output:(20W)
 5.0V DC, 3A,
 9.0V DC, 2.22A,
 12V DC, 1.67A,

Type-APort Output:(18W)
 5.0V DC, 3A,
 9V DC,2A 12VDC,1.5A

SKU	9505
Color	Black



POWER CORD

for Power Supplies

Input Voltage AC230V 50Hz
 Material Plstic ,Copper



Max Current	2.5A	10A	10A
Type	2 PIN	3 PIN	3 PIN
SKU	6040	6041	6042
Cable	1m	1m	1m



Multi-ChargerUSB HUB

USB 4xTYPE-A and 1xTYPE-C

Type-CPort Output:
 5.0V DC, 3.0A
 9.0V DC, 2.2A 12VDC, 1.67A, Max.18W

USB Output(A1):
 5.0V DC, 3A, Max. 15W
 9.0V DC, 2A, Max.18W
 12V DC, 1.5A, Max 18W

USB Output(A2/A3/A4):
 5.0V DC, 2.4A, Max.12W
 All Ports Total -32WMax

SKU	7642
Color	White



WIRELESS CHARGER3in1

For Phone /Pods /Watch

Apple Iphone /AirPods /iWatch
Samsung Phone /Buds /Watch
Compact Design



SKU	For iPhone 9500	For Android 9501
-----	--------------------	---------------------

3in1 MULTIFUNCTION DESK LAMP

Wireless Charging



SKU	9512
-----	------

CHARGING STAND 6in1

Match multiple devices

For Phones , iWatch , AirPods



SKU	Black 9502	White 9503
-----	---------------	---------------

WIRELESS CHARGERPAD

Qi Standard

Input: DC5V 2A
Output DC 9V 1.2A
Length 1m



SKU	Black 9508	White 9509
-----	---------------	---------------

WIRELESS CHARGINGCLOCK

Supports iOS and Android



SKU	9514
-----	------

CAR WIRELESS CHARGERSTAND

10W Max Power



SKU	Gold 9506	Silver 9507
-----	--------------	----------------



SOLAR BLUETOOTH SPEAKER +LIGHT

Solar Panel Power: 5V /3.5W

Lumens: 380lm
Battery: DC 3.7V 6A
Light Color 3000K-6000K CCT
IP Rating: IP44



SKU	228	224	223
Color	Black	Camouflage	Yellow

CCTSELFIE RING LIGHT

10W 5V USB -Dimmable

Watts: 10W
Input Voltage: 5V USB
Flux: 800lm
Beam Angle: 120°
Dimmable: Yes
IP Rating: IP20



SKU	9515
-----	------

WORLD ADAPTER

All Standards

NEW

Socket : UK, EU, AU
IP Rating: IP20



SKU	9513
-----	------

QUICKCHARGER PD

36W Max Power

Power: 36W Max
 Outlets: 3 USB-A, 1 USB-C
 Input: AC100-240V 50Hz



Black
 White
 SKU 9510 9511

QUICKCHARGER PD NEW

65W Max Power

Power: 65W Max
 Outlets: 2 USB-C, 1 USB-A
 Input: AC100-240V 50Hz



SKU 9531

USB -HUB TYPE A

4USB Ports

Input: USB-A 3.0
 Output: USB-A 3.0
 Size: 100x45x18mm
 Cable: 165mm



SKU 9525

USB -HUB TYPE C

4USB Ports

Input: USB-A 3.0
 Output: USB-A 3.0
 Size: 100x45x18mm
 Cable: 165mm



SKU 9526

TYPE-C to TYPE-C NEW

Cable 3A

Length: 1m



SKU 9519

TYPE-C to TYPE-C NEW

Cable 6A

Length: 1m



SKU 9520

USB-HUBTYPE C

5 in 1

Input: RJ45, 2xUSB 3.0, HDMI 2.0 (4K 60Hz), PD in
 Output: USB-C
 Size: 113x43x14mm
 Material: Aluminium



SKU 9521

USB-HUBTYPE C

4 in 1

Input: RJ45, USB 3.0, HDMI 1.4 (4K 30Hz), PD in
 Output: USB-C
 Size: 85x46x15mm
 Material: Aluminium



SKU 9522

BLUETOOTHFM TRANSMITTER

Car Charger with MP3 Player

Input: DC12-24V
 Output: DC 5V
 FM Transmit: FM87.5MHz-108.0MHz
 Outlets: 2 USB-A/3.5A(max)



SKU 9504

MAGNETIC USB CABLE 3in1

3Heads -TypeC, MicroUSB, Apple

Length: 1m



SKU 9516

NETWORK ADAPTER

LAN to USB-A

Input: RJ45
 Output: USB-A
 Size: 57x28x15mm
 Transfer rate: 1000Mbps/s



SKU 9523

NETWORK ADAPTER

LAN to USB-C

Input: RJ45
 Output: USB-C
 Size: 57x28x15mm
 Transfer rate: 1000Mbps/s



SKU 9524



POWER BANK –WATERPROOF
10000 mAh

Battery: 10000mAh
 Rated Power: 37Wh/3.7V
 Input Micro: 5V/2A
 Input Type-C: 5V/3A
 Size: 159x78x19.5mm

Output: USB1/2 t: 5V/3A
 Output: Type-C: 5V/3A
 Solar Panel: 1.2W
 Flashlight: 2W LED

SKU	7691
Color	Black



POWER BANK –WATERPROOF
20000 mAh

Battery: 20000mAh
 Rated Power: 74Wh/3.7V
 Input Micro: 5V/2A
 Input Type-C: 5V/3A
 Size: 167x86x33.5mm

Output: USB1/2 t: 5V/3A
 Output: Type-C: 5V/3A
 Solar Panel: 1.2W
 Flashlight: 4W LED

SKU	7692
Color	Black



POWER BANK
10000 mAh

Battery: 10000mAh
 Rated Power: 37Wh/3.7V
 Input Micro: 5V/2A|9V/2A|12V/1.5A
 Input Type-C: 5V/3A|9V/2A|12V/1.5A

Output: USBA 4.5V/5A|5V/4A|9V/2A
 Output: Type-C5V/3A|9V/2A|12V/1.5A
 Size: 140x69x15.5mm

SKU	7694	7693
Color	Black	White



POWER BANK
20000 mAh

Battery: 20000mAh
 Rated Power: 74Wh/3.7V
 Input Micro: 5V/2A|9V/2A|12V/1.5A
 Input Type-C: 5V/3A|9V/2A|12V/1.5A

Output: USBA 4.5V/5A|5V/4A|9V/2A
 Output: Type-C5V/3A|9V/2A|12V/1.5A
 Size: 145x69x27.5mm

SKU	7695
Color	Black



SMART CAMERA ROBOTICVACCUUM CLEANER
Gyroscope Navigation



SKU 752

works with the Google Assistant works with alexa

ANTI-DROP SENSOR
Keep machinesafety away from stairs

ANTI-COLLISION SENSORS
Effective protect machine and furniture

SMART GYRO ROBOTICVACCUUM CLEANER
Gyroscope Navigation Multiple Cleaning Modes



SKU 753

works with the Google Assistant works with alexa

ROADROVER WHEELS
Climbing ability reach 2cm. With cross-country wheel. Easy to crossing the obstacle.

10 PAIRS OF INFRARED ANTI-COLISIONSENSORS

AUTOCLEANING ROBOTIC VACUUM CLEANER
10W 5V USB –Dimmable



SKU 754

STRONS SUCTION
Up to 1000PA nodust can hide from it

VARIOUS GROUND TYPE APPLICATION
Suitable for various floor tyre low pile carpet,tile, wood floor,etc.



SMART CAMERA BULB
WiFi E27

Video resolution: HD
 Frame rate: 25fps
 View angle: 360 degrees (Horizontal)
 90 degrees (Vertical)
 Motion detection: About 5meters
 Night vision: About 5 meters
 Max memory: Up to 128Gb(Not Include)
 App:JXLCAM

SKU 227

SKU 733



AIR PURIFIER -7 STAGE +HUMIDIFIER
Air Purification +Humidifier +UV Lamp +Ionizer +WiFi

CADR(PM2.5): 450m3/h
 Power: 85W
 Area: 50m2
 Size: 400x230x620mm
 Purification: Pre-filter,Cold-catalyst,Formaldehyde removal filter(Honeycomb activated carbon filter Optional),Antibacterial filter, UV Sterilization, HEPA filter, Anion release.



SMART CAMERA BULB
WiFi

Video resolution: HD
 Frame rate: 25fps
 View angle: 360 degrees (Horizontal)
 90 degrees (Vertical)
 Motion detection: About 5meters
 Night vision: About 5 meters
 Max memory: Up to 128Gb(Not Include)
 App:JXLCAM

SKU 244

SKU 732



AIR PURIFIER -6 STAGE +HUMIDIFIER
Air Purification +Humidifier +UV Lamp +Ionizer

CADR(PM2.5): 300m3/h
 Power: 65W
 Area: 38m2
 Size: 360x195x565mm
 Purification: Cold-catalyst,Formaldehyde removal filter (Honeycomb activated carbon filter Optional),Antibacterial filter, UV Sterilization, HEPA filter,Anionrelease.



WINDOW CLEANING ROBOT
+

Cleaning speed: 2minutes /m2
 Power: 80W
 Size: 300x150x120m
 Cleaning Modes: 3modes

SKU 757

SKU 731



AIR PURIFIER -6 STAGE
Air Purification UV Lamp +Ionizer

CADR(PM2.5): 150m3/h
 Power: 43W
 Area: 30m2
 Size: 330x180x525mm
 Purification: Cold-catalyst,Formaldehyde removal filter (Honeycomb activated carbon filter Optional),Antibacterial filter, UV Sterilization, HEPA filter,Anionrelease



WINDOW CLEANING ROBOT
+

Cleaning speed: 2minutes /m2
 Power: 80W
 Size: 250x250x9.5m
 Cleaning Modes: 3modes
 USP: 20min

SKU 758

SKU 734



AIR PURIFIER -7 STAGE
Air Purification UV Lamp +Ionizer

CADR(PM2.5): 320m3/h
 Power: 80W
 Area: 40m2
 Size: 370x195x605mm
 Purification: Pre-filter,Cold-catalyst,Formaldehyde removal filter(Honeycomb activated carbon filter Optional),Antibacterial filter, UV Sterilization, HEPA filter,Anionrelease.



NEW



PORTABLE PARTYSPEAKER
Bluetooth 2x8.0 inch

OutputPower: 20W RMS /400W P.M.P.O
Version BT : V5.0+EDR
Function: BT/FM/USB/TF/AUX/MIC IN/TWS
USB MP3 Player: YES
Remote Control: YES
Woofer : 8**2
Channel : Stereo
Signal to noise ratio : ≥80dB
MIC input: YES
AUX 3.5mm Input: YES
USB charging: DC 5V
Charging Time : 5-6Hours
Playtime : 2-4Hours
Battery capacity : 2400mAh
Size : 250x245x615mm

SKU 9551



NEW



PORTABLE PARTYSPEAKER
Bluetooth 2x3.0 inch

OutputPower: 2x6WRMS /150W P.M.P.O
Version BT : V5.0
Function: BT/FM/USB/TWS
Woofer : 3**2
Signal to noise ratio : ≥80dB
5LightingModes : YES
USB MP3 Player: YES
USB charging: DC 5V
Charging Time : 5-6Hours
Playtime : 2-4Hours
Battery capacity : 1200mAh
Size : 128x128x280mm

SKU 9554



NEW



PORTABLE PARTYSPEAKER
Bluetooth 15 inch

OutputPower: 2x20WRMS /800W P.M.P.O
Version BT : V5.0+EDR
Function: BT/FM/USB/TF/AUX/MIC IN/TWS
USB MP3 Player: YES
Remote Control: YES
Woofer : 15"
Channel : Stereo
Signal to noise ratio : ≥80dB
MIC input: YES
AUX 3.5mm Input: YES
USB charging: DC 9V
Charging Time : 5-6Hours
Playtime : 2-4Hours
Battery capacity : 7.4V 3000mAh
Size : 420x330x610mm

SKU 9552



NEW

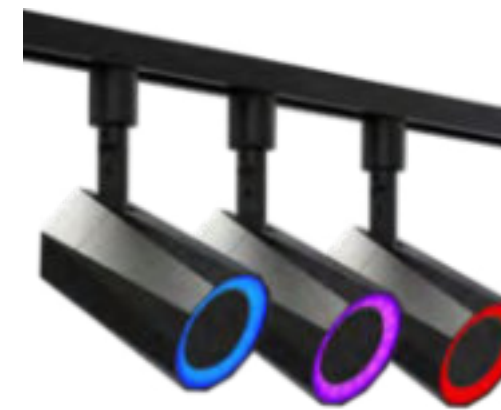

LED RGB TRACKLIGHT SPEAKER
Bluetooth -Remote Control

Bluetooth: 5.4
Working Distance: 10m
Transmission Power: 4dbm
IP Rating: IP20
DriverSpecification: φ52mm6W RMS
Peak power: 11W
Material: Plastic
Body Color: Black
On/Off Cycle: 25000x
Frequency response: 50Hz-20kHz
Life Span: 25 000H
S/N Span: >75db
Working Voltage: AC90-245V

For 4-LineTracks

SKU 15107



NEW



2 PCS

PORTABLE PARTYSPEAKER
Bluetooth 2x8.0 inch

OutputPower: 2x20WRMS /800W P.M.P.O
Version BT : V5.0+EDR
Function: BT/FM/USB/TF/AUX/MIC IN/TWS
USB MP3 Player: YES
Remote Control: YES
Woofer : 8**2
Channel : Stereo
Signal to noise ratio : ≥80dB
MIC input: YES -2 Pcs
AUX 3.5mm Input: YES
USB charging: DC 9V
Charging Time : 5-6Hours
Playtime : 2-4Hours
Battery capacity : 7.4V 3600mAh
Size : 315x277x667mm

SKU 9553



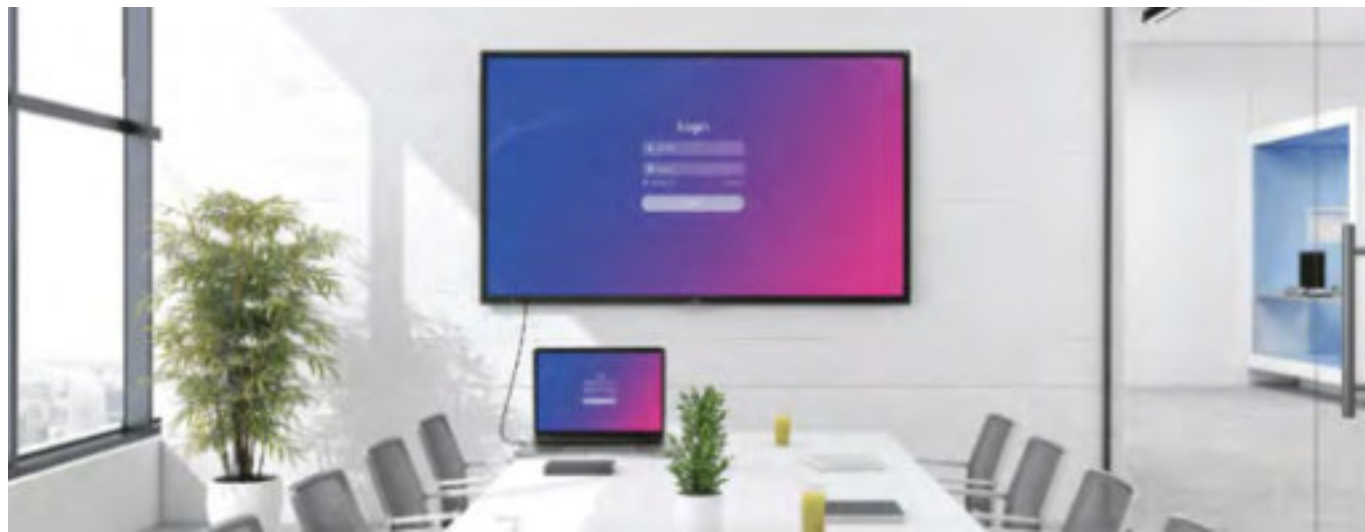

WHITE BOARD –Touch Pen and Remote
Interactive Displays 65" /86"

Display resolution 4K 60Hz ULTRA HD 3840x2160
OperatingSystem Android
Display 65" 86"
Port Type HDMI /USB /LAN
Wi -Fi YES
Brightness 350cd/m2
Speakers 8Ω 12Wx2
Contrast (Typ) 1200:1
Color gamut NTSC 72%



SKU	65" Inch	86" Inch	Floor stand	Wall mounted
	10673	10674	10675	10676



ANDROID TOUCH SCREEN
43" Floor Stand /43" K-Shape

Display resolution 2K QUAD HD
OperatingSystem Android
Display 42"
Port Type HDMI /DP /USB /LAN
Wi -Fi YES
Touch points 10 points touch
Brightness 450cd/m2
Speakers 8Ω 5Wx2



SKU	Floor Stand	K-Shape
	10671	10672



SKU	Page №	SKU	Page №	SKU	Page №	SKU	Page №	SKU	Page №	SKU	Page №	SKU	Page №	SKU	Page №
221	54	592	330	1343	38	1519	35	1847	40	1982	31	2088	323	2444	140
222	96	593	330	1344	37	1527	35	1849	37	1983	31	2089	309	2445	140
223	347	594	332	1345	37	1528	35	1854	48	1984	170	2090	309	2446	140
224	347	595	332	1346	37	1529	35	1855	48	1985	170	2091	309	2447	140
225	54	596	330	1351	36	1530	35	1856	48	2001	67	2092	309	2448	140
226	54	597	330	1352	36	1531	34	1857	48	2002	67	2093	86	2449	140
227	352	598	330	1353	36	1532	34	1858	48	2003	67	2094	86	2450	140
228	347	599	330	1354	36	1533	34	1859	48	2004	67	2095	87	2451	140
229	54	731	353	1355	36	1534	34	1860	50	2005	67	2096	87	2452	140
230	95	732	353	1356	36	1535	34	1861	50	2006	67	2231	134	2453	140
231	95	733	353	1357	36	1536	34	1862	50	2007	67	2232	134	2454	140
232	95	734	353	1358	36	1541	34	1863	50	2008	67	2235	134	2455	140
233	94	752	351	1359	36	1542	34	1864	50	2009	61	2236	134	2456	140
234	94	753	351	1360	36	1543	34	1865	50	2010	61	2237	134	2470	141
235	94	754	351	1361	36	1601	28	1866	50	2011	61	2238	134	2471	141
236	94	757	352	1362	36	1602	28	1867	50	2012	61	2241	134	2472	141
237	92	758	352	1363	36	1603	28	1868	50	2013	57	2242	134	2473	141
238	92	856	331	1364	36	1616	28	1869	50	2014	57	2243	134	2474	141
239	92	863	330	1365	36	1617	28	1872	43	2015	57	2244	134	2475	141
240	95	864	330	1401	41	1635	29	1876	38	2016	57	2245	134	2476	141
241	95	865	330	1402	41	1636	29	1877	38	2017	254	2246	134	2477	141
242	95	866	333	1403	41	1637	29	1878	38	2018	254	2247	134	2478	141
243	95	867	333	1404	41	1638	29	1879	46	2019	254	2248	134	2479	141
244	352	868	333	1405	41	1639	29	1880	46	2020	254	2249	134	2480	141
249	96	872	333	1406	41	1640	29	1884	40	2021	68	2250	134	2481	141
250	96	873	333	1407	41	1644	29	1885	40	2022	68	2251	134	2482	141
251	90	874	333	1408	41	1645	29	1886	40	2023	68	2252	134	2483	141
252	90	879	330	1409	41	1646	29	1887	46	2024	68	2253	134	2484	141
253	90	1066	28	1410	52	1647	29	1888	46	2025	68	2254	134	2485	141
254	90	1067	28	1411	52	1648	29	1889	46	2026	68	2255	134	2486	141
255	90	1068	28	1412	52	1651	28	1890	46	2027	67	2256	134	2487	141
256	90	1164	30	1413	53	1652	28	1893	46	2028	67	2257	134	2488	141
260	91	1168	30	1414	53	1653	28	1896	46	2029	66	2258	134	2489	141
261	89	1169	30	1415	53	1654	29	1899	48	2030	66	2326	255	2490	141
262	89	1170	30	1416	51	1655	29	1901	32	2031	61	2335	140	2491	141
263	89	1191	30	1417	52	1656	29	1902	32	2032	61	2336	140	2492	141
264	89	1192	30	1418	51	1701	37	1903	32	2033	61	2348	140	2493	141
265	89	1193	30	1422	41	1702	37	1904	32	2034	61	2349	140	2494	141
266	89	1194	30	1423	41	1703	37	1905	32	2035	61	2377	123	2495	141
267	90	1195	30	1424	41	1704	37	1906	32	2036	61	2385	123	2496	141
268	90	1196	30	1425	41	1705	37	1907	32	2037	61	2387	123	2497	141
269	90	1263	33	1426	41	1706	37	1908	32	2038	61	2389	123	2498	141
270	90	1265	33	1427	41	1710	38	1909	32	2039	66	2396	120	2499	141
271	88	1266	33	1428	41	1711	38	1910	55	2040	66	2401	135	2501	160
272	88	1267	33	1429	41	1718	36	1914	55	2041	66	2402	135	2502	160
273	88	1269	33	1430	41	1719	36	1915	55	2042	66	2403	135	2503	160
274	88	1270	33	1435	42	1720	36	1916	55	2043	66	2404	135	2504	160
275	88	1271	33	1436	42	1721	36	1917	55	2044	66	2405	135	2505	160
501	329	1272	33	1437	42	1722	36	1918	55	2045	61	2406	135	2506	160
502	329	1273	33	1438	43	1723	36	1919	55	2046	61	2407	135	2535	137
507	329	1277	125	1439	43	1724	36	1920	55	2047	61	2408	135	2536	137
515	329	1305	49	1440	43	1725	36	1921	55	2048	61	2409	135	2537	137
516	329	1306	49	1463	42	1726	36	1922	55	2049	61	2410	135	2538	137
517	329	1308	48	1464	42	1748	36	1923	55	2050	59	2411	135	2539	137
518	333	1309	48	1465	42	1749	36	1925	31	2051	59	2412	135	2540	137
519	333	1310	48	1469	52	1750	36	1926	31	2052	59	2413	135	2541	137
550	329	1311	48	1470	52	1761	30	1927	31	2060	62	2414	135	2542	137
551	329	1312	48	1471	52	1762	30	1935	32	2061	62	2415	135	2581	143
557	333	1313	48	1472	52	1763	30	1936	32	2062	62	2416	135	2582	143
565	331	1314	48	1473	52	1764	30	1937	32	2063	62	2417	135	2583	143
566	331	1315	48	1474	52	1765	30	1938	32	2064	63	2418	135	2584	143
567	331	1316	48	1475	52	1766	30	1939	32	2065	63	2419	135	2585	143
568	331	1317	48	1476	52	1767	31	1940	32	2066	63	2420	135	2586	143
571	332	1318	48	1477	52	1768	31	1944	32	2067	63	2421	135	2587	143
572	332	1319	48	1478	52	1769	31	1945	32	2068	62	2422	135	2588	133
573	332	1320	48	1479	52	1770	31	1946	32	2069	62	2423	135	2589	133
578	333	1321	48	1480	53	1772	31	1947	32	2070	65	2424	135	2590	137
579	333	1322	49	1481	53	1773	31	1950	55	2071	65	2431	140	2591	137
580	329	1323	48	1482	53	1790	47	1951	55	2072	65	2432	140	2592	137
581	329	1324	49	1487	43	1791	47	1952	55	2073	65	2433	140	2593	137
582	329	1325	50	1488	43	1792	47	1953	55	2074	65	2434	140	2594	137
583	329	1326	50	1489	43	1793	47	1957	33	2075	65	2435	140	2595	137
584	329	1327	37	1490	51	1794	49	1958	33	2080	68	2436	140	2596	137
585	329	1328	37	1491	51	1795	49	1959	33	2081	68	2437	140	2597	137
586	332	1329	37	1492	51	1796	49	1960	33	2082	57	2438	140	2598	133
587	332	1336	37	1499	43	1841	40	1961	33	2083	57	2439	140	2599	133
588	332	1337	37	1511	210	1842	40	1962	33	2084	327	2440	140	2701	120
589	332	1338	37	1516	35	1843	40	1963	33	2085	323	2441	140	2702	120
590	331	1341	38	1517	35	1845	40	1964	33	2086	323	2442	140	2703	120
591	332	1342	38	1518	35	1846	40	1981	31	2087	323	2443	140	2704	120

OPTONICA

LED Lighting for everyone

